



Merchant MEDIA 2

Operator & Technical Manual

Table of Contents

• Compliance Requirements	Page
• Specifications	Page
• Cautions & Definitions	Page
• Inspection & Installation	Page
• Daily Cleaning	Page
• Initial Start up	Page
• The Selection Process	Page
• The Touch Screen	Page
• Access Service Mode	Page
• How do I Access the Service Modes	Page
• Service Mode Chart	Page
• Troubleshooting Charts	Page
• Wiring Diagram	Page
• Software License Information	Page

Compliance Requirements

LOCATION OF MANUFACTURER:

- All machines are built at the Crane Merchandising Systems manufacturing facility, located at 3330 Crane Way, Williston SC 29853, USA

DATE OF MANUFACTURE:

- Date of manufacture can be determined by viewing the Manufacturing Date on the Serial Number decal, located on the top left rear corner of the back of the machine cabinet.

PERMITTED & NON PERMITTED USES OF THIS MACHINE

- This machine is designed to dispense pre-packaged food, candy, beverage, snack and similar products. Use of unwrapped food products is not permitted.
- It is not permitted to use this machine outdoors, or in an environment where flammable or explosive vapors are present.
- This machine is not designed, nor should it be used to dispense flammable or explosive items, nor any other item that could not be safely dispensed by dropping it into the delivery bin.
- This machine is not suitable for installation in an area where a water jet could be used.
- This appliance is not to be used by persons (including children) with a reduced physical, sensory or mental capabilities, or lack of experience and knowledge, unless they have been given supervision or instruction. Children must be supervised and are not to play with the appliance.

Nutritional Content Information

- Crane Merchandising Systems is providing the nutritional content information, based on information provided by the product manufacturers, and Crane MS cannot accept responsibility for content created by others.

Compliance Requirements

All models are built to meet or exceed all applicable standards, including but not limited to:

- International (CE) Approvals to meet or exceed the below listed standards:
 - 83/23/EEC (93/68/EEC) Low Voltage Directive.
 - 89/336/EEC EMC Directive
 - EN 60335-1 Safety of household and similar electrical appliances.
 - DIN VDE 0700 T224 Safety requirements for Automatic and coin-operated machines and control devices for commercial use.
 - EN 55022 Class B Limits and methods of measurements of Radio interference characteristics of information technology equipment.
 - IEC 801-1 Electromagnetic compatibility for industrial-processing measurement and control. Part 1: General.
 - IEC 801-2 Part 2; Electrostatic discharge requirements for industrial process measurement control equipment.
 - IEC 801-3 Part 3; Radiated electromagnetic field requirements.
 - IEC 801-4 Part 4; Electrically fast transient.
 - IEC 801-5 Draft; Surge immunity requirement.
 - IEC 801-6 Draft; Immunity to conducted disturbances induced by radio frequency.
 - EN 50082-1 Generic immunity requirements; Residential, Commercial, Light industry.
- Machines built for the US Market meet or exceed the requirements for UL751 for ambient machines, and UL541 for chilled machines, and have also been reviewed and passed the NAMA Construction Standard, and are permitted to bear the NAMA Mark.

Compliance Requirements

- **NOISE LEVEL**
 - This machine operates at less than 70 db (A).
- **ACCEPTABLE AMBIENT OPERATING TEMPERATURE RANGE.**
 - This equipment was designed and tested to work properly in a temperature range of 10°C to 32°C (50°F to 90°F) in still air (45% Relative Humidity, non-condensing). Usage at ambient conditions outside the range of the testing may cause unacceptable appearance or performance.
- **STORAGE CONDITIONS**
 - The machine capable of being stored in a temperature range of -18°C to 68°C (0°F to 155°F). Storage temperatures below 0°C (32°F) require that the operator to take the required precautions to ensure that any water is removed from the condensate system prior to storage.
- **INDOOR USE ONLY**
 - This machine is designed to be used in an Indoor Setting only. Indoor Setting is defined as inside a structure constructed with four walls and a roof, and sufficiently protected from ambient conditions and not subjected to the effects of weathering. Any other usage is in direct violation of these instructions, and will void the warranty of the machine and its components.

Specifications

186 & 187 Ambient Snack

Specifications	Model 186 Domestic 4 wide Ambient	Model 186 Export 4 wide Ambient	Model 187 Domestic 6 wide Ambient	Model 187 Export 6 wide Ambient
Height	72 inches	183 cm	72 inches	183 cm
Width	32.8 inches	83.312 cm	43.75 inches	111.13 cm
Depth	38.5 inches	97.79 cm	38.5 inches	97.79 cm
Floor Space	8.8 Sq ft	.82 Sq Meter	11.7 Sq ft	1.09 Sq Meter
Container Size	52.8 Cu Ft.	1.50Cu Meter	70.2 Cu Ft.	1.99 Cu Meter
Shipping Weight	510 lbs	231 kg	610 lbs	276 kg
Voltage (AC)	120V	230V	120V	230V
Running Amperes	3A	1.5A	3A	1.5A
Refrigerant Charge	Not Applicable		Not Applicable	
Compressor size				
High Side Test Pressure				
Low Side Test Pressure				

Specifications

471 & 472 Combo

Specifications	Model 471 Domestic 4 wide Combo	Model 471 Export 4 wide combo	Model 472 Domestic 6 wide Ambient	Model 472 Export 6 wide Ambient
Height	72 inches	183 cm	72 inches	183 cm
Width	32.8 inches	83.312 cm	45.5 inches	115,57 cm
Depth	32.5 inches	82.55 cm	32.5 inches	82.55 cm
Floor Space	7.4 Sq ft	.69 Sq Meter	10.3 Sq ft	.96 Sq Meter
Container Size	44.4 Cu Ft.	1.26 Cu Meter	61.6 Cu Ft.	1.75 Cu Meter
Shipping Weight	629 lbs	285 kg	729 lbs	330 kg
Voltage (AC)	120V	230V	120V	230V
Running Amperes	8A	4A	8A	4A
Refrigerant Charge	7.5 oz	.213 kg	9.8 oz	.278 kg
Compressor size	1/3 hp	1/3 hp	Super 1/3	Super 1/3
High Side Test Pressure	250 psi	17.24 bar	250 psi	17.24 bar
Low Side Test Pressure	105 psi	7.24 bar	105 psi	7.24 bar

Cautions & Definitions

It is critical that all cautions and warnings be reviewed and complied with during the unpacking, installation, operation, and repair of this machine



CAUTION: This machine is designed for indoor usage only. Any other usage will void the Manufacturer's Warranty



CAUTION: Any procedure marked with the symbol at left requires that the Machine have the power applied and a shock hazard exists. Only a trained and authorized person should attempt these repairs.



CAUTION: It is important that this machine is hooked up to the proper voltage and polarity for your country. Use a Voltmeter to verify voltage and polarity. Should the reading be any different than a normal reading or if you are unsure of what the reading should be, contact an electrician.



CAUTION: Different countries may have unique plug arrangements. Ensure that the machine is properly grounded before operating. .



CAUTION: The power cord for all machines are of a type X attachment. If the power cord is damaged, it should be replaced by a trained service agent, or a similarly qualified person in order to avoid a hazard.

Cautions & Definitions



CAUTION: The machine is a heavy item. Ensure that sufficient personnel are available for lifting and transporting the machine. Use proper lifting procedures and equipment.



CAUTION: This machine is designed to dispense pre-packaged food, candy, beverage, snack and similar products. Use of unwrapped food products is in direct contradiction to these cautions.



CAUTION: If this machine is used to dispense perishable food, and local health codes require that the machine monitor the cabinet temperature, and prevent vending when the temperature exceeds a defined limit for a period of time, then the Health Code function must be enabled for those affected selections – see Health Code Setup



CAUTION: The electronic system components in this machine utilize static sensitive components. Precautions for handling sensitive devices should be observed when handling these items.

Inspection and Unpacking

The Merchant Media is assembled and packed so that a minimum amount of time is necessary for preparation to install it on location. The following steps are recommended to ensure correct unpacking.

- **Shipping Damage:** Thoroughly inspect the exterior of the carton for damage which may have occurred during shipment. Report any damage to delivering carrier and follow their instructions.
- Remove the remainder of the packing material. On machines shipped with the lock in place, the keys are taped inside the coin return.
- Removal of shipping boards: There are 2 methods available for removal of the shipping boards on the bottom of the machine, and they are dependent upon the style of packaging used: 2 flat shipping boards (Style A), or 2 L shaped assemblies (Style B).
- **Style A**
 - a) Using a motorized lifting device (i.e. a forklift) raise the machine to a comfortable working height and remove the leg levelers with the use of a socket or wrench (1 5/16"). Do this on one side at a time. After the front and rear leg levelers are removed, the shipping board can then be removed. Replace the leg levelers in the legs of the machine before lowering to the ground, OR
 - b) When using a pallet jack (non-motorized) insert a pry bar into the slit on the front and rear of the wooden boards, and twist the bar to force the boards to split apart, and remove from the machine. Screw the leg levelers all the way in before lowering the machine to the ground.
- **Style B**
 - a) Each of the 4 legs has a hex head screw securing the leg to the wooden pallet. Remove the screw from each leg, then using either a motorized lifting device, or a pallet jack, raise the machine sufficiently to slide the 2 assemblies out from under the machine and lower it to the floor.
- **NOTE:** On the machine, the weight concentration is toward the back of the cabinet. Trucking and lifting should be done from the back. **CAUTION** should be taken when trucking from side.
- On machines with lock in place, first unlock and turn handle to open door. When no lock is furnished, remove clip and turn handle. Swing door to its full open position.
- Remove all additional packing material from the machine.

Unpacking ADA Bin

Attention!

To avoid damage to the ADA delivery bin mechanism, remove the **SHIPPING Clips** from the bin sides prior to operating the ADA delivery bin!!!

The Shipping Clips must be installed any time the machine is moved or transported. Failure to do so could result in damage to the delivery bin

To tilt the bin down to access the shipping clips, swing the small latches on the top corners of the bin to release the bin.

Make sure you latch the bin after removing the shipping clips.



Bin Latch Locations



Shipping Location
(two bolts – back of bin sides on left and right)



Bin pulled out to access bolts

Moving the merchandiser through a narrow doorway

Note: If necessary, this Merchandiser can be moved through an opening as narrow as 30 inches (76.20cm) by removing the panels at the top and bottom of the cabinet.

Step 1- Remove the top Panel

1. Remove the screws that secure each end of the panel to the cabinet.
2. Pull the panel forward to remove it from the merchandiser.

Note: This only applies to an Ambient machines.

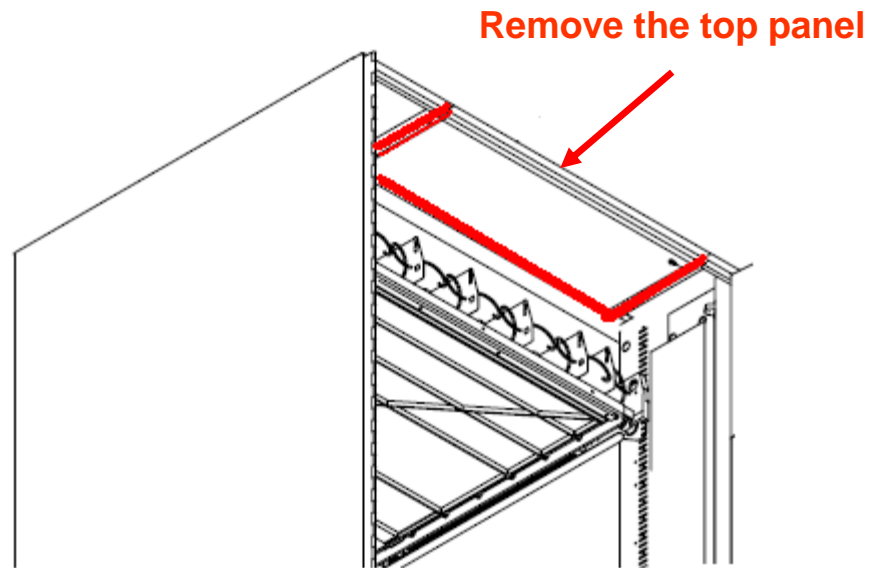

Figure 1



CAUTION: This procedure requires the use of tools, and should only be completed by a trained technician or operator.

Moving the merchandiser through a narrow doorway

Step 2

REMOVING THE LOWER PANEL AND DELIVERY BIN (Refer to Figures 2 and 3 at right.)

1. Open the slide-out monetary and the glass door. Locate the silver tab of the delivery bin latch on the lower delivery bin side of the monetary wall.
2. Lift the latch up to allow the delivery bin assembly to hinge down.
3. Lift up the delivery bin slightly and lift up on the drop rods to allow the rods to clear the stop brackets.
4. Slide the delivery bin assembly to the right to clear the hinges. The delivery bin assembly will not be attached to the machine.
5. Unhook the SureVend™ harness at the SureVend™ board, noting the wire routing.
6. Remove the screws that secure the bottom panel to the cabinet.
7. Pull the panel forward to remove it from the cabinet.

NOTE

To fit the merchandiser through some of the most narrow doorways, you may have to remove the trays. If you do, follow the procedure outlined on the following page.

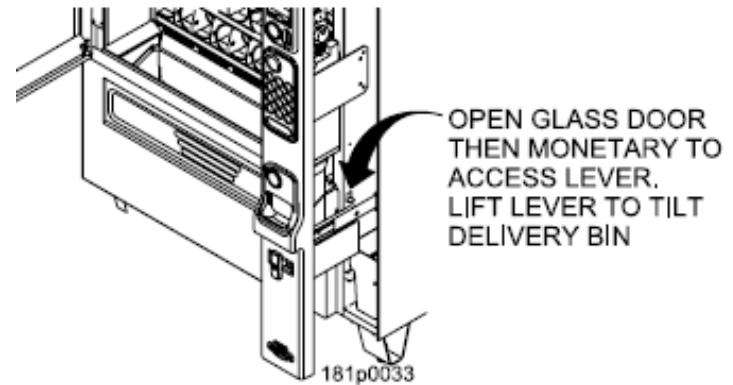

Figure 2

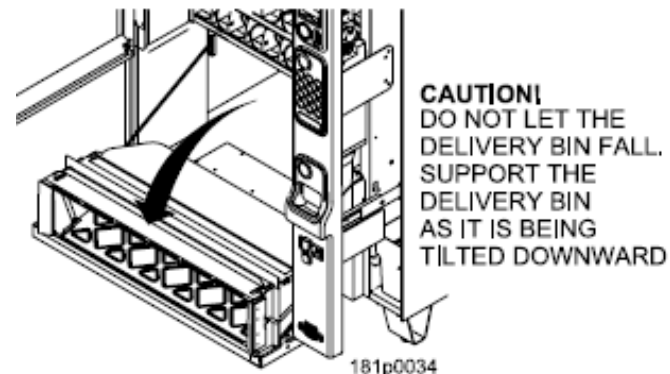
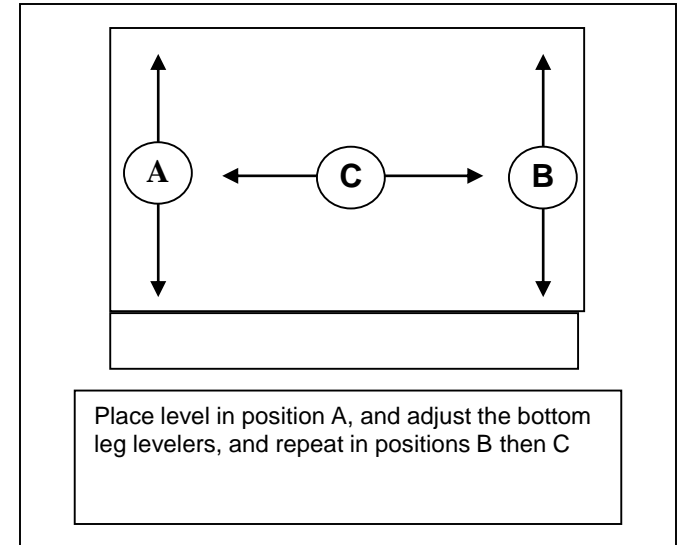

Figure 3

Installation

Leveling the unit

- **Leveling the Machine**
 - Leveling the machine on location is important for the proper function of the machine. There are four leveling screws in the legs of the machine to make any necessary adjustments. After positioning the machine, level it from front to rear and right to left directions. After leveling, turn front right (lock side) leveling screw in about one-half turn to drop this corner slightly to make the door easier to close and lock.



- **Clearance Requirements**

- It is necessary on all machines to have 25mm (1") clearance on the left side of the machine for the door to properly open to access the shelves.
- All chilled or refrigerated machines require 100mm (4") of clearance behind the machine for air circulation.

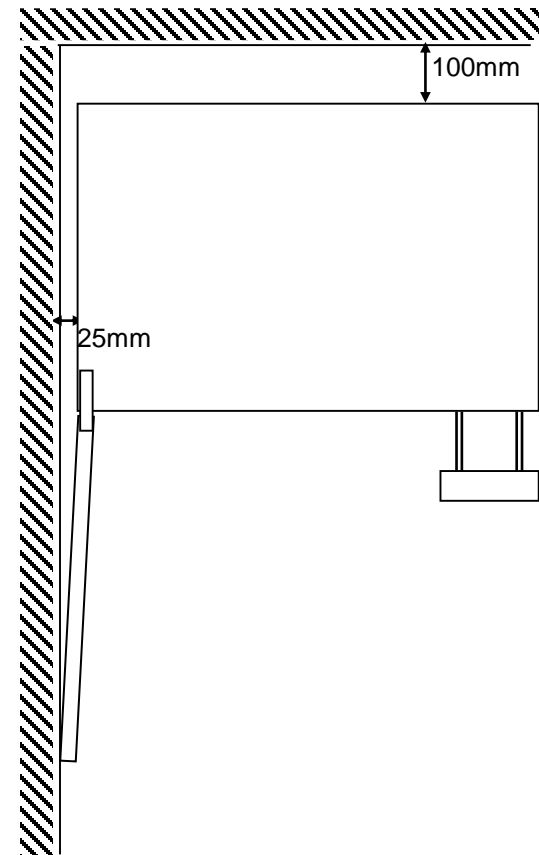

Installation

Electrical Supply Check



CAUTION: It is important that this machine is hooked up to the proper voltage and polarity for your country. Use a Voltmeter to verify voltage and polarity. Should the reading be any different than a normal reading or if you are unsure of what the reading should be, contact an electrician.

• Power Requirements

- The merchandiser is supplied with a service cord for the country of use, and is terminated in a grounding type. The wall receptacle used for this merchandiser must be properly polarized, grounded and of the correct voltage. Operating the merchandiser from a source of low voltage will void the warranty. Each machine should have it's own circuit, and that circuit should be protected with a circuit breaker or fuse to conform to local regulations.
 1. **Voltage Check** - Place the leads of the voltmeter across the Line and Neutral sockets of the wall receptacle. The voltmeter should indicate a stable voltage in a range of 110 to 130Vac for 120V 60Hz locations, or 220 to 240Vac for 230V 50Hz locations.
 2. **Polarity Check** - Place the leads of the voltmeter across the Line and Ground sockets of the wall receptacle. The voltmeter should indicate a stable voltage in a range of 110 to 130Vac for 120V 60Hz locations, or 220 to 240Vac for 230V 50Hz locations.
 3. **Noise Potential Check** - Place the leads of the voltmeter across the Neutral and Ground sockets of the wall receptacle. The voltmeter should indicate zero voltage. A measurement greater than 1.5V could result in operational issues for the merchandiser's electronics caused by electrical noise.

Note: Any deviation from these requirements could result in unreliable performance from your merchandiser.



CAUTION: This procedures requires the use of tools, and should only be completed by a trained technician or operator.

Initial Setup

Key Steps

- After unpacking and installing the machine on location the Key steps to setting up the machine the first time are:
 1. Load a change fund into the coin mechanism.
 2. Set the selection prices in the machine.
 3. Test vend at least one selection on each shelf to verify:
 - a. Pricing is correct, and coin mech, bill acceptor and credit card device are working correctly.
 - b. Product and nutrition information are correct.
 - c. Selection delivers products.
 - d. Delivery bin delivers product to customer.

Filling the Machine

Loading the Machine

- 1) Lift the front edge of the shelf and pull the shelf forward until it stops
- 2) Insert products into spirals
- 3) Once the shelf is loaded, push the shelf back into the machine until you feel front edge raise up over the ramp.

Note: If tall product hits the shelf above when restoring the shelf to the normal vend position, raise the upper shelf to provide clearance

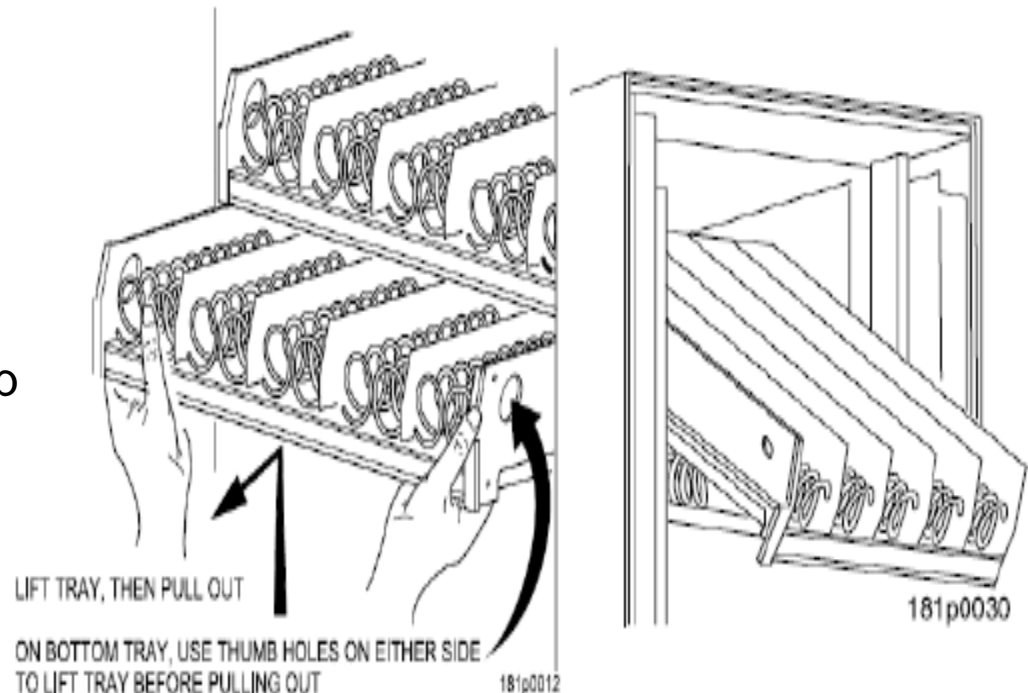

Daily Cleaning

Daily Cleaning

Before leaving the machine each visit, the machine should be inspected and cleaned as follows:

- ① Glass – inside and out – use glass cleaner and disposable towels
- ② Front of monetary panel – do not use ammonia based cleaners as it may cause premature crazing of the polycarbonate surface. We recommend the use of Novus #1 plastic cleaner & polish.

For units equipped with a touch screen, never spray any cleaner directly on the touchscreen, nor permit liquids to flow onto the screen. Apply cleaner to a disposable towel and then apply to the pill or touchscreen. Treat the touchscreen as you would any sensitive electronic device and never use abrasive cleaning materials.

- ③ Delivery Bin – Inside and out – clean any spills or residue with a mild soap and water solution, and wipe dry.



Preventative Maintenance

Cashless Devices

- If your machine is equipped with a cashless device, whether it is a credit card reader, or a proprietary closed system pre-paid card, the magnetic head used to read the payment cards needs to be cleaned regularly to insure proper operation.
- The defined tool for cleaning a magnetic head is a pre-saturated cleaning card, which are commercially available from various sources.
- Based on credit card industry standards, the busier a machine is, the more frequently the magnetic head should be cleaned
- For cashless uses more than 100 times per day – clean it every day
- For cashless uses between 50 and 100 times per day – clean it every other day
- For cashless uses between 10 and 50 times per day – clean it one time per week.
- Actual conditions may vary, and be affected by site conditions, for example a machine located outdoors should be cleaned more frequently.
- Follow the instructions provided with the cleaning card, and slide it past the magnetic head as directed.



Payment Systems

Media2 Merchandisers are capable of accepting multiple forms of payment systems using a Multi Drop Buss or Executive (export only) interface.

- All payment devices are mounted on the slide out assembly. The front of this slide out assembly is called a Pill. There are multiple configurations of the Pill available should you need to add or take away payment peripherals in the future.
- If your payment peripherals were installed at the factory they should already be enabled in the electronics. Currently we enable only \$1 and \$5 bills (notes) in manufacturing. Instructions from the manufacturer for all peripherals installed at the factory are included in the bag assembly in the machine. Please refer to these instructions for information on filling coin tubes, adding bills to recyclers or other pertinent information.
- If your payment peripherals were not installed in manufacturing, please refer to the instructions that came with payment system for set up and installation.
- See the service modes section of this document for information on enabling or disabling different bills and/or additional peripherals.

Turn on the power switch located on front of the power box accessible by pulling out the swing panel.



Power Switch

The Media Merchandisers run on the Linux operating system, it is essentially a computer so it will take a minute to power up just like your computer at home.

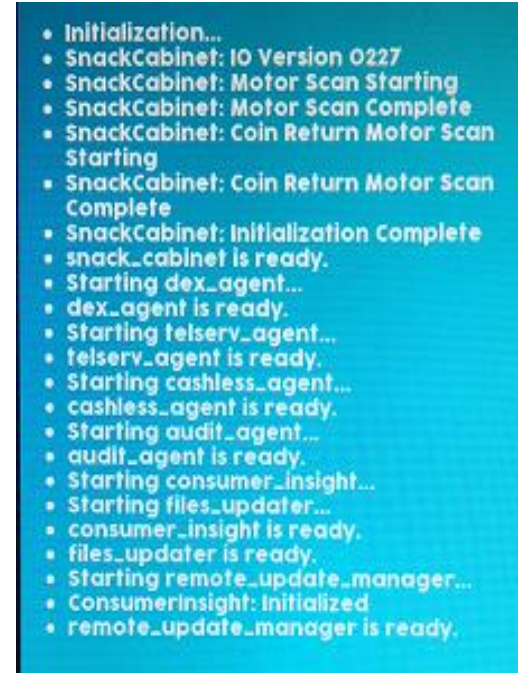

What is Media2

- MEDIA2 is the most advanced electronics platform and shopping experience ever created by Crane; designed to attract more consumers, and take same-store sales to a whole new level.
- New level of consumer attraction and engagement to increase same store sales.
- The new user interface is designed to influence consumer behavior with suggestive selling through a patent-pending recommendation engine... Operators can specify the suggested products, or let MEDIA2 do it for them through different algorithms, like new products, low movers, complementary products or just random selections.
- Takes digital advertising to a new level with full motion video enhanced by Crane Media Net's sponsored advertising campaigns.
- Remote management of Crane Media features including: Price Change, Planograms, Advertising, and Firmware
- Crane's Intelligent Store Remote Services Suite is also available with MEDIA2. It allows operators manage their machines remotely, keeping content fresh and relevant for customers.
- All MEDIA products come with fully integrated payment systems (optional), accepting credit cards, mobile payments, campus cards, and loyalty pay – everything in your customer's wallet which makes purchasing products easy and convenient.

Merchant Media2 Touch screen– Features, Continued

- **Benefits:**
- Attract more consumers with larger touch screen option and rich animated shopping experience
- Convert traffic to sales by influencing consumers purchase decisions
- Increase sales by ALWAYS suggesting more products
- Deliver 41% higher same-store sales vs. non-MEDIA Retrofit Cashless
- Create additional revenue with new digital video advertising
- Decrease service costs with Remote Management (Price Change, Planograms, Advertising, Firmware)

Merchant Media2 Touch screen– Features, Continued

Key Features:

- 7” or 9” Touch Screen Option
- New and Improved Consumer Shopping Experience
- Full Motion Video Advertising
- Featured Products for Undecided Consumers
- Enhanced Shopping Cart with Suggestions
- More areas to Advertise
- Remote Machine Management
- Improved Serviceability and Quicker Boot Times

- This Programming Guide is based on Firmware version 11.0.24
- The software version is shown on the bottom of the screen anytime you are in the Service mode. The software version can also be displayed by pressing the Firmware Information menu bar in the service mode.
- Earlier or later versions of software may not contain all the same menus and/or options. Some Menu items may also be in different places within the menus and may program differently.
- This programming guide is specific about what icons or menu bars to touch within the Modes. When certain Menu items are enabled and disabled additional menu items may appear or disappear. Most of the time this guide will be correct but rely on the display for the correct icons or menu bars to touch.

Below is a list of Menus that should be set up or checked before operating the Machine:

1. When opening the service door on the machine you will be prompted for a PIN, enter 3333 on the touchpad.
2. Set the Prices by selecting button Price Menu Bar in the service mode.
3. Make sure the Shopping Cart Size (max 3) and Shopping Cart Max Value is set to three times the highest price in Product Configuration. Touch: Product Configuration > Shopping Cart Setup.
4. If you have added, moved or removed any motors touch: Product Configuration > Selection Configuration > Perform Auto Configuration.
5. If any motors are being coupled on the candy tray or squat tray, Touch: Product Configuration>Couple Motors.
6. Verify your Coin Mechanism, Bill Validator and Card Reader are enabled in the Monetary Menu.
7. Verify the bills you want to accept are enabled in the Monetary Menu > Bill (Note) Acceptance.
8. Set the Time and Date in the System Setting Menu > Set Time and Date.

If your machine contains a refrigeration unit you must also verify/set the following:

1. Verify or set the Machine Configuration, go to System Settings > The top menu is the current machine configuration.
2. To change the Configuration type touch the Machine Configuration menu bar, your options are Ambient, Refrigerated, European Control, Non-perishable and Chilled. Do not choose European Control unless your area is within the region covered by these requirements.
3. Press Accept to save your choice.
4. Next select Refrigeration Settings, this menu does not appear if the machine is set to Ambient.
5. Touch Adjust Temperature if required and press Accept to lock in any changes or Cancel to exit without making changes.
6. If set to Refrigerated or European Control, Touch Health Control to assign the selections to work with Health Control. The health control menu will not appear if you machine is set to anything other than Refrigerated.
7. If Refrigerated or European Control is selected, all selections in the machine are enabled for Health Control. If you are not using perishable products in all selections, non-perishable products should have the Health Code disabled.

Quick Start Tips – Loading the Coin Mechanism

Prior to placing the machine in service, you must add an initial amount of change to the coin mechanism to prevent a “Use Correct Change” condition. Initial loading of coins should be done through the menu provided to insure the coin mech accurately counts all change available for payback to the customer. *Recommended minimum amount is \$17.00 (1 roll each of 5¢, 10¢, 25¢ coins).* This minimum amount of change should remain in the machine at all times.

Adding Initial Change Load

1. Enter the required PIN: 3333,
2. Touch the Monetary menu bar on the screen.
3. Touch the Coins In/Out menu Bar
4. Increase the amount of Change Available by inserting coins to thru the chute on the top of the coin mech. Totals (count and value) for each coin should increase as coins are added.
5. Press the left arrow to exit and return to the main menu.

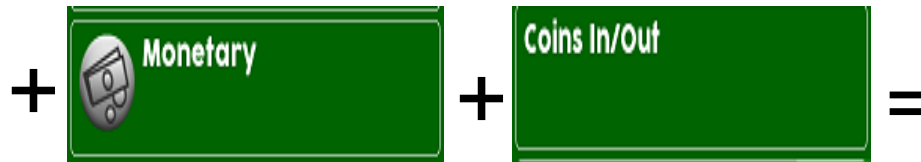

Coins In/Out	
tube #1 (0.05)	63
tube #2 (0.10)	92
tube #3 (1.00)	113

The Touch Screen

- Offers the latest capacitive touch screen technology providing scratch resistance, high durability and a rich consumer experience.
- Is an industrial screen that can withstand medium hard hits w/ hammer similar to gorilla glass used in mobile phones
- Has full motion video Capability
- Self Calibrating
- Provides instructions and information required by the customer to make a purchase.
- Is utilized in the service mode to set up the machine.





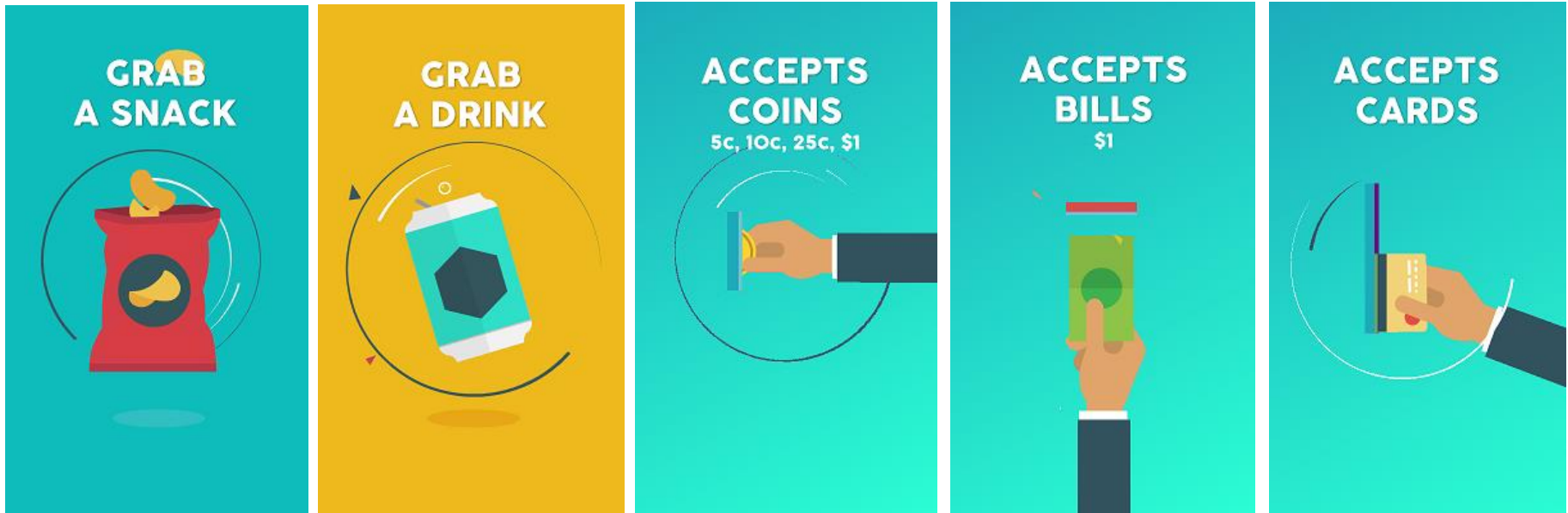



When the machine is not being used, the Touch Screen is showing the Idle loop. The Idle Loop screens will vary depending on what peripherals you have installed and the promotions that are enabled. To enable or disable specific Idle Screens and credit card logos, see System Settings > Advertisements. Touching any of these screens will take you to the Main Menu.



The Selection Process

The Main Menu

Main Menu Screen Features

- The Main Menu allows your customer to view promotions when enabled and view nutritional facts when a Product Library or Planogram is present by pressing 
- If multiple Languages are enabled a change Language icon will be shown on the top of the section screen. 
- On the bottom right corner of the screen there is a Handicap Icon. Pressing this Icon will move the selection keypad down the the bottom of the screen meeting the wheelchair accessibility requirements. 
- There is an X icon on the top right corner allowing you to cancel a transaction. 
- The bottom of the screen will show both the Credit and Cash Price. 
- When entering a selection there is a backspace key that allows you to delete one character at a time if a mistake is made entering a selection number. 

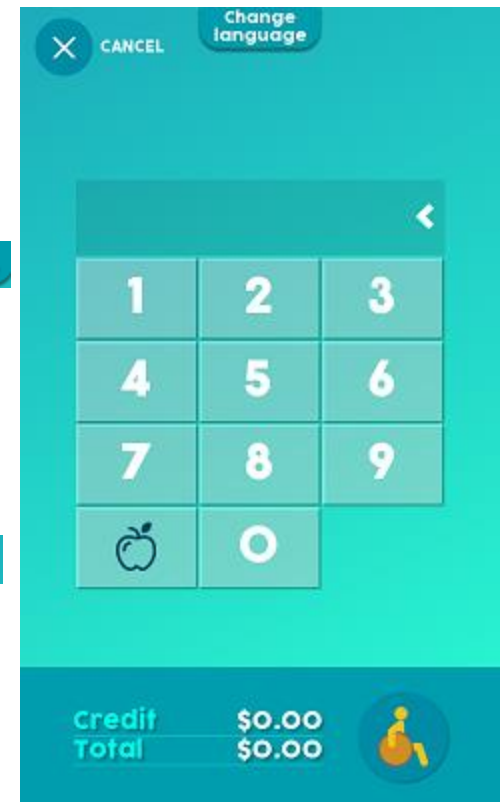

The Selection Process

Making Selections and Navigating the Shopping Cart

Use the Keypad to make a selection. Your selection will be placed in a shopping cart. The Media 2 will suggest another product (programmable if desired) allowing you to select the + key to add that selection. Choose Keep Shopping to add additional selections (maximum 3) to your cart. Press Check Out when finished.

Note: The shopping cart can be disabled by enabling Rapid Vend under the Special Vend Modes menu and the machine will immediately go to checkout after making a selection.

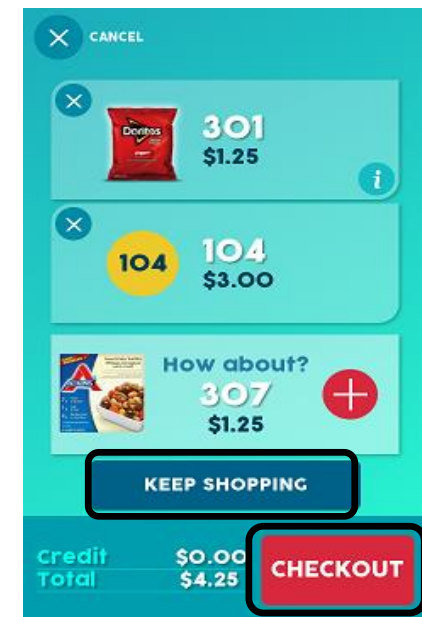
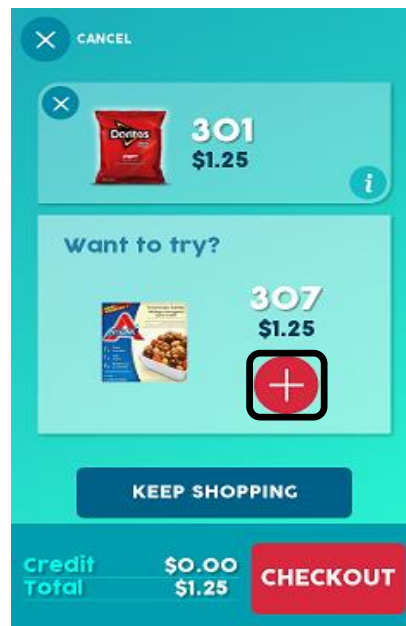

The Selection Process

Making Selections and Navigating the Shopping Cart

If you have a UPC code associated with that selection an image of the product will appear on the screen

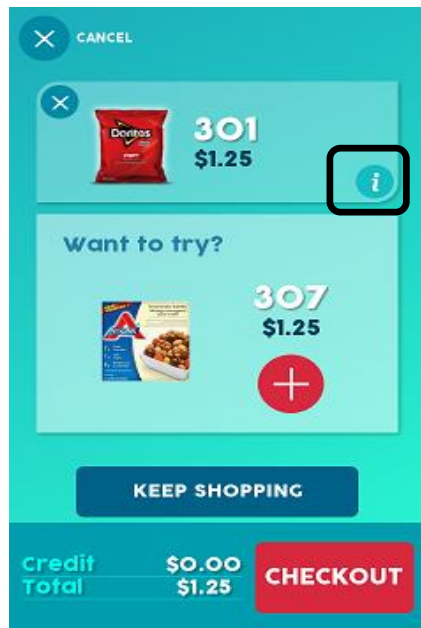

Pressing the information Icon next to the product image will show a popup with nutritional information for that product



The Selection Process

Making Selections and Navigating the Shopping Cart

If you do not have a planogram installed, or a UPC code assigned, an image of a generic product will appear on the screen

To remove a product from the shopping cart press the X as shown below.

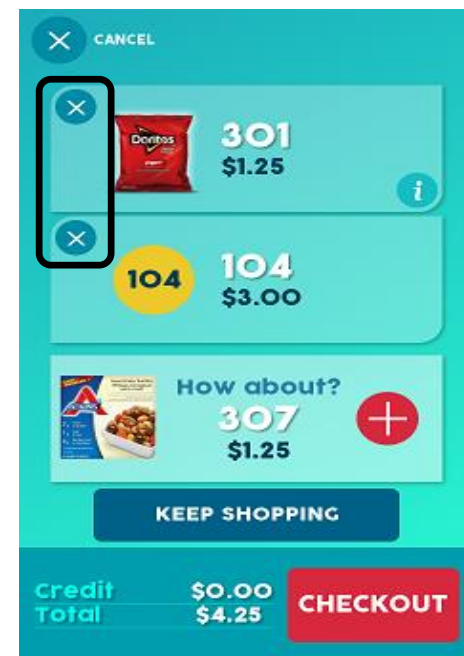
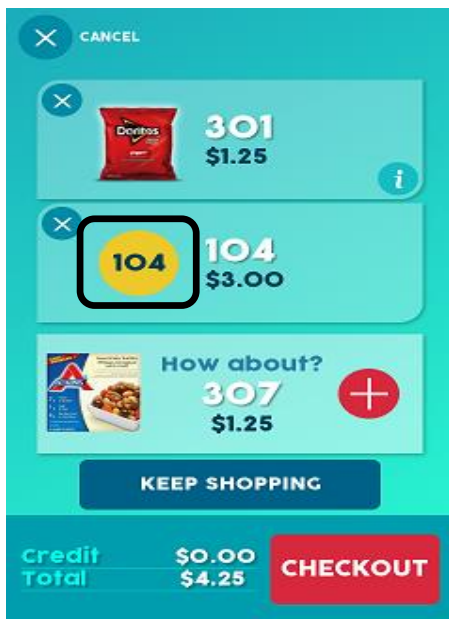

The Selection Process

Making Selections and Navigating the Shopping Cart

Any Discounts or Surcharges will be shown to the top right of the shopping cart as well as the total of all products in the cart.

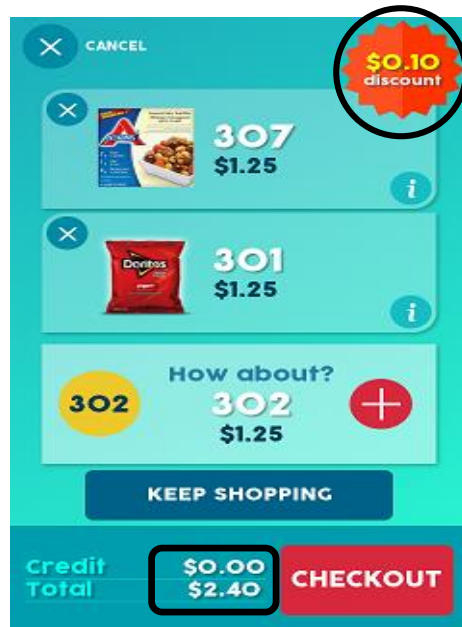

At any time you can press the cancel icon to cancel the entire sale. If nothing happens for 30 seconds (settable) the machine will cancel the transaction and return to the idle screen.

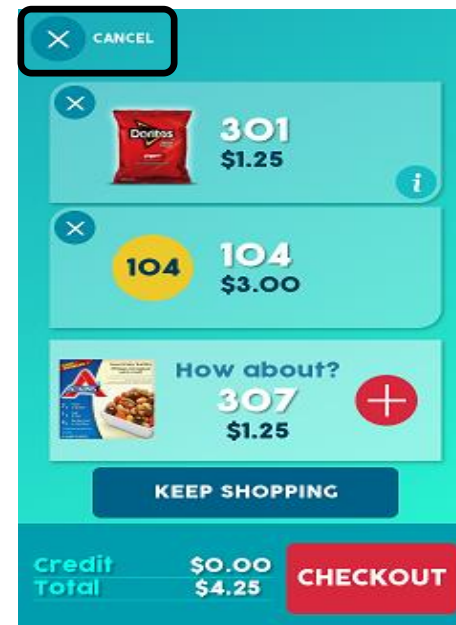

The Selection Process

Making Selections and Navigating the Shopping Cart



Any type of payment, cards, coin or bills can be inserted any time during the transaction. Pressing checkout will cause the settlement screen to appear if money has not already been inserted

The settlement screen(s) will communicate to the customer their payment options



Accessing the Service Modes

When the monetary compartment is opened, the display will prompt the operator to enter a PIN number on the Touch Screen to gain access to the service modes.

- The default PIN for route driver access is **1111** (limited access).
- The default PIN for programming access is **3333**.
- If errors exist, an  will appear on the bottom right corner of the screen. Pressing the  allows the user to view the existing errors without entering one of the pin number above.

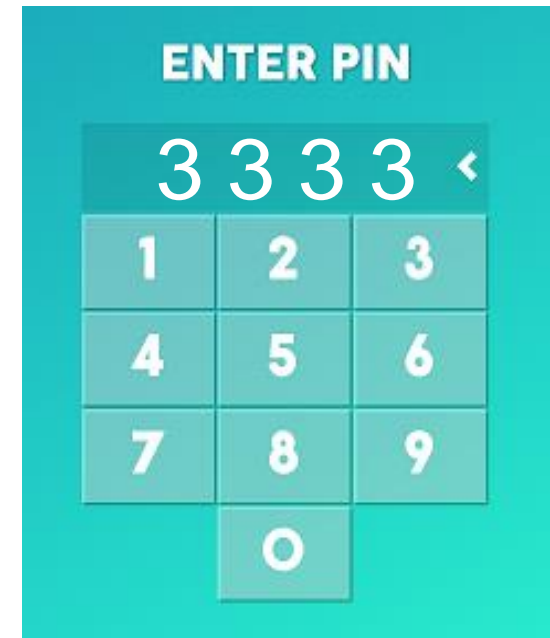

- If **Active Errors Exist**, an error list will be shown on the display that includes the time and date of each error.
- The errors do not need to be cleared, once corrected the error will be erased automatically.
- To escape to Error list press the Back or Home Icon
- The reason for last reboot and the uptime since last reboot are also shown for informational and troubleshooting purposes.

The screenshot shows a green-themed interface with a navigation bar at the top containing 'Back', 'Home', and 'Test' buttons. Below the navigation bar is the title 'Diagnostics' and the section 'Active Errors'. A table lists an error event with its ID, time, and date. Below the table are two sections: 'Last Reboot Reason' with a 'Request' button, and 'Uptime Since Last Reboot' showing a duration of 1 hour and 4 minutes.

Event ID	time	date
SV NF Comm Error	16:47	06/15/2018

Last Reboot Reason
Request

Uptime Since Last Reboot
1 hours 4 minutes

If PIN **1111** was entered and **No Errors Exist**, the home screen for the Driver menu will appear. This menu allows limited access to the service modes. Touching an icon or Menu bar on the screen will provide access to that menu.

Driver access allows you to:

- Data Recall - View sales data.
- Home all Un-homed Motors.
- Planogram - Manage or Audit the existing.
- View the Firmware information
- Telemetry - Send a wireless DEX read.
- Diagnostics Menu – View existing errors

For access to all other service modes use PIN # 3333



The **Data Recall, Firmware Information and Telemetry Menus** are duplicated in the service Menu. See the Service Menu for detailed descriptions of these menus.

Planogram and Home Un-homed Motors

Although there are ways to manage the Planogram and Home Un-homed Motors in the Service Menu, in the Driver Menu there are specific icons that allow quick access to these menus.

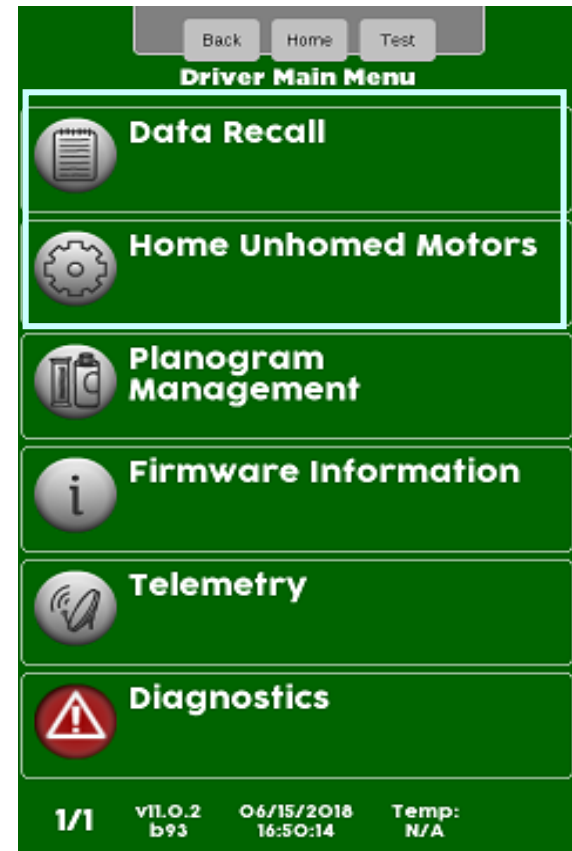



Driver Menu Access Planogram Management

- The Planogram Management Icon allows you to assign the UPC code on the product package to a selection.
- Once a UPC code is assigned to a selection the consumer will see an image of that product when that selection is made.
- Pressing the information Icon next to the product image will show the nutritional information for that product.
- For a UPC code to be valid, The UPC Code must be in the Library or Planogram loaded in the machine.
- Deleting a UPC Code will cause that selection to show a generic picture on the display and information icon will not be shown.
- You can use the same UPC Code for multiple selections if you have two or more selections of the same product.
- Cashless customers can create and push planograms over the air or a planogram can be loaded onto a USB and uploaded into the machine.

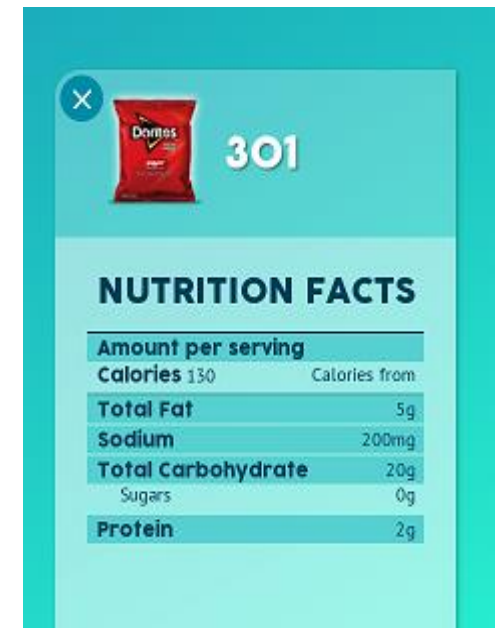



Driver Menu Access

Planogram Management

Touch Planogram Management to enter the Planogram Menu

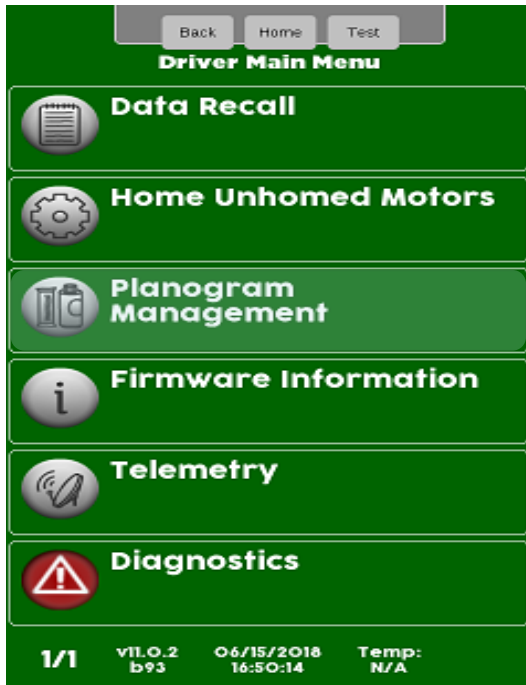

Touch a menu bar to View, Audit or Edit the Planogram

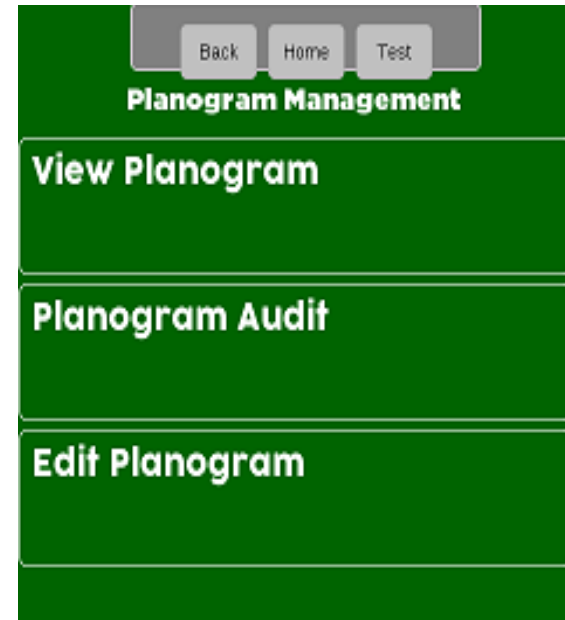



Driver Menu Access

Planogram Management – View Planogram

Touch View Planogram to View the current Planogram information

If a Planogram has been loaded into the machine, an image, price and selection number for each selection will be shown. If not a generic picture will be shown.

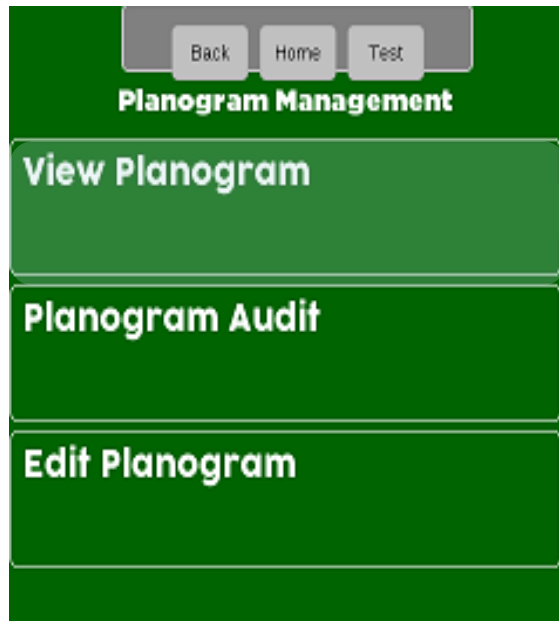



Driver Menu Access

Planogram Management – Audit Planogram

Touch Planogram Audit to enter the Planogram Menu



Choose a Tray you wish to Audit



The screen will show the current Product & UPC assigned to the selections on that tray.

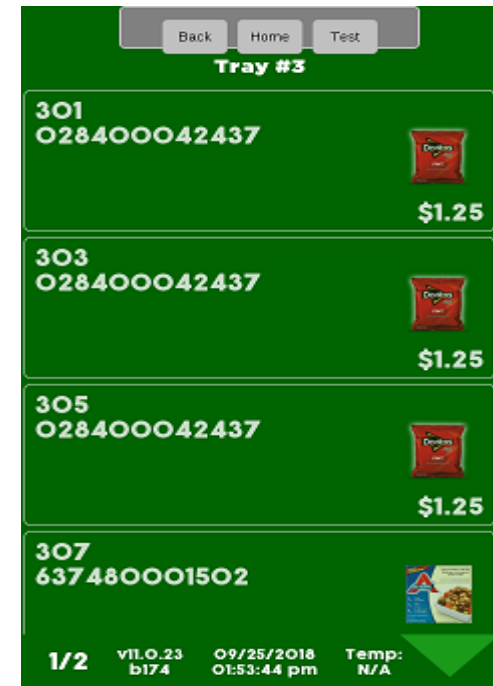



Driver Menu Access

Planogram Management – Edit Planogram

Touch Edit Planogram to make changes to the Planogram Menu

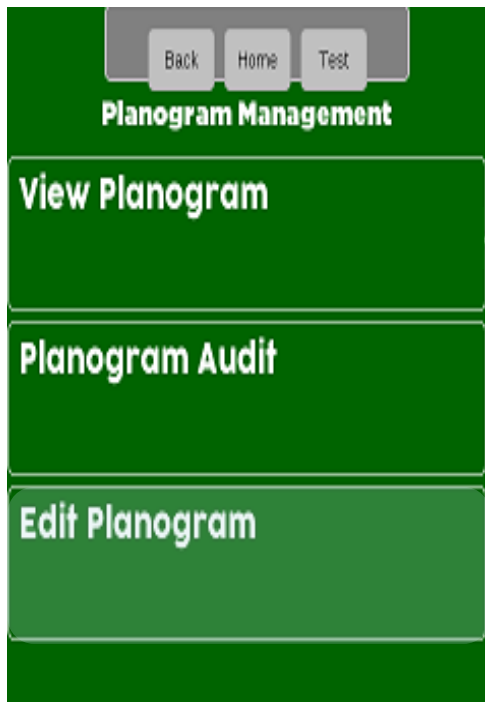

Choose a tray you wish to Edit



Choose the selection you wish to Edit





Driver Menu Access

Planogram Management - Edit Planogram

Touch Product to enter a new UPC code.

A screenshot of the Planogram Management interface. At the top, there are three buttons: "Back", "Home", and "Test". Below them is the number "301". The main area is a green form with three sections: "Product" with the value "028400042437", "Price" with the value "\$1.25", and "Save".

Touch Product to enter a new UPC code or select product from a list

A screenshot of the Planogram Management interface. At the top, there are three buttons: "Back", "Home", and "Test". Below them is the number "301". The main area is a green form with two sections: "Select From The Product List" and "Edit Current Code" with the value "028400042437".

If you choose Select From The Product List all products will be listed and you can scroll through to choose a product. If you choose Edit Current Code a numeric box will appear allowing you to enter a new UPC code. This code must be in the current Planogram or Library. You must choose Save to lock in the changes



Driver Menu Access

Planogram Management - Edit Planogram

Touch Price to enter a new price for the selection

A numeric keypad will appear, enter a new price and choose accept.

The screen will revert back to the previous menu, you must choose Save to lock in the changes.

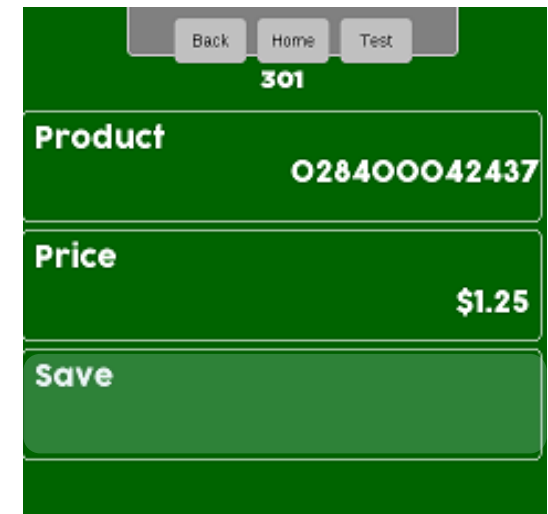
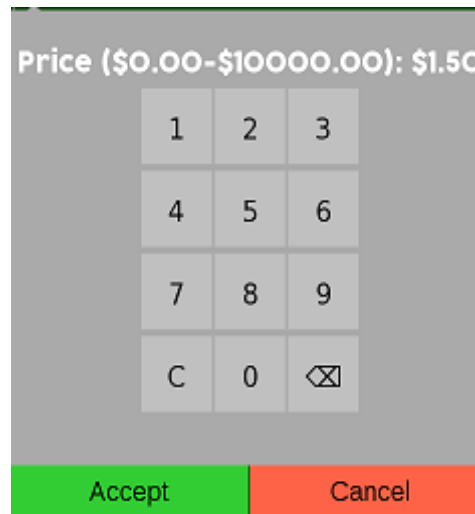
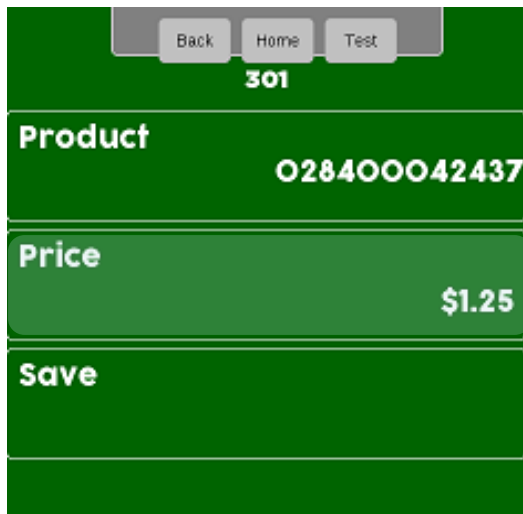

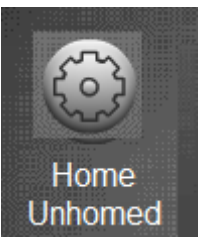

Driver Menu Access

Home Un-Homed Motors

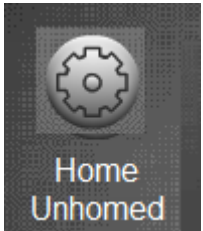

Pressing the Home Un-homed icon will home any motors that are not in the home position. Typically this would be pushed before servicing the machine because any motors that are not at home will most likely drop a product when rotating to the home position.

Most of the time when a motor is not at home, it is because there was an issue with a product dropping and the SureVend feature was activated because a product did not drop, therefore the spiral was advanced until the product dropped. If motors are not homed when servicing the machine and a motor is not in the home position, the next time that selection is attempted the spiral will stop in the home position if a product drops essentially correcting itself.

How Do I Access the Service Modes?

- If PIN **3333** is entered and **No Errors Exist**, the Operators / Technician menu appears allowing access to the service Menu bars.
- Each of the Menu Bars provides access to detailed menus under the corresponding heading.
- Pressing a Menu on the screen provides access to that menu.
- Press the down arrow at the bottom or top of the screens to toggle between the screens shown



How do I use the Touch Screen in the Service Mode?

- For Programming purposes the Merchant Media platform uses a 7" or 9" LCD touch screen and a series of icons and Menu Bars to provide access to the Service Modes.
- Touching a Menu Bar will take you to that Menu followed by a list of related sub menus.
- A successful touch of an icon or Menu Bar will sound an audible beep to acknowledge acceptance of the touch on the screen before proceeding to the selected menu.
- The lighter green arrow at the top or bottom of the screen indicates that additional menus are available to be seen or reviewed.

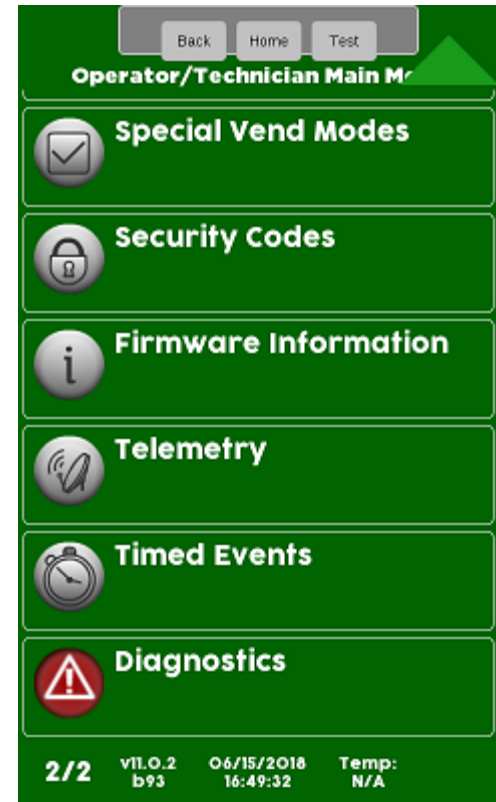

Main Menu

- Across the top of the Main Service Menu is a series of three icons that will always be present when in the service menu.
 - The back icon returns you to the prior menu
 - The Home icon returns you to the Main Service Menu
 - The Test icon is not currently used.
- The content of the Main Menu area will change depending what menu you are in.

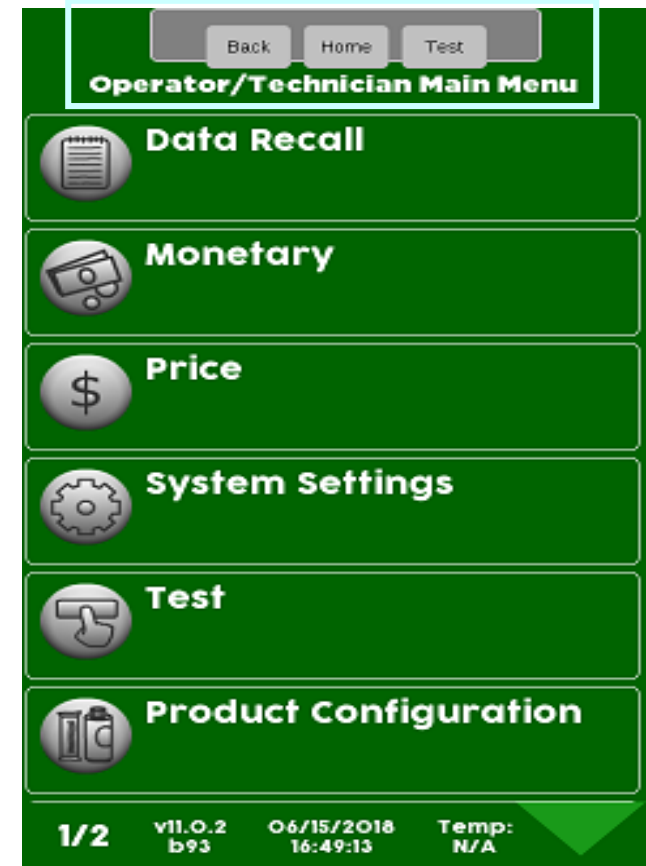

How do I use the TouchScreen in the Service Mode?

- All the features normally associated with a touch screen, its icons and menu bars are possible, including:
 - Touching an icon or menu bar to toggle it's current state (On to Off, Yes to No, etc), or
 - Touching a menu item to access another level of the tiered menu system.
 - Alpha & numeric keypads will pop up when required for input.
 - Confirmation boxes will appear to confirm an item to be added or deleted.
- Another feature of this screen is that it shows the current time, date, temperature and current Atlas LE board software revision at the bottom of the screen.

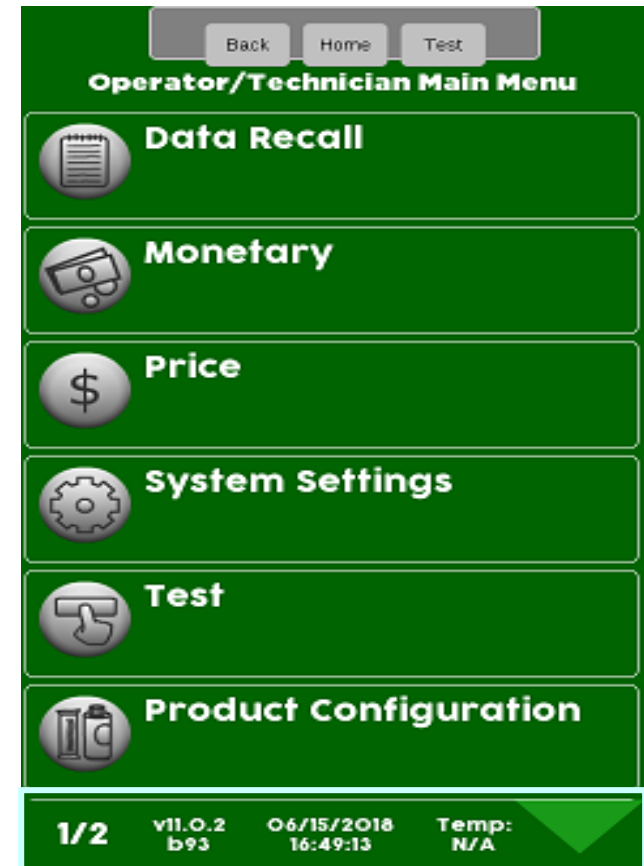

Menu Chart

MEDIA2 Service Mode Menu Chart

Menus 1 to 6

Data Recall

- Non Resettable Sales Data
- Resettable Sales Data
- Events
- Identification Numbers
- SureVend™ Corrected

Monetary

- Bill Validator
- Coin Mechanism
- Card Reader A
- Card Reader B
- Onboard Cashless Enable
- MSB Cashless Cart
- MDB Cashless Post Pay
- Show Currency Symbol
- Correct Chang Parms
- Cash Discount

Price

- Entire Machine
- Tray 1
- Tray 2
- Duplicates for all Trays
- Individual Prices

System Settings

- Machine Configuration
- Refrigeration Settings
- UI Theme
- Machine Information
- Time and Date
- Language
- Custom Messages
- Idle Timeout
- Screen Renewal
- Software Updates
- Backup / Restore
- Clone Configurations
- Clone Board
- Cab Lights - Out of Service
- Advertisements
- Led Color
- Data Transfer Standard
- Screen Brightness
- Automatic Reboot Settings

Test

- Screen Test
- Touchscreen Test
- Refrigeration Test
- Surround Lighting Test
- Motor Test Summary
- SureVend™ Calibration
- Detailed Motor Test
- Cabinet Lighting Test
- Coin Return Motor
- Test Vend
- NFC/Mag Head Test

Product Configuration

- Update Planogram
- SureVend™
- Couple Motors
- Selection Configuration
- Remove Product Library
- UPC/EAN Codes
- Shopping Cart Setup
- Space to Sales
- View Planogram
- Browse Categories

Back
Home
Test

Operator/Technician Main Menu

 **Data Recall**

 **Monetary**

 **Price**

 **System Settings**

 **Test**

 **Product Configuration**

1/2
v11.0.2
b93
06/15/2018
16:49:13
Temp:
N/A

Menu Chart

Service Mode Menu Chart

Menu 7 to 12

Special Vend Modes

- Alternative Vending
- Free Vend
- Token Enabled
- Winner Mode
- Combo Vends
- Rapid Vend
- Skip Main Menu
- MultiVend Discount

Security Codes

- Enter Pin
- Change Driver Pin
- Change Operator Pin
- Change Engineer Pin
- Change Manufacture Pin
- Route Driver Price Menu

Firmware Information

- Kernel Version
- Software Version
- I/O board Version
- MDB Device information
- Assigned Cashless Processor

Telemetry

- Assign Unit
- Send Dex
- Ping Server
- Sync Time with Server
- Get Network Status
- Update Configuration
- Load Network Configuration
- Show Network Configuration
- Un-Assign Unit
- Enable Mesh

Timed Events

- Time of Day Events
- Back Up Events
- Power Saving Events
- Refrigeration Storage
- Suggestion Engine

Diagnostics

Show Errors W Time/Date

The screenshot shows the 'Operator/Technician Main Menu' interface. At the top, there are buttons for 'Back', 'Home', and 'Test'. Below these are five menu items, each with an icon: 'Special Vend Modes' (checkmark), 'Security Codes' (lock), 'Firmware Information' (info), 'Telemetry' (signal), and 'Timed Events' (alarm clock). At the bottom, there is a status bar with '2/2' on the left, and 'VII.O.2 b93', '06/15/2018 16:49:32', and 'Temp: N/A' on the right.

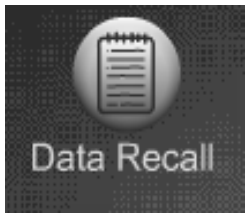

Data Recall Menu

- The Data Recall Menu permits the operator to review a variety of accountability and operational information including:
 - Non Resettable Sales Data
 - Resettable Sales Data
 - Events
 - ID Numbers (boards & peripherals)
 - SureVend Corrected Vends

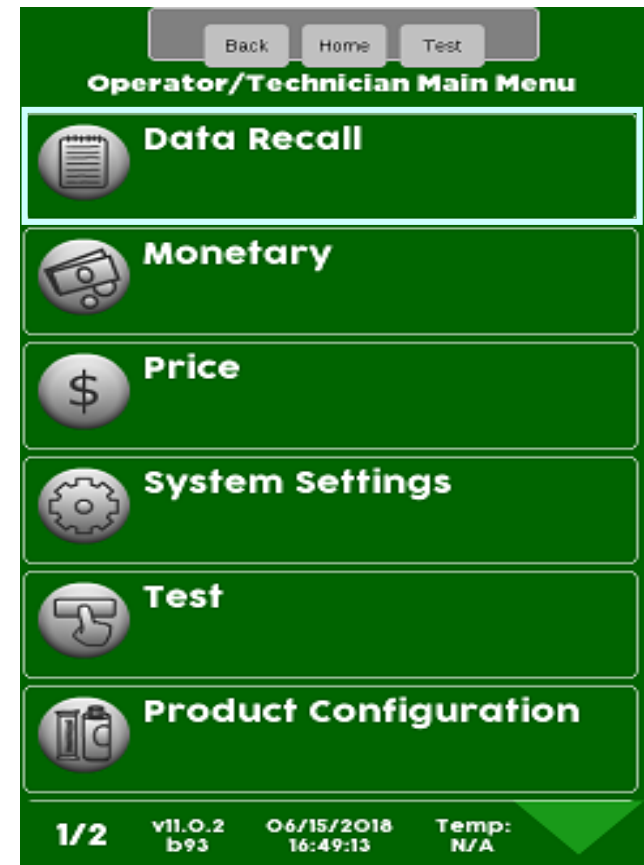

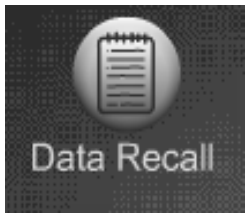

Data Recall Menu

Non Resettable vs Resettable Sales Data

The Non-Resettable and Resettable data screens are exactly the same and therefore not duplicated in this programming guide. There is one additional menu in the Resettable menu, Clear Data. This menu allows you to reset to zero the resettable data. As a default the Resettable Data is also reset each time the machine successfully transmits a DEX file. The Non-Resettable Data can not be reset.

Non Resettable Data

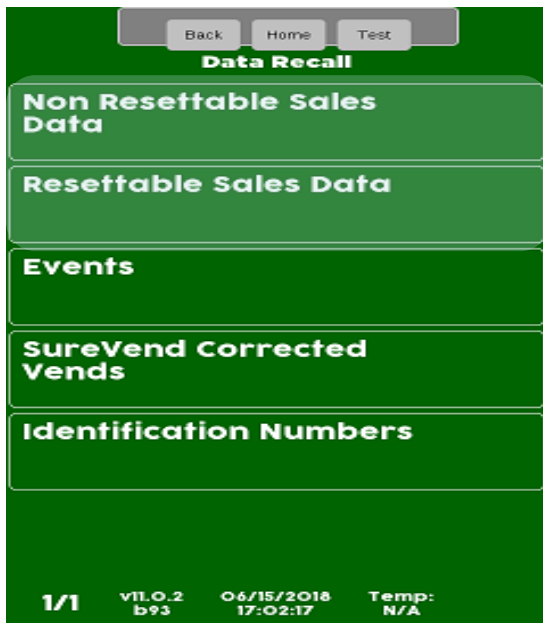

Resettable Data



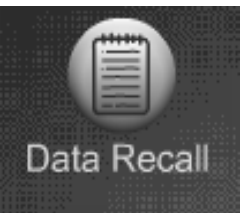

+

Non Resettable Sales Data

or

Resettable Sales Data

Data Recall Menu

Cash Totals

Touch Cash

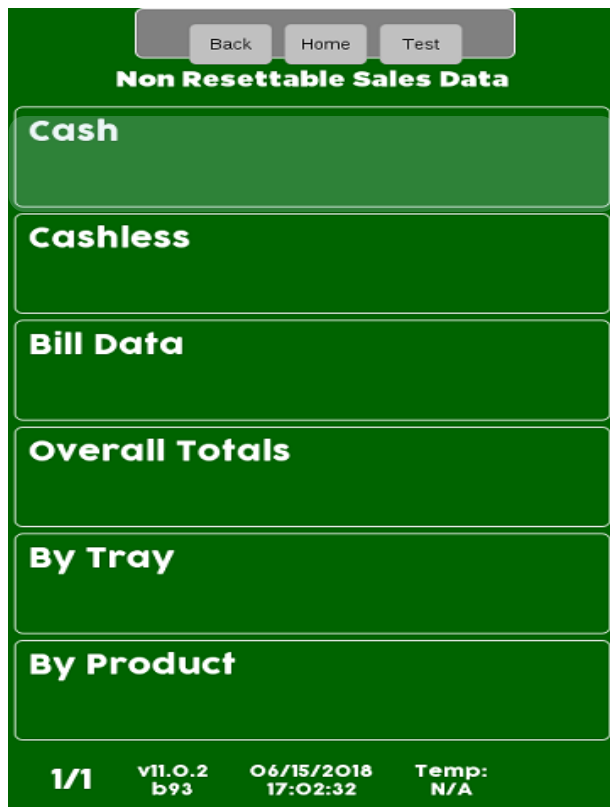

The value and number of cash sales will be shown on the screen below.

Non Resettable Sales Data		
Cash:		
		#
Cash In	\$0.00	—
To Cashbox	\$0.00	—
To Tubes	\$0.00	—
Bills In	\$0.00	—
Dispensed	\$0.00	—
Manual Dispensed	\$0.00	—
Sales	\$0.00	0
Discounts	\$0.00	0
Surcharge	\$0.00	0
Overpay	\$0.00	0

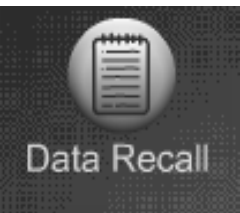

Non Resettable Sales Data



or

Resettable Sales Data

Data Recall Menu Cashless Sales Data

Touch Cashless

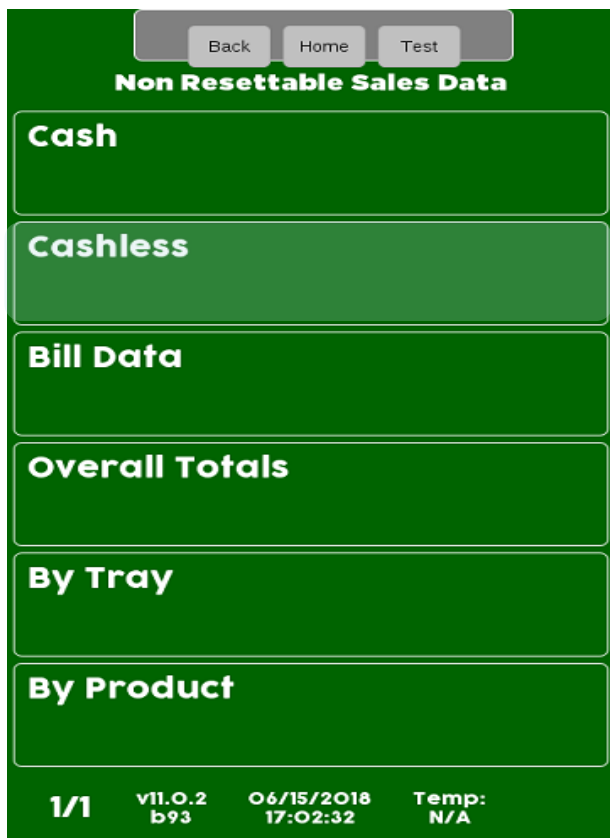

The screen will show the value and number of Cashless Transactions by vend type including Revalue if applicable

Non Resettable Sales Data

Cashless A

		#
Sales	\$0.00	0
Discounts	\$0.00	0
Surcharge	\$0.00	0
Revalue	\$0.00	0

Cashless B

		#
Sales	\$0.00	0
Discounts	\$0.00	0
Surcharge	\$0.00	0
Revalue	\$0.00	0



Non Resettable Sales Data

+

or

Resettable Sales Data

Data Recall Menu

Bills Sales Data

Touch Bill Data

Back Home Test

Non Resettable Sales Data

Cash

Cashless

Bill Data

Overall Totals

By Tray

By Product

1/1 v11.0.2 06/15/2018 Temp:
b93 17:02:32 N/A

This Screen below allows you to view information about bills by denomination, both accepted and paid out when using a validator or recycler. Also included is the current value of bills stored in a recycler cassette if applicable .

Back Home Test

Non Resettable Sales Data

Bill Data

	In	Out
one	0	0
two	0	0
five	0	0
ten	0	0
twenty	0	0
fifty	0	0
hundred	0	0

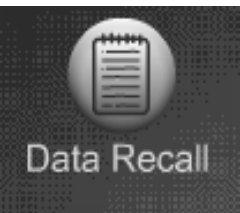

Non Resettable Sales Data

+

or

Resettable Sales Data

Data Recall Menu

Overall Totals

Touch Overall Totals



The screen will show a summary of the Overall Totals, both cash and number of transactions

Category	Amount	Count
Sales	\$0.00	0
Discounts	\$0.00	0
Surcharge	\$0.00	0
Test Vend	\$0.00	0
Free Vend	\$0.00	0
Cash	\$0.00	0
Cashless A	\$0.00	0
Cashless B	\$0.00	0
Mixed Sales	\$0.00	0
Token	\$0.00	0

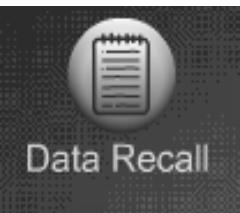

Non Resettable Sales Data

+

or

Resettable Sales Data

Data Recall Menu

Data by Tray

Touch By Tray

Touch a tray number to see the sales data for that tray.

Totals for the tray selected will be shown on the display. Press the Back or Home to exit

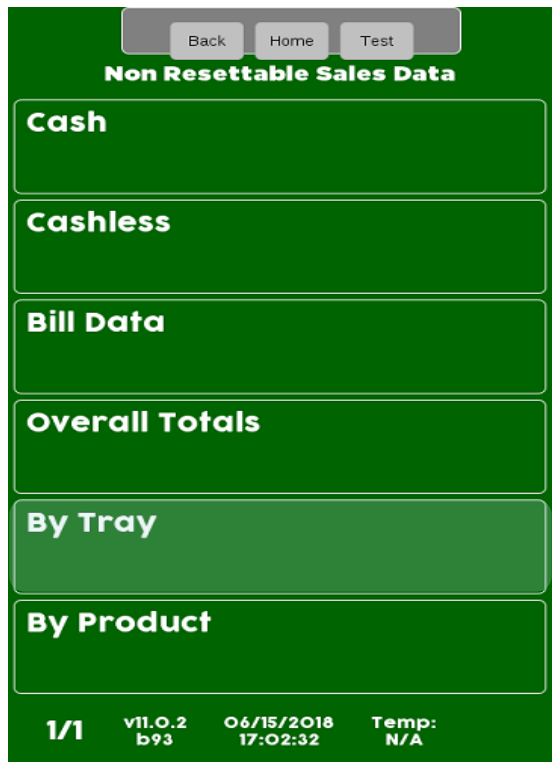

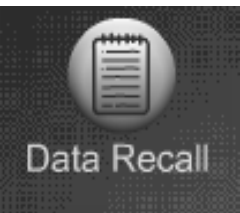

Non Resettable Sales Data

+

or

Resettable Sales Data

Data Recall Menu

Data by Product

Touch By Product to view sales data By Product.

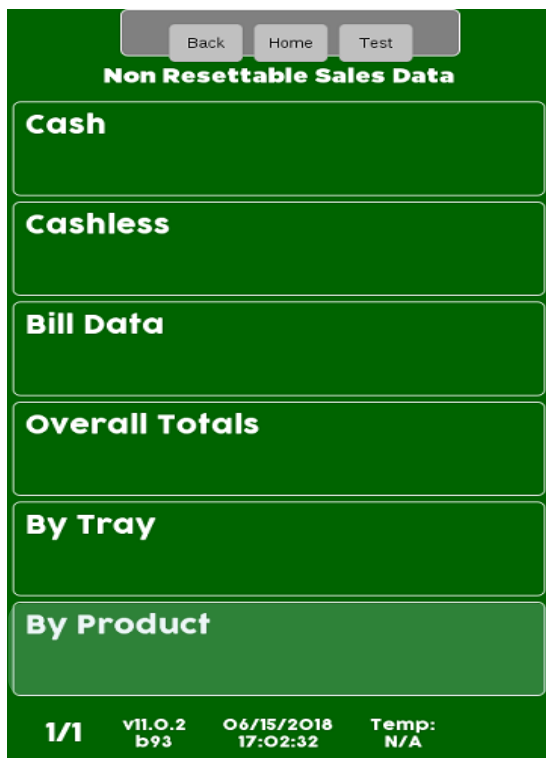

Touch any tray to see the sales data for that tray.





Non Resettable Sales Data

+

or

Resettable Sales Data

Data Recall Menu

Data by Product

Touch a selection number to view Sales Data by Product.

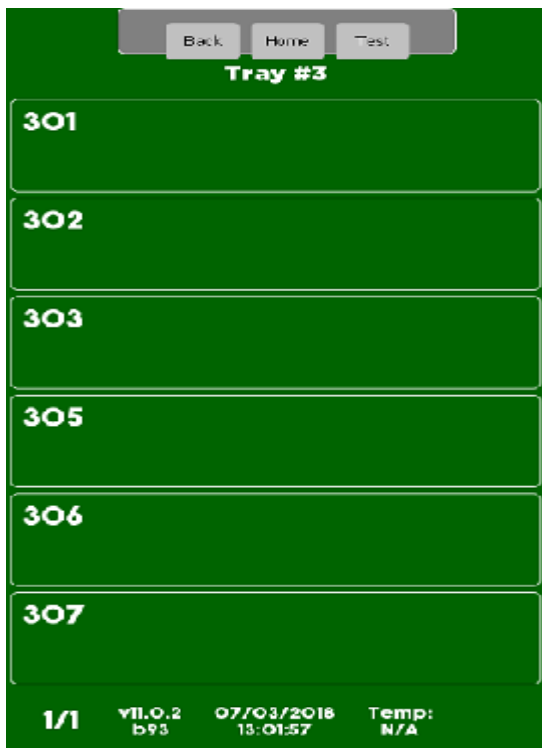

Totals for the selection chosen are shown on the display, Press Back or Home to exit



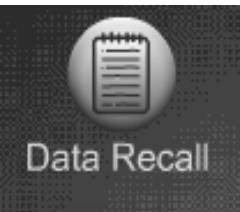

+ Resetable Sales Data

Data Recall Menu

Clear Resetable Data

- There is one additional menu in the Resetable Menu that is not in the Non-Resetable Menu, Clear Data.
- This menu allow you to clear the Resetable Data. The Non-Resetable Data can not be cleared.
- The resetable data is also cleared each time the machine successfully transmits a DEX file.

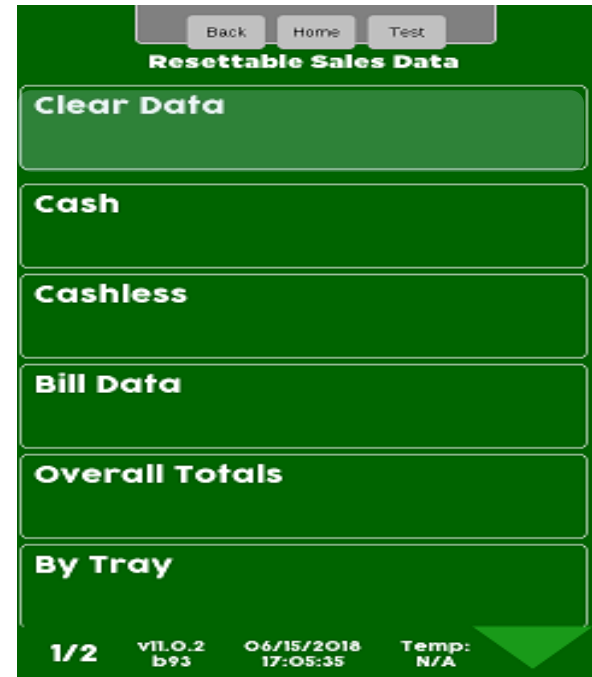



Events

Data Recall Menu

Events

Event History

This menu allows the operator to review the most recent times for the following events:

Touch Reboot History, Power Loss or Door Events History to view a historical list of events.

The following information will show without entering a Menu.

- Last Data Clear
- Last Vend Information
- Last Price Change
- Last Clock Set
- Last Health Control Event (if set to refrigerated).

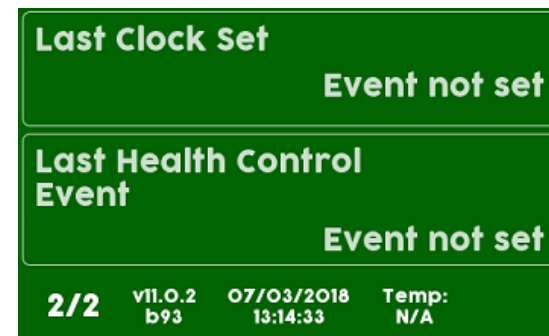
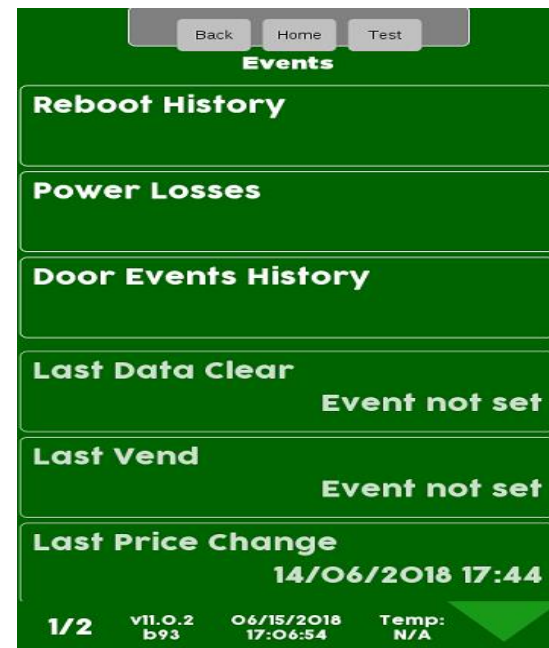

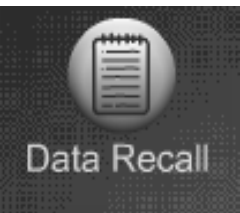

+

Events

Data Recall Menu

Events – Reboot History

Touch Reboot History

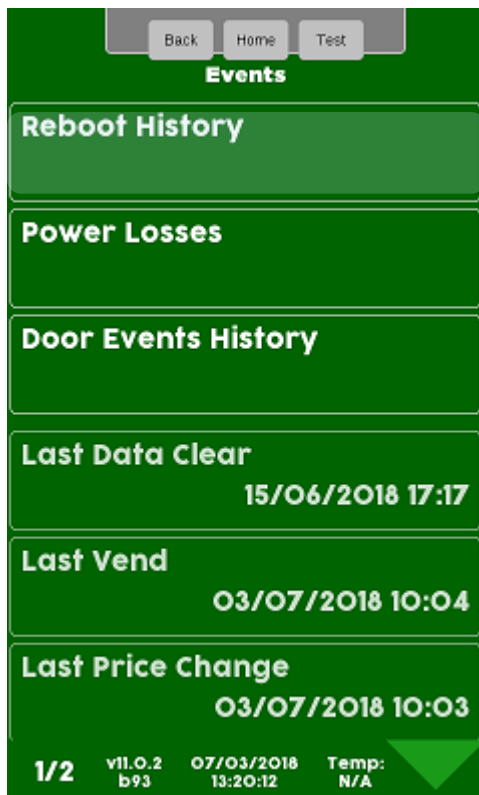

Power Losses are shown on the display including Reason, Time and Date

Back Home Test

Reboot History

Reboot Reason	time	date
Request	14:20	06/13/2018
Request	14:21	06/13/2018
Request	14:22	06/13/2018
Request	14:23	06/13/2018

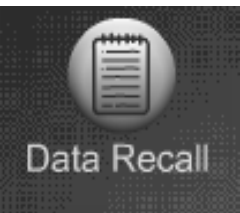

+

Events

Data Recall Menu

Events – Power Losses

Touch Power Loss History

Back Home Test

Events

Reboot History

Power Losses

Door Events History

Last Data Clear
15/06/2018 17:17

Last Vend
03/07/2018 10:04

Last Price Change
03/07/2018 10:03

1/2 v11.0.2 07/03/2018 Temp:
b93 13:20:12 N/A

Power Losses are shown on the display including Duration, Time and Date

Back Home Test

Power Losses

duration	time	date
0 hours 0 minutes	09:44	07/03/2018
13 hours 28 minutes	18:55	07/02/2018
405 hours 37 minutes	17:41	06/15/2018
0 hours 0 minutes	15:44	06/15/2018
14 hours 38 minutes	18:20	06/14/2018
0 hours 1 minutes	18:11	06/14/2018
0 hours 1 minutes	17:59	06/14/2018
0 hours 1 minutes	11:48	06/14/2018
0 hours 0 minutes	11:48	06/14/2018
0 hours 1 minutes	11:45	06/14/2018



+

Events

Data Recall Menu

Events – Door Events

Touch Door Events History

Back Home Test

Events

Reboot History

Power Losses

Door Events History

Last Data Clear
15/06/2018 17:17

Last Vend
03/07/2018 10:04

Last Price Change
03/07/2018 10:03

1/2 vll.o.2 07/03/2018 Temp:
b93 13:20:12 N/A

The Door Events are shown on the display including Duration Time and Date

Back Home Test

Door Events History

duration	time	date
0 hours 16 minutes	12:38	07/03/2018
2 hours 17 minutes	10:20	07/03/2018
0 hours 15 minutes	10:04	07/03/2018
0 hours 0 minutes	10:03	07/03/2018
0 hours 0 minutes	10:02	07/03/2018
0 hours 0 minutes	10:02	07/03/2018
0 hours 0 minutes	10:01	07/03/2018
0 hours 1 minutes	10:00	07/03/2018
0 hours 1 minutes	09:58	07/03/2018
0 hours 0 minutes	09:57	07/03/2018

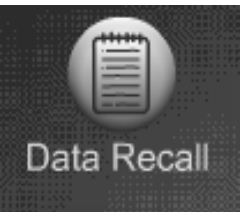

+

Events

Data Recall Menu

Events

The following information will show the Date and Time of the last event without entering a Menu.

- Last Data Clear
- Last Vend Information
- Last Price Change
- Last Clock Set
- Last Health Control Event (if set to refrigerated).



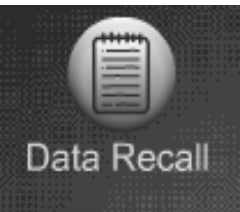

+ SureVend™ Corrected Vends

Data Recall Menu

SureVend™ Corrected

SureVend™ Corrected

This menu allows the operator to review the number of SureVend™ Corrections by:

- Machine/Tray Totals.
- By product.
- The last corrected vend information is viewable without entering the menu.



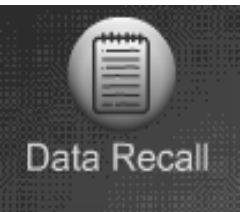

+ SureVend™ Corrected Vends

Data Recall Menu SureVend™ Corrected

Touch SureVend™
Corrected Vends

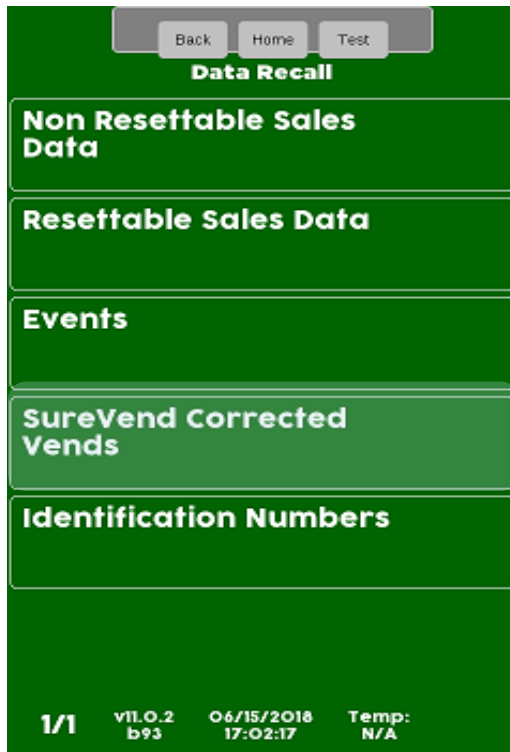

Touch Machine/Tray Totals
to see overall totals



The display will show
resettable & non resettable
SureVend™ corrected totals
by Machine and Tray

	Resettable Sales Data	Non Resettable Sales Data
Total	0	0
Tray #1	0	0
Tray #2	0	0
Tray #3	0	0
Tray #4	0	0
Tray #5	0	0
Tray #6	0	0
Tray #7	0	0



Data Recall

+ SureVend™ Corrected Vends

Data Recall Menu SureVend™ Corrected

Touch By Product to view detailed SureVend™ information by selection.

Touch a tray to view SureVend™ corrected information by selection

The display will show resettable & non resettable SureVend™ corrected totals by Selection number



	Resettable Sales Data	Non Resettable Sales Data
301	0	0
302	0	0
303	0	0
304	0	0
305	0	0
306	0	0
307	0	0
308	0	0
309	0	0
310	0	0
311	0	0
312	0	0



+ Identification Numbers

Data Recall Menu

Identification Numbers

Touch Identification numbers

All Items attached to the controller using MDB communications will be shown. Press Back or Home to exit.

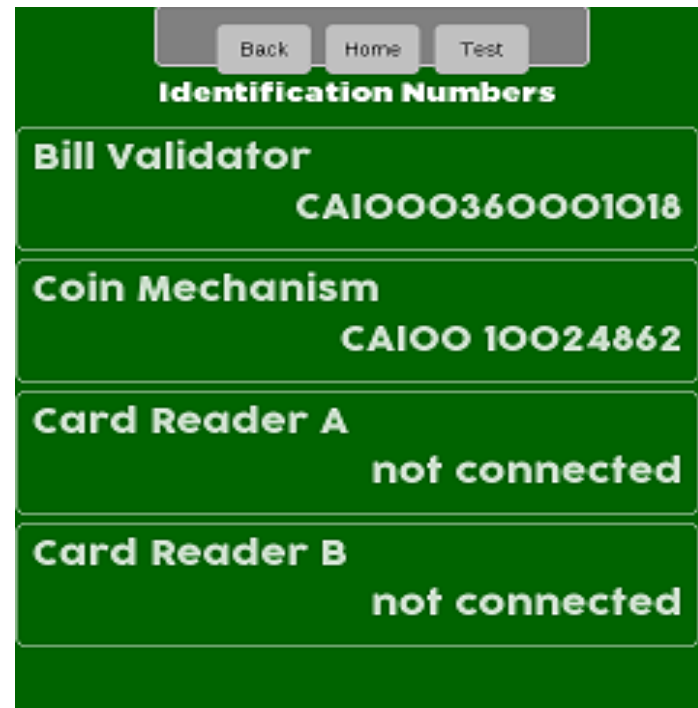
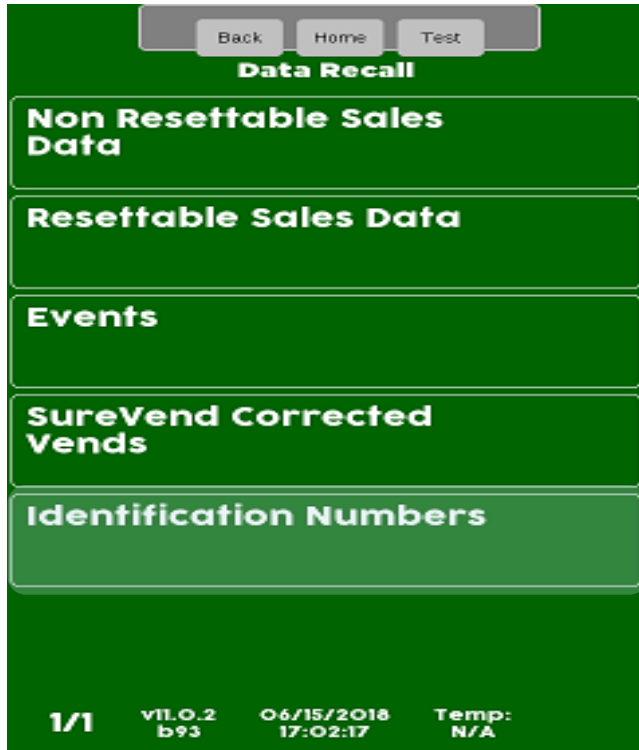



Monetary Menu

Monetary Menu Icon

- Allows you to program the settings for all credit devices and related functions.
- Touch Monetary to enter the Menu.

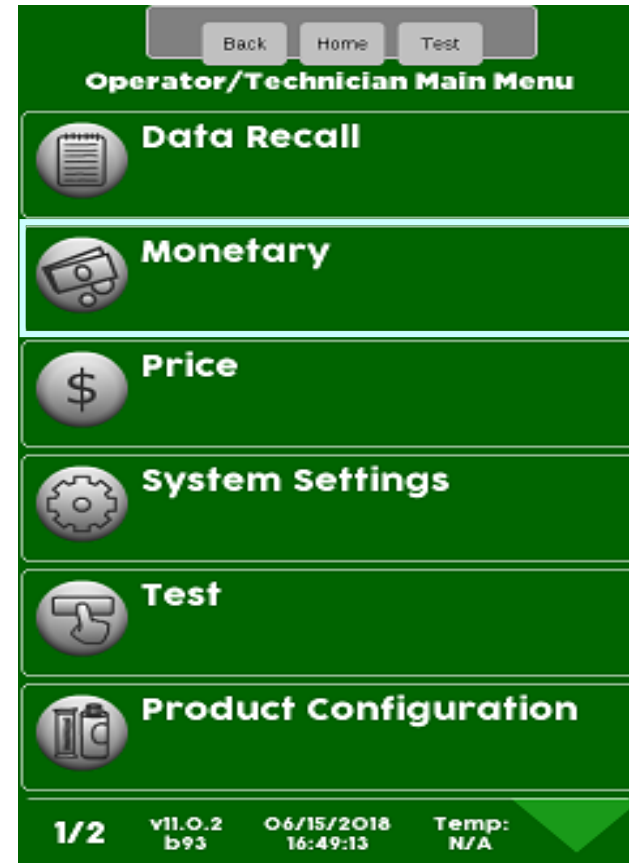



Monetary Menu

The Monetary Menu

- MDB Level
- Bill Validator
- Stack Bills
- Card Reader A&B
- Bill Acceptance
- Coin Mech Setting
- Coins In/Out
- Card Reader A & B
- Onboard Cashless
- MDB Cashless Cart
- MDB Cashless Postpay
- Show Currency Symbol
- Correct Change Parm
- Declining Balance
- Force Vend
- Accept on Low Change
- Low Change Message
- Credit For Failed Vend
- Cash Discount

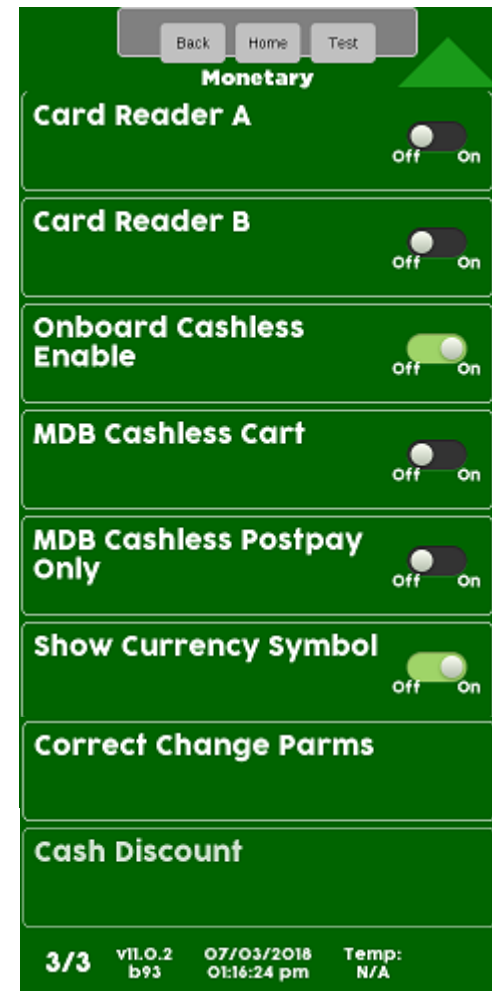
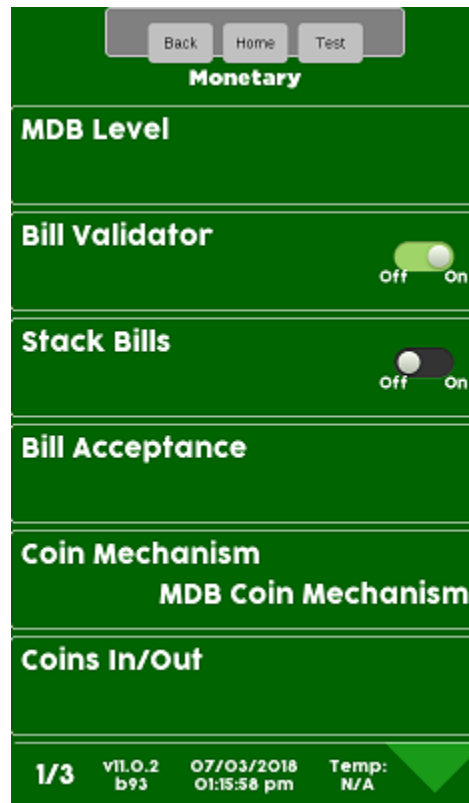

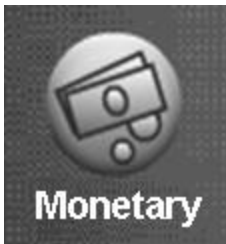

Monetary Menu

MDB Level

Touch MDB Level

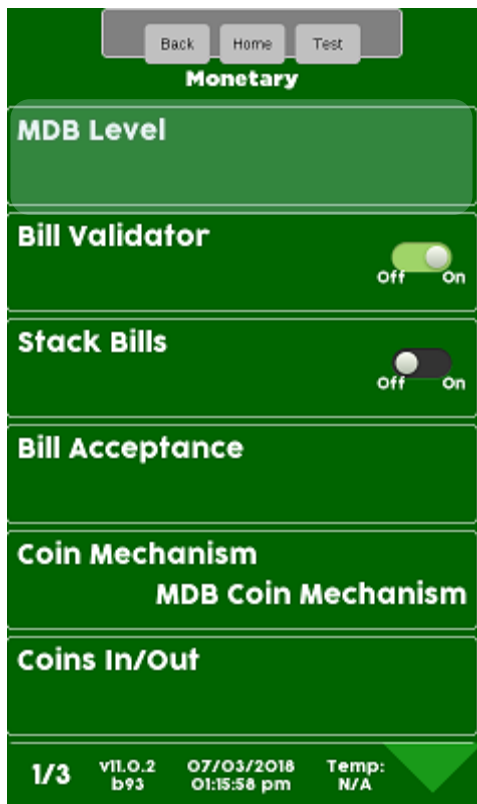

The display will show the MDB devices currently communicating and the level they are currently communicating at. This menu is only active when MDB peripherals are being used.

Back Home Test

MDB Level

Device	MDB Level
Coin Mechanism	3
Bill Validator	1

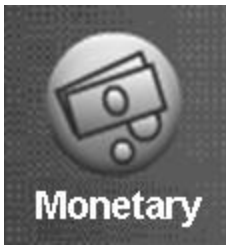

Monetary Menu

Bill Validator Enable

Touch Bill Validator to toggle between Bill Validator on and Off if no Bill Validator is installed.

- When the Bill Validator is set to off the machine will not accept bills.
- When Bill Validator is set to on the Bill Acceptance & Stack Bills Menus will be shown allowing you additional bill handling options.

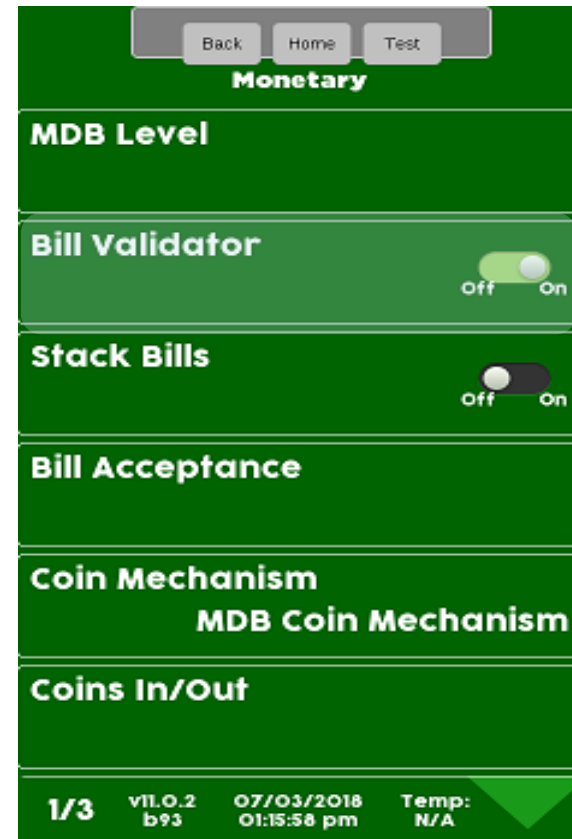



Monetary Menu

Stack Bills

Touch the Stack Bill Menu Bar to toggle between ON (stacked) and Off (Not Stacked).

- If ON (stacked) All bills accepted will be stacked immediately. If the coin return is depressed, change will be paid back.
- If OFF (not stacked) The machine will accept bills to the highest vend price. If the coin return is depressed the last bill inserted will be returned and all previous bills inserted will be returned in change.

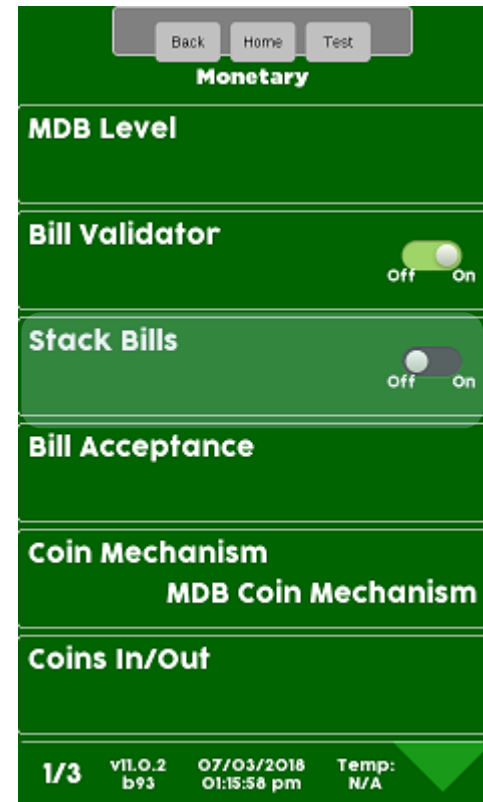

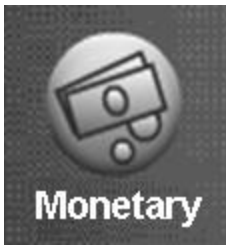

Monetary Menu

Bill Acceptance

Touch Bill Acceptance to enter the menu. All denominations the Validator is capable of accepting will be shown.

Touch the value on the display to select or unselect the bill/note denominations you wish to accept/not accept. The switches on the Validator must also be enabled. Token must be enabled to accept Tokens or Coupons. You will also need to choose what selections work with tokens or coupons in the Special Vend Modes Menu.

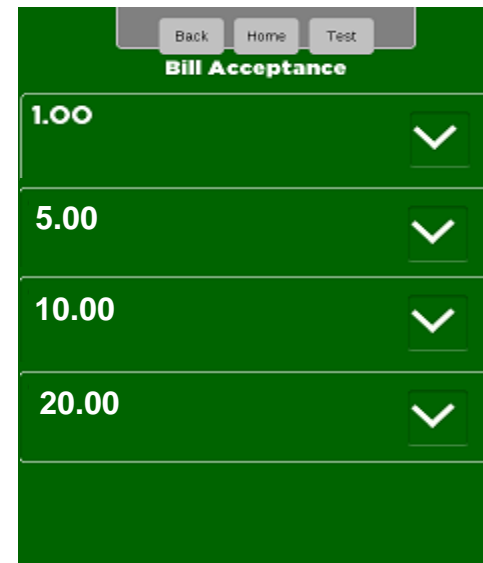
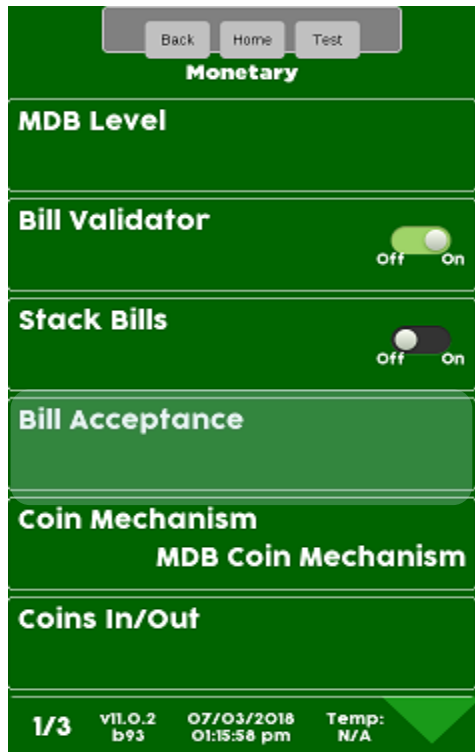

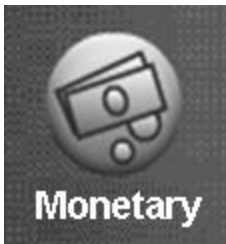

Monetary Menu

Coin Mechanism Enable

Touch Coin Mechanism to set the coin mechanism type. The current setting is shown without entering the menu.

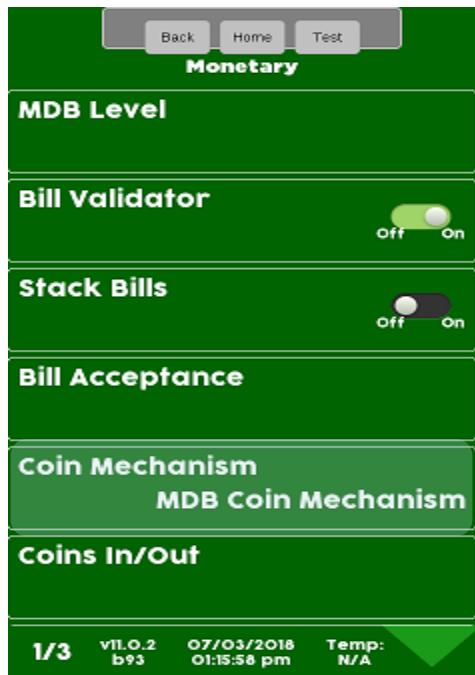

Touch the desired Coin Mechanism option and Accept to save.
Note: Exec is not used in the US.

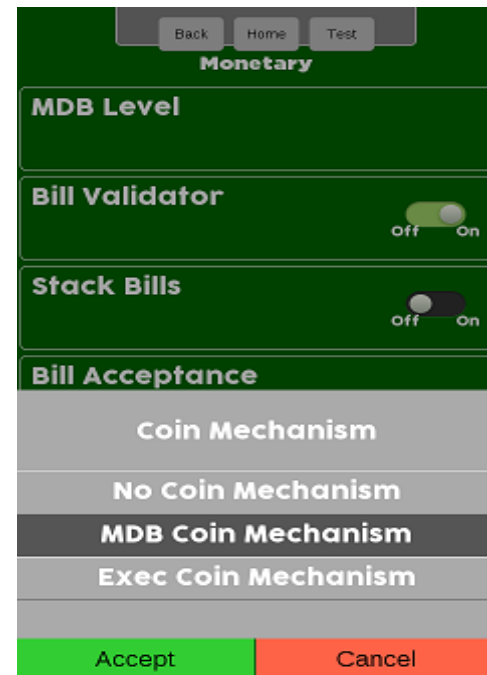

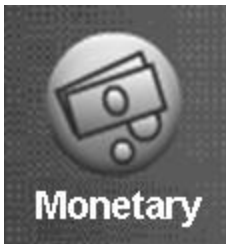

Monetary Menu

Coins In/Out

Touch Coins In/Out menu.

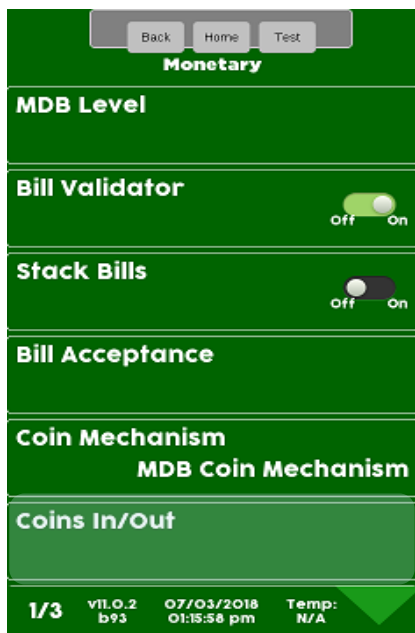

Press OK to acknowledge the instruction on the screen

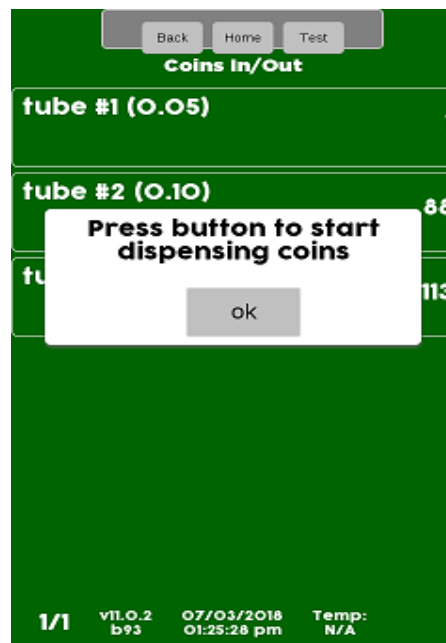

Touching the menu bar showing the value of each coin will cause that tube to start dispensing coins, press the menu bar again to stop dispensing coins. Note that to the right of each denomination, it shows how many of that coin are in the coin mech..



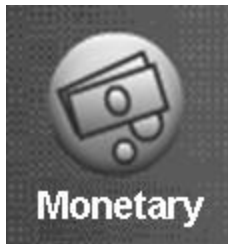

+  To page 2

Monetary Menu Card Reader Enable

Card Reader / Cashless Options

- There are three menu Bars as shown on the right for card reader and/or cashless options.
- There are two menus for MDB card reader and one for an onboard reader.
- MDB is an add on card reader that plugs into the MDB harness in the machine. Your options in this menu are MDB card reader or no MDB card reader.
- Onboard is a swipe built into the front of the machine.
- When using Onboard Cashless, an NFC (Tap and Go) option is available.
- Crane Onboard cashless interfaces with other online systems so in many cases we can accept credit and other cards College, work id etc., eliminating the need for a second card reader.
- It is possible to have two MDB card readers or one MDB and one Onboard reader in the machine at the same time. An example would be a college where you accept both credit cards and a college ID cards that are tied to students accounts.

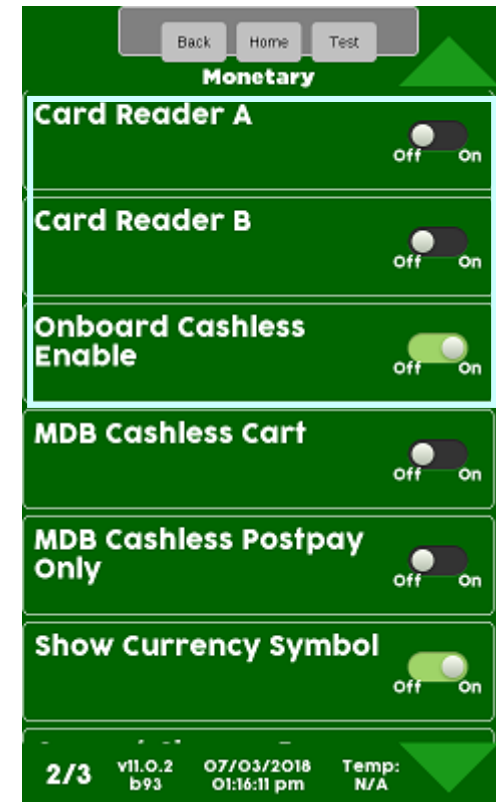

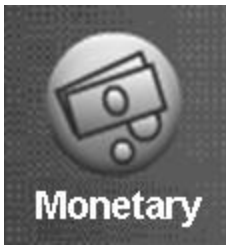

+  To page 2

Monetary Menu Card Reader Enable

Touch the Menu Bar for Card Reader A or B to turn on your MDB card reader option. If you have one MDB card reader choose card reader A. If you have two card readers make sure card reader B is both capable of and set to communicate as card reader B

Once you turn on either card reader A or B an additional menu will appear allowing you to choose an option to adding value to a card. This is seldom used and currently is only available in a closed network and not used with credit cards.

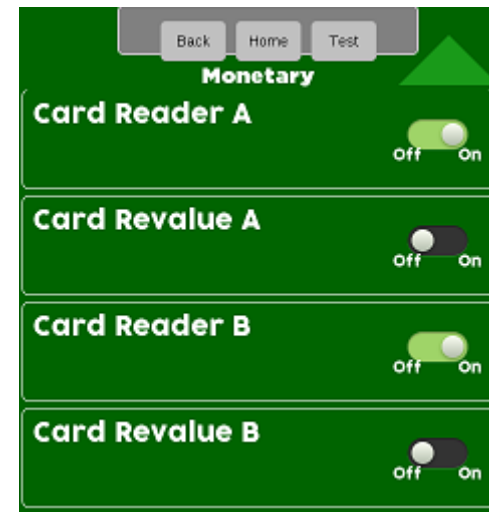
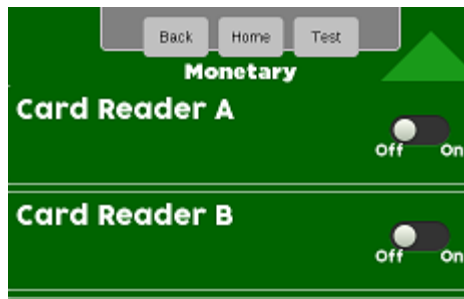

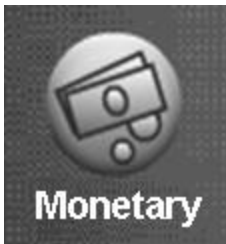

+  To page 2

Monetary Menu

Onboard Cashless Enable

Touch the Onboard Cashless Menu Bar Enable to toggle between Yes and No. An Onboard card reader is a built in card swipe on the front of the machine that plugs directly into the Atlas controller at J42.

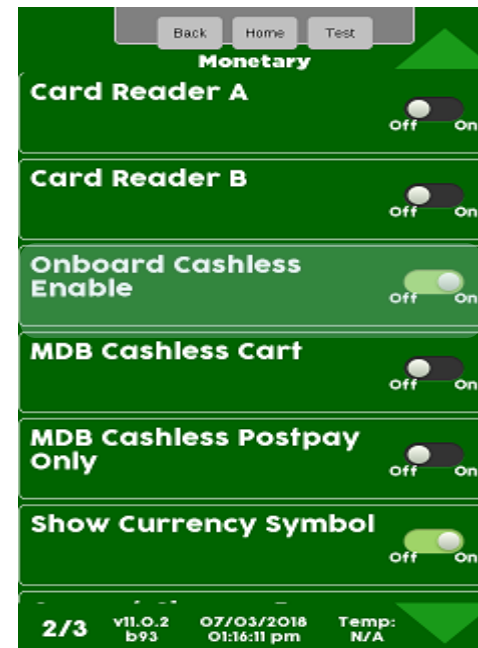



Monetary Menu

Onboard Cashless Enable

- Crane Onboard Cashless accepts NFC (tap and go) transactions.
- If you have a separate NFC reader installed, as long as the onboard card reader is assigned and enabled and the NFC reader cable is connected to a USB port on the controller the NFC reader will work.
- The radio should be plugged into USB 1.
- We recommend connecting the USB cable for the NFC reader into USB 2.

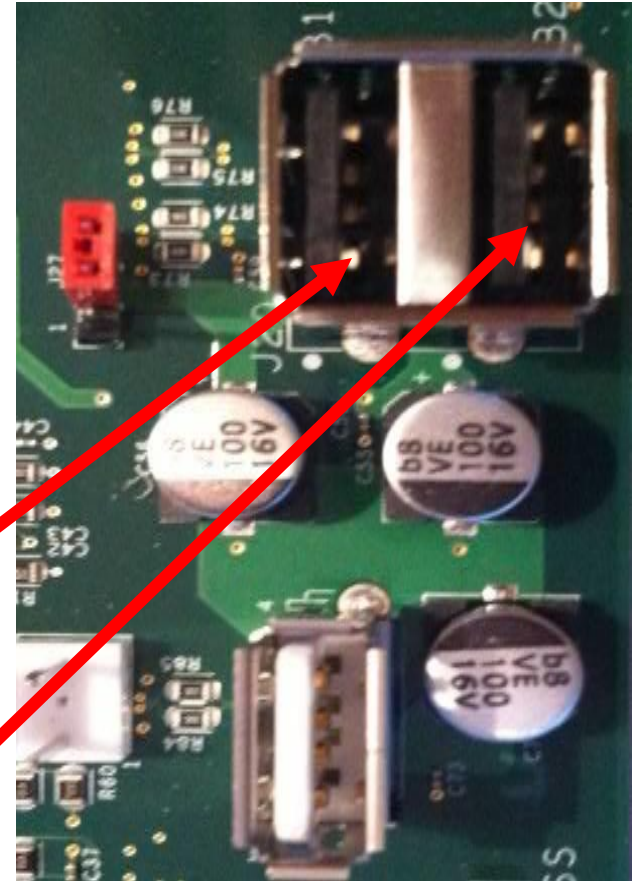

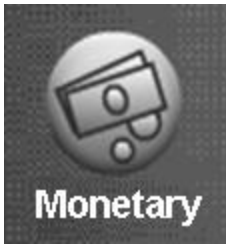

+  To page 2

Monetary Menu

Card Reader Cashless Cart / Postpay

Touch the Menu Bar for MDB Cashless cart to turn it on. If turned on it allows MDB card readers to be used with the shopping cart.

Touch the Menu Bar for MDB Post Pay to toggle between Yes and No. Select Yes only if Post Pay is to be enabled.

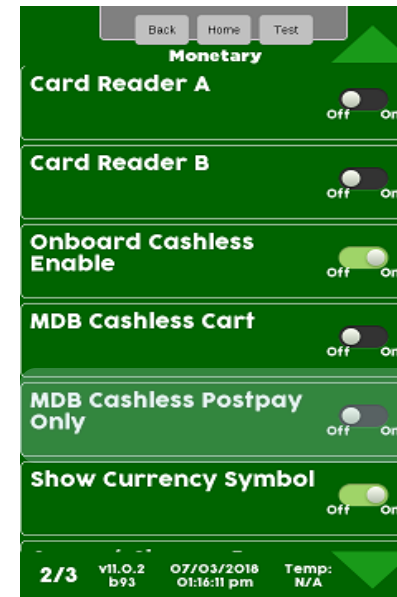
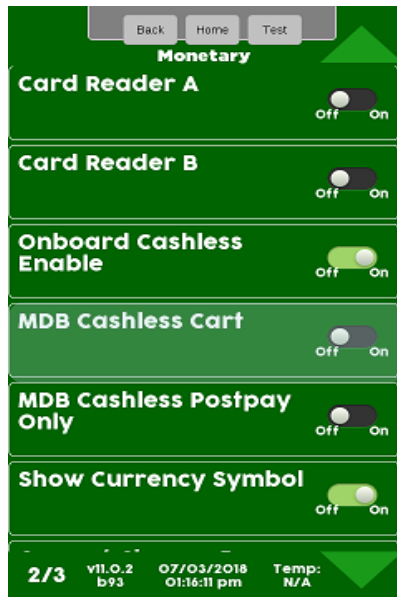

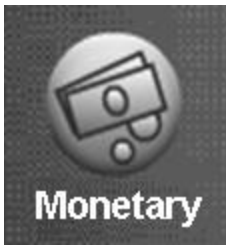

+  To page 2

Monetary Menu Currency Symbol

Touch the Menu Bar for Currency Symbol toggle between On and Off.

- If Turned on the Currency Symbol will be shown when applicable.
- If turned off the Currency Symbol will not be shown in any menu.

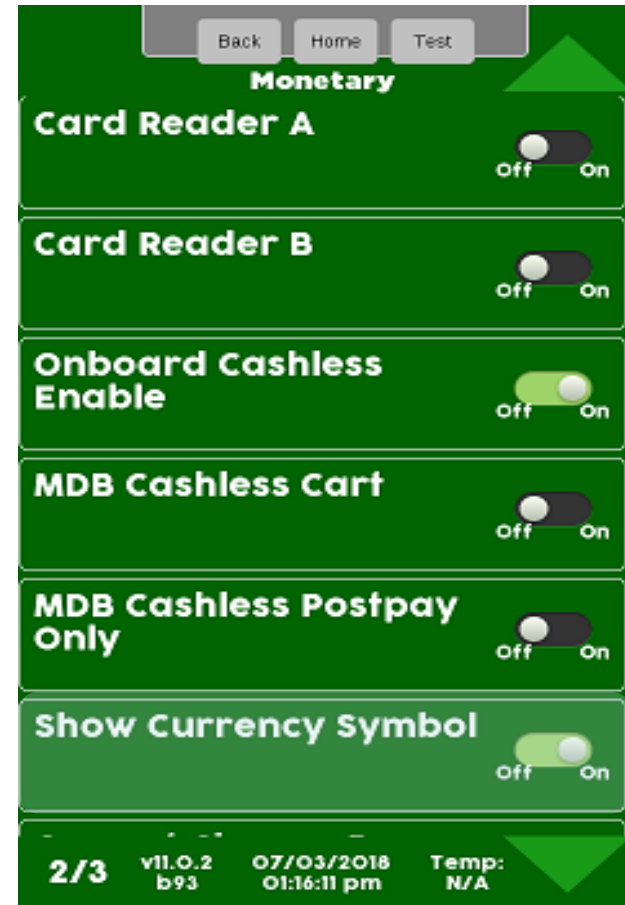

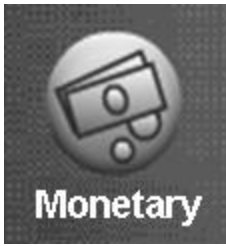

+ [Green envelope icon] + [Green envelope icon] to page 3

Monetary Menu

Correct Change Parameters

Correct Change Parameters

- The Touch the Correct Change Params Menu bar allows access to the following sub menus that allow the operator to set the payback parameters in the machine.
- Force Vend
- Declining Balance
- Accept on Low Change
- Low Change Message
- Credit for Failed Vend
- Allow Customer Overpay

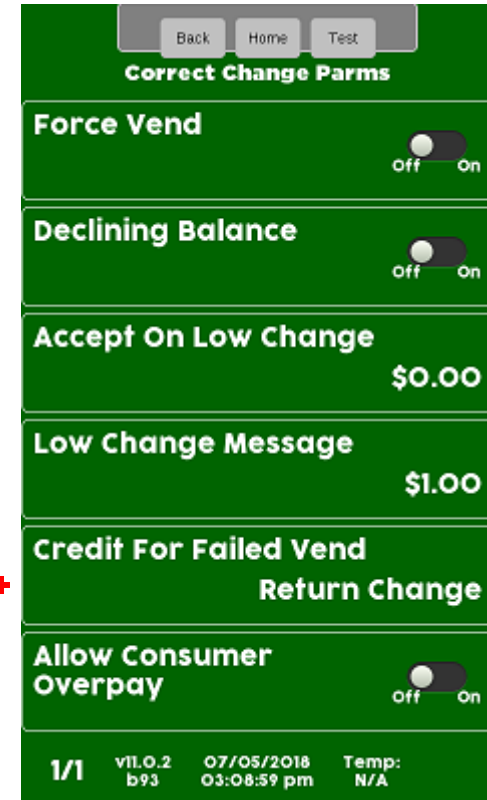
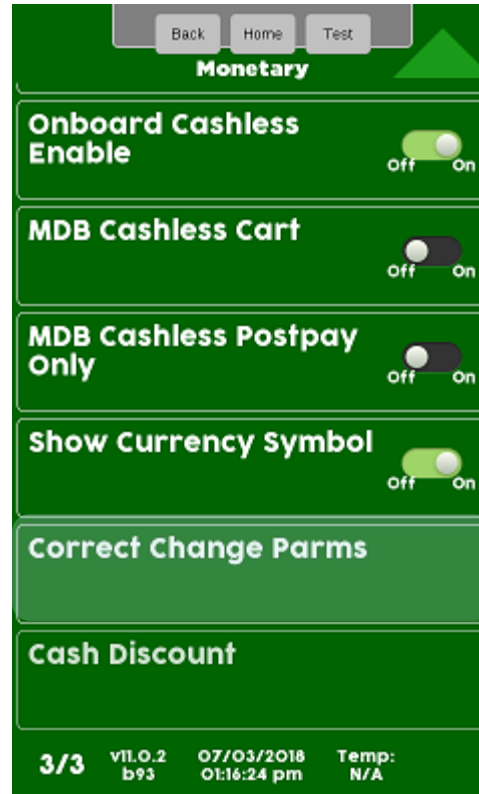

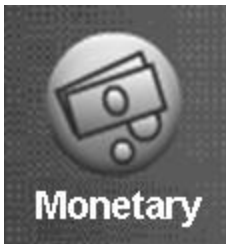

Monetary Menu

Correct Change Parameters - Force Vend

Force Vend

Touch Force Vend to Toggle Between Yes and No.

When Force Vend is set to **No**:

- All money inserted can be paid back by pressing cancel to end the transaction.

When Force Vend is set to **Yes**, a consumer will not be able to receive their credit back when:

- The established credit meets or exceeds the minimum price of the selections in the machine.
- Any bills are stacked in establishing credit.
- Any non-tube coins are inserted in establishing credit
- A “No Change Without Purchase” message will be displayed when a consumer attempts to return credit.

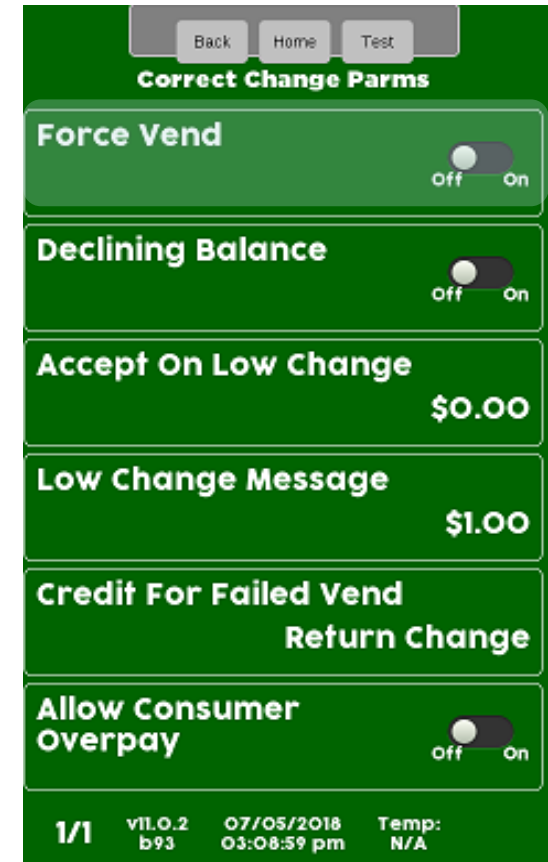



Correct Change Parameters - Declining Balance

Declining Balance

- Touch Declining Balance to toggle between Off and On.
- If Declining Balance is set to Off at the end of vend any change due back to the customer will be paid back immediately.
- If Declining Balance is set to On the change due back after a vend will remain on the display allowing the customer to add more money to make an additional purchase. **Note: If set to Yes, customer may touch Cancel to return remaining credit.**

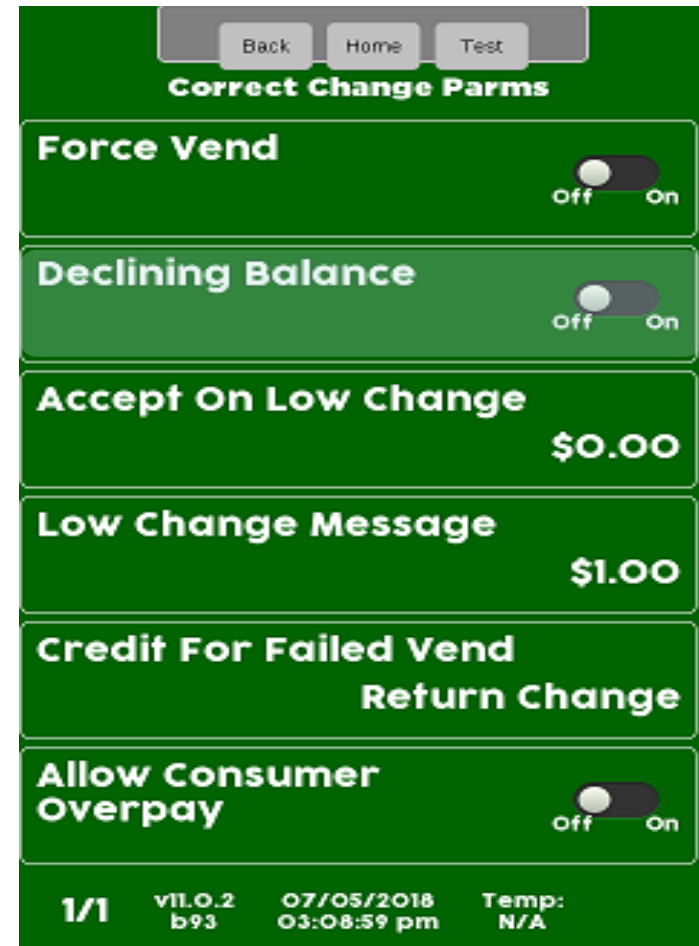

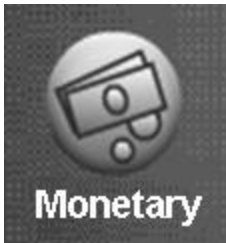

Correct Change Parameters - Accept on Low Change

Accept On Low Change

- Used to set acceptance of a bill depending on how much change is available in the coin mechanism.
 - If set to default \$0.00, the machine will only accept a bill when the coin mechanism has enough change to pay back full credit.
 - If a value is set to anything other than \$0.00 bills will be accepted to the set value even though change may not be available (the customer may get short changed).

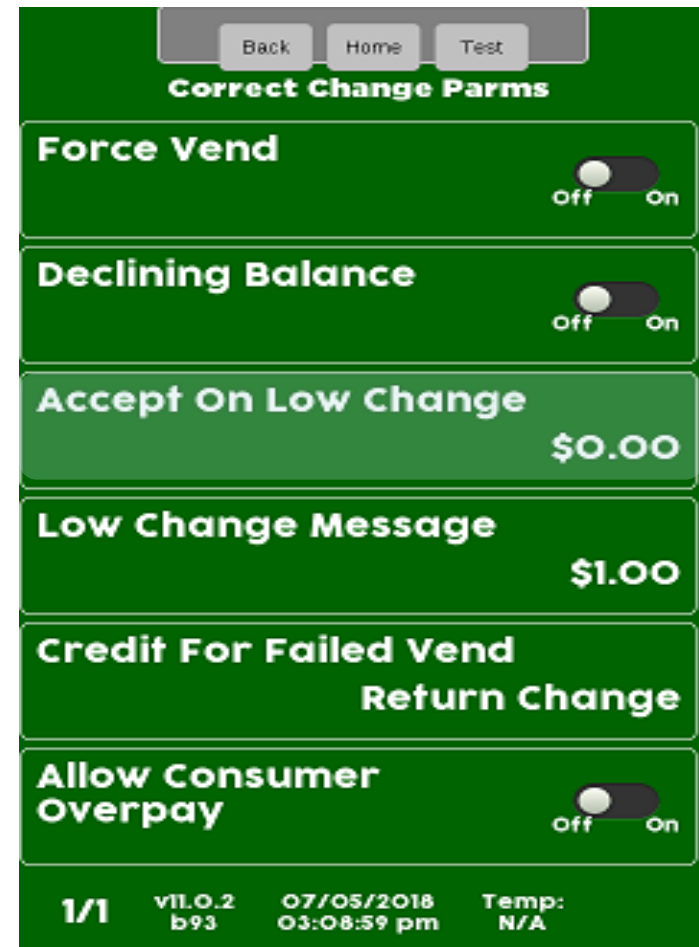

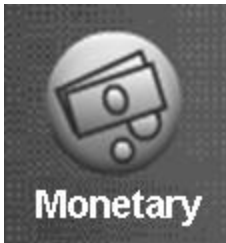

Monetary Menu

Correct Change Parameters - Accept on Low Change

Touch Accept on Low Change to bring up a screen that allows you to set a value

Back Home Test

Correct Change Params

Force Vend Off On

Declining Balance Off On

Accept On Low Change \$0.00

Low Change Message \$1.00

Credit For Failed Vend
Return Change

Allow Consumer Overpay Off On

1/1 VII.O.2 07/05/2018 Temp:
b93 03:08:59 pm N/A



Enter the value of money you wish to accept when no change is available. Setting this to anything other than \$0.00 may cause the customer to get short changed. Touch Accept to save.

Accept On Low Change : \$0.00

1	2	3
4	5	6
7	8	9
C	0	⊗

Accept Cancel

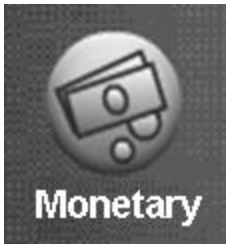

Correct Change Parameters – Low Change Message

Low Change Message

- Used to set the lowest amount registered in the coin mechanism before the display shows “USE EXACT CHANGE”
- Touch Low Change Message to enter lowest value on corresponding line (default setting of \$1.00 recommended).
- Touch Accept to save the setting.
- Touch Back to exit this menu mode.

A screenshot of the "Correct Change Params" menu. The menu is green with white text. At the top, there are three buttons: "Back", "Home", and "Test". Below the title, there are several settings:

- Force Vend**: A toggle switch set to "Off".
- Declining Balance**: A toggle switch set to "Off".
- Accept On Low Change**: A text input field showing "\$0.00".
- Low Change Message**: A text input field showing "\$1.00".
- Credit For Failed Vend Return Change**: A text input field.
- Allow Consumer Overpay**: A toggle switch set to "Off".

At the bottom, there is a status bar with the following information: "1/1", "v11.0.2 b93", "07/05/2018 03:08:59 pm", and "Temp: N/A".

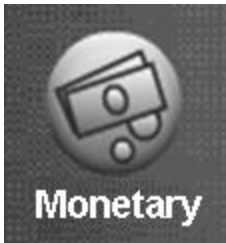

Monetary Menu

Correct Change Parameters – Low Change Message

Touch Low Change Message to access a screen that allow you to change the Value.

Enter lowest value of change available before the display shows the Low Change Message (setting of \$1.00 recommended).
Touch Accept to save

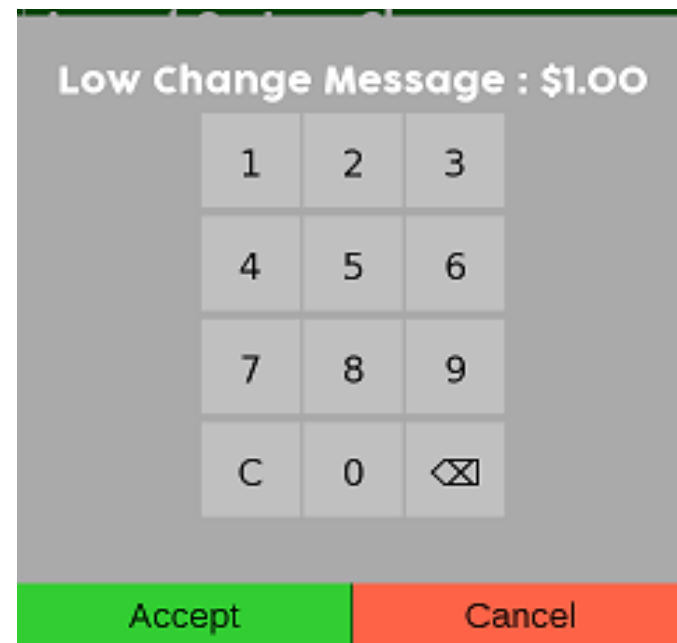

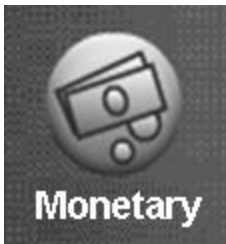

Correct Change Parameters - Credit for Failed Vend

Credit For Failed Vend

- Press Credit for Failed Vend on the keypad to change between the two settings:
 - **Return** = In the event of a failed vend, the credit will be returned automatically.
 - **Hold** = In the event of a failed vend, the credit will remain on the machine allowing you to purchase another item or pressing Cancel to return the credit shown.

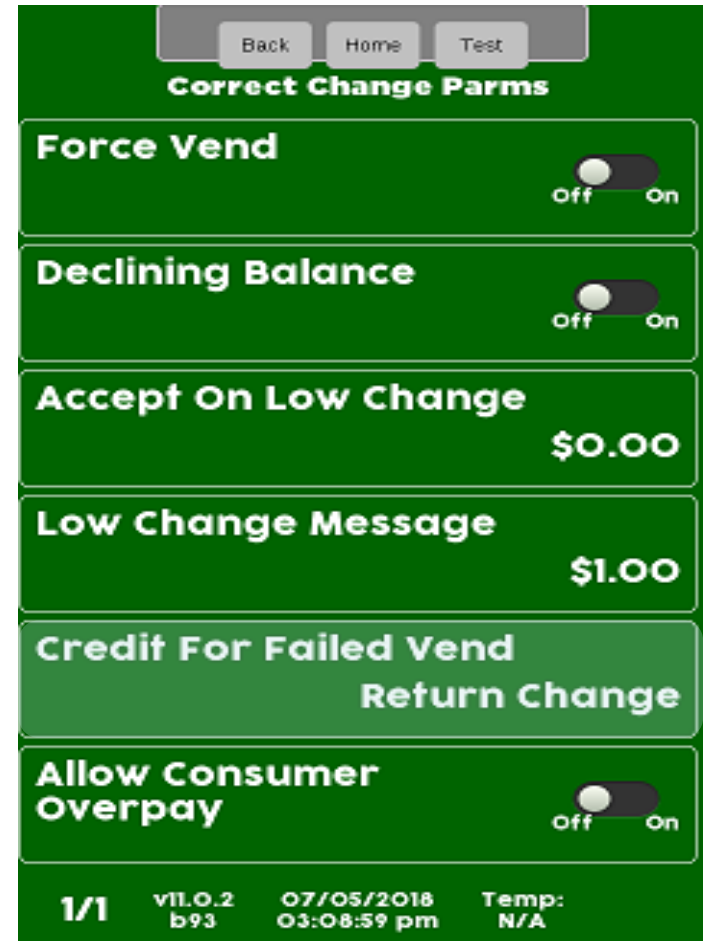

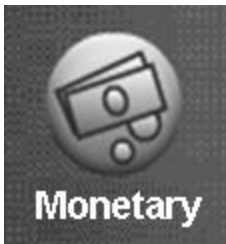

Monetary Menu

Correct Change Parameters - Credit for Failed Vend

Touch Credit For Failed Vend to advance to the next screen

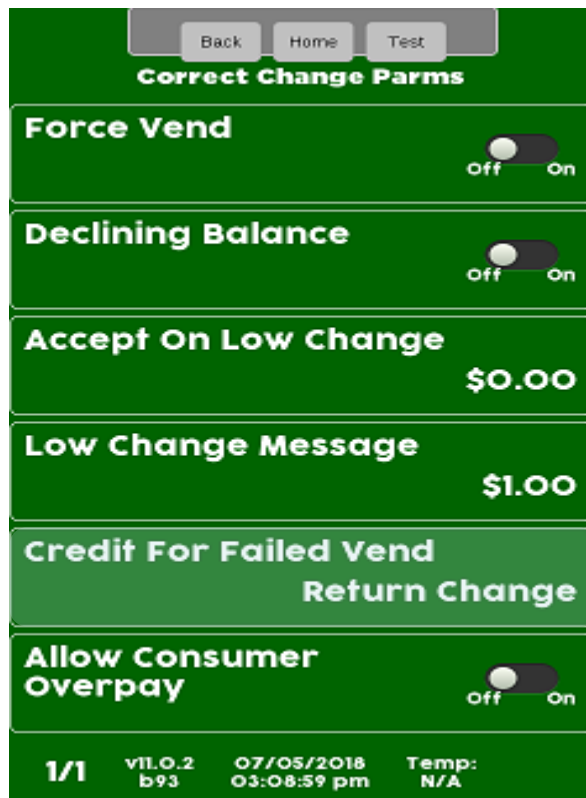

Touch Return Change or Hold Credit after a failed vend.
Touch Accept to save.

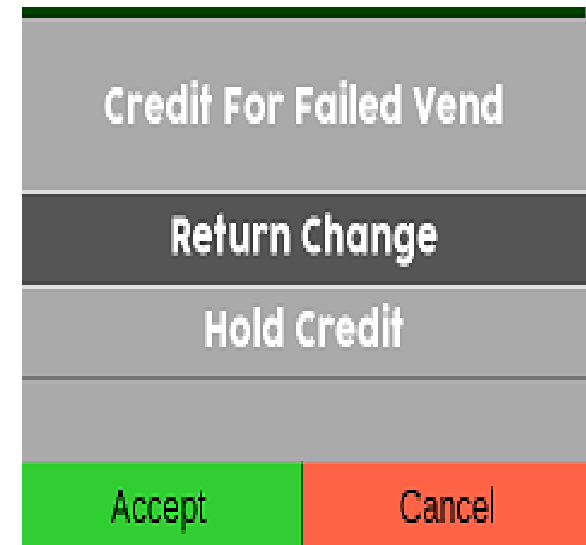



Correct Change Parameters – Allow Customer Overpay

Allow Consumer Overpay

- Touch the Menu Bar to toggle Customer Overpay between Off and On.
- When Consumer Overpay set to Off, the machine will not accept any currency for which it cannot make change, regardless of Low Change Message Setting or Accept on Low Change Setting.
- When Consumer Overpay set to On, based on other settings in the machine the customer would be allowed to make a purchase even if change is not available. This could result in a potential situation where the consumer gets short changed.

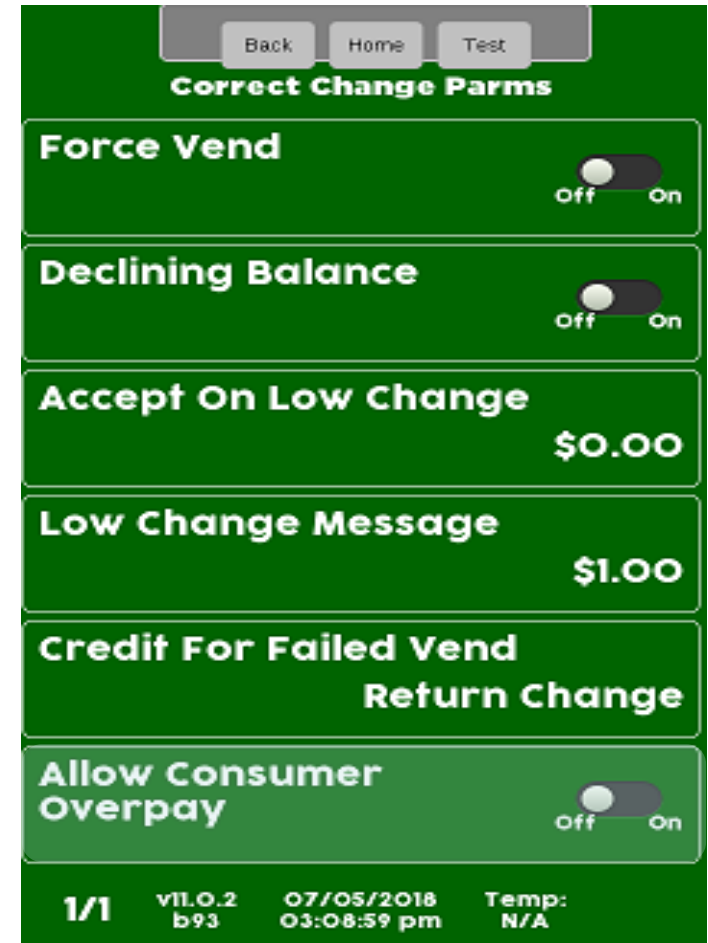



Monetary Menu

Cash Discount

Cash Discount

- This menu shows your current discount for cash.
- This only applies to onboard cashless transactions.
 - The Cash Discount can not be changed at the machine.
 - The Cash Discount currently can only be set to 10 cents.
- For Crane cashless, cash discounts can be changed by device in your portal.
- When enabled, Cash Discount applies to all products in the machine.
- No discount is applied if any part of the transaction is cashless, even in a mixed tender transaction.
- Both Cash and Credit prices are shown at bottom of the shopping cart screen.
- The prices set in the machine and shown in the consumer and service mode screens are the cash sales prices. In other words, the cash discount has already been applied.

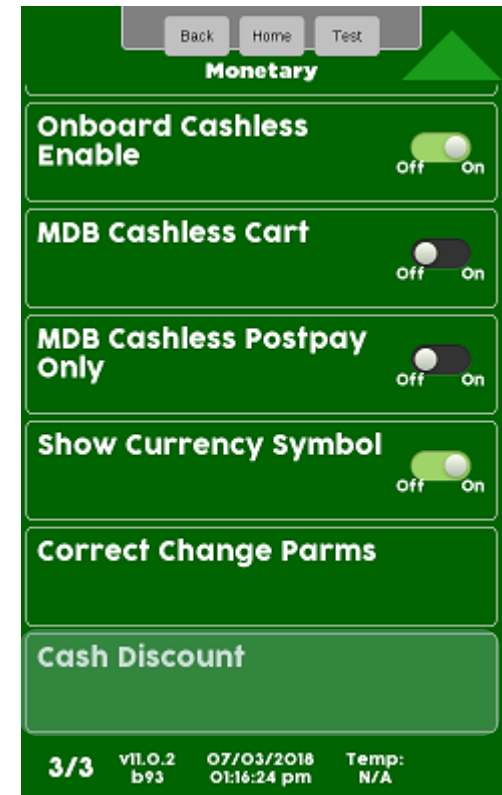



Price Menu

From the Main Menu Touch the Price Icon to access the Price Setting Menu.

There are three options for setting prices:

- By Tray
- Entire Machine
- Individual Prices

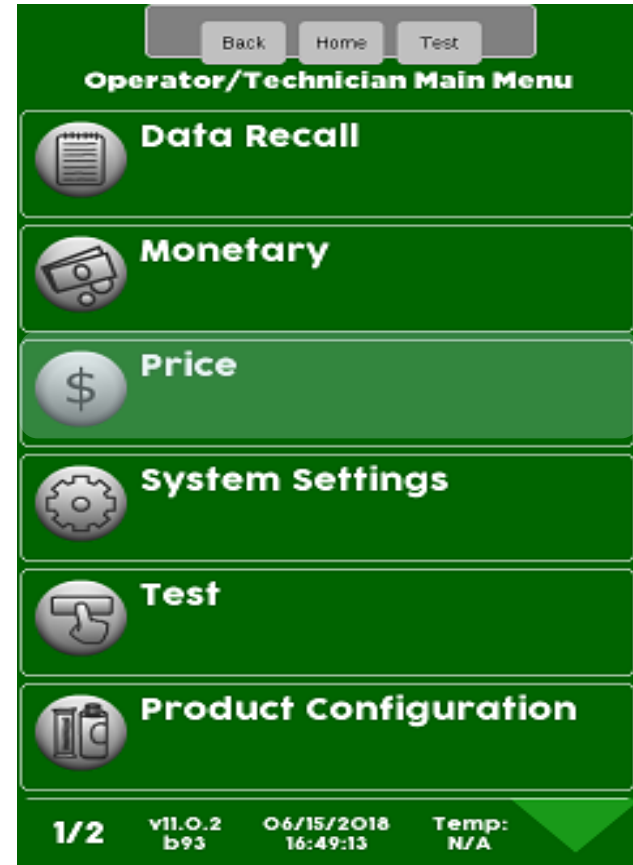



Setting Entire Machine Prices

Setting Prices by Entire Machine

- Touch Entire Machine on the display.
- A numeric keypad will appear on the screen along with a window to enter the price.
- Use the numeric keypad to enter the price for the Entire Machine.
- Press Accept to save or Cancel to exit without changing the price.

The screenshot shows a mobile application interface for setting prices. At the top, there are three buttons: "Back", "Home", and "Test". Below them is a green header with the word "Price". The main content area is divided into sections. The first section is "Entire Machine" with the text "No Price Entered" below it. The second section is "Tray #1" with the price "\$0.05" displayed to its right. Below these sections is a grey area containing the text "Entire Machine (\$0.00-\$10000.00): \$1.00". Underneath this text is a numeric keypad with buttons for digits 1-9, 0, and a delete key (represented by a square with an 'X'). At the bottom of the screen, there are two buttons: "Accept" (green) and "Cancel" (orange).



Price Menu

Setting Prices by Tray

Setting Prices by Tray

- Touch the tray you wish to Price.
- Press the down arrow for additional trays.
- A numeric keypad will appear on the screen along with a window to enter the price.
- Use the numeric keypad to enter the price for the tray being set.
- Press Accept to save, or Cancel to exit without changing the price.

Back Home Test

Price

Entire Machine
No Price Entered

Tray #1 \$0.05

Tray #2 \$2.00

Tray #3 \$25 : 1.25

Tray #4 \$2.00

Tray #5 \$2.00

1/2 v1.0.2 07/23/2018 Temp:
b93 09:48:13 am N/A

Back Home Test

Price

Entire Machine
No Price Entered

Tray #1 \$0.05

Tray #1 (\$0.00-\$10000.00):
\$0.05

1	2	3
4	5	6
7	8	9
C	0	⊗

Accept Cancel



Price Menu

Setting Individual Prices

Step 1 –
Page down and choose
Individual Prices



Step 2 –
Touch a Tray



Step 3 –
Touch a Selection

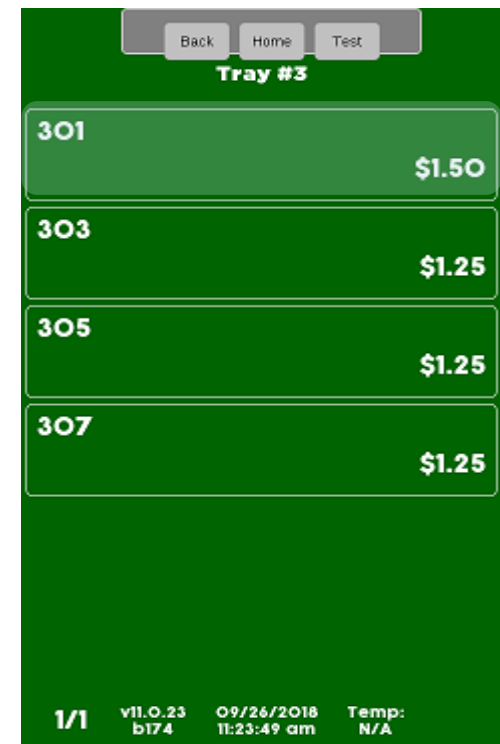



Price Menu

Setting Individual Prices

Setting Individual Prices

- A numeric keypad will appear on the screen along with a window displaying the current price.
- Use the numeric keypad to enter the new price for the that selection.
- Press Accept to save or Cancel to exit without changing the price.

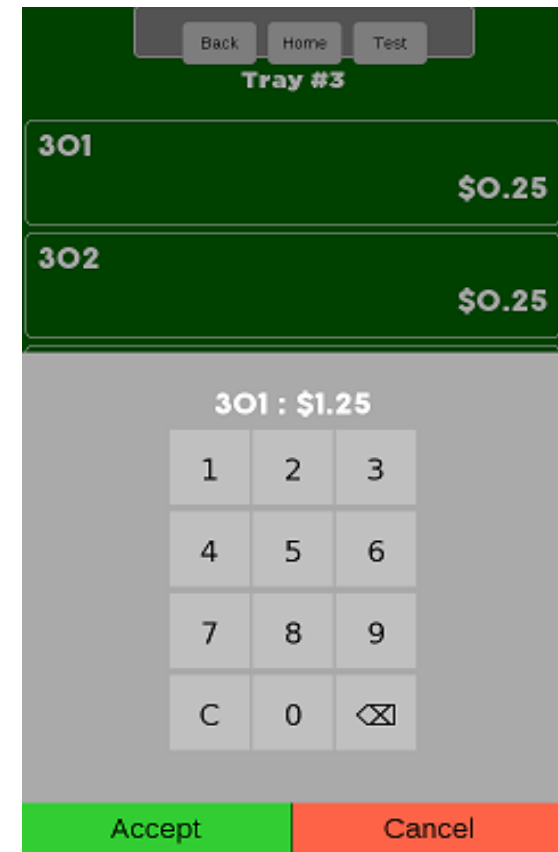



System Settings

Systems Settings Menu Bar

- Allows you to program the overall systems functions.
- Touch System Settings icon to enter the Menu.

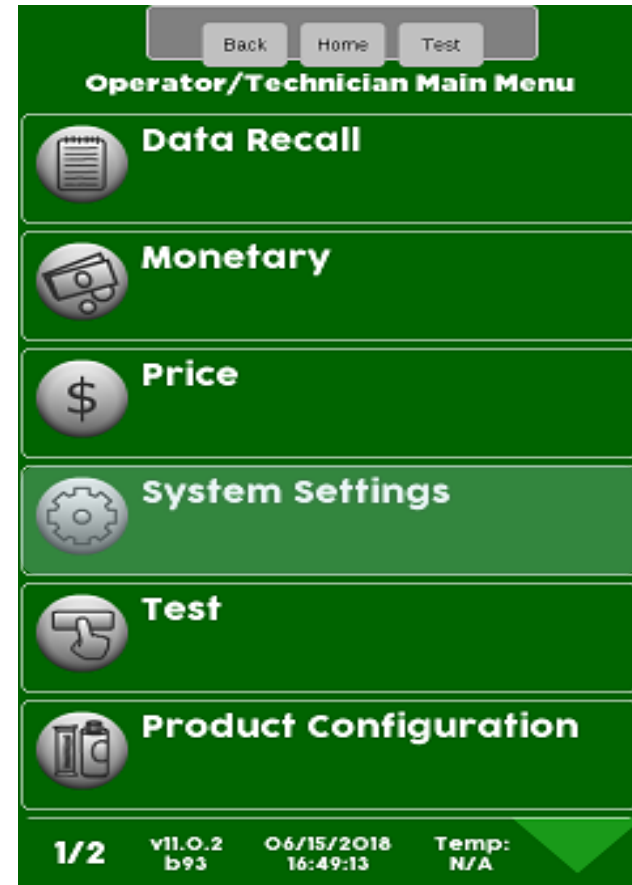



System Settings

System Settings

- Touching the System Setting Menu Bar from the home screen allows access to the System Settings Menus shown on the four screens to the right.
- Touch the down arrow to scroll to the next menu screen.
- Touch the up arrow to return to the previous menu screen.

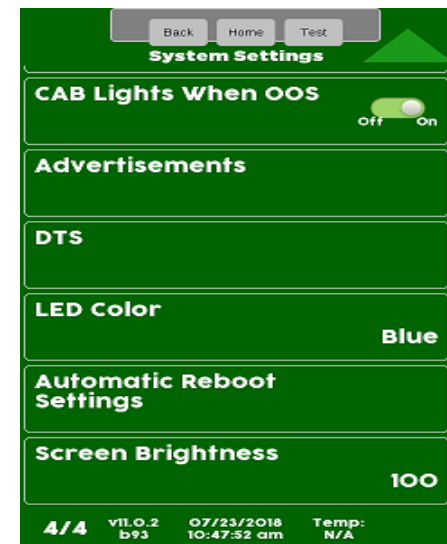
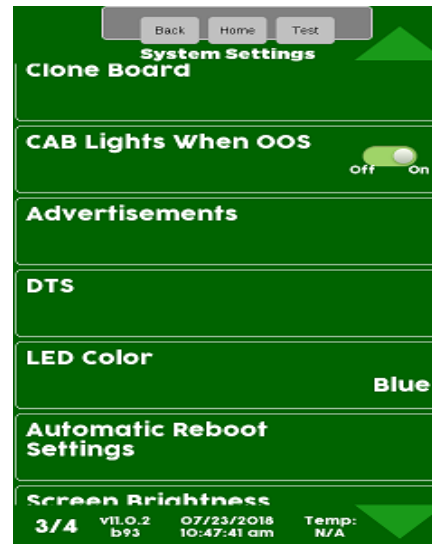
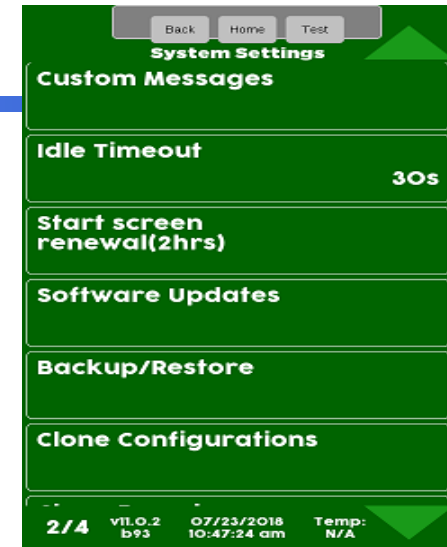
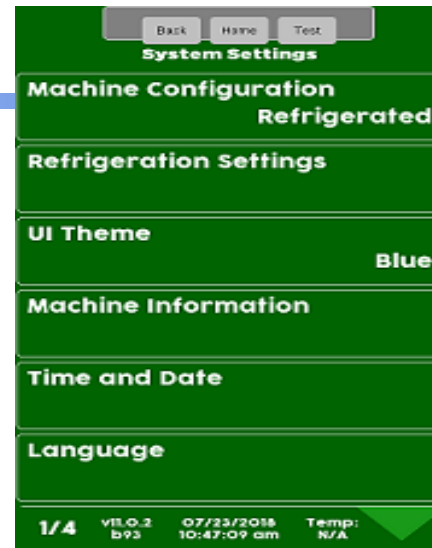



System Settings

Configuration Version

The current setting is shown without entering the menu. Touch Configuration Version to enter the menu.

Touch to select the desired Configuration Setting. Do not use European Control in the US. Touch Accept to save.

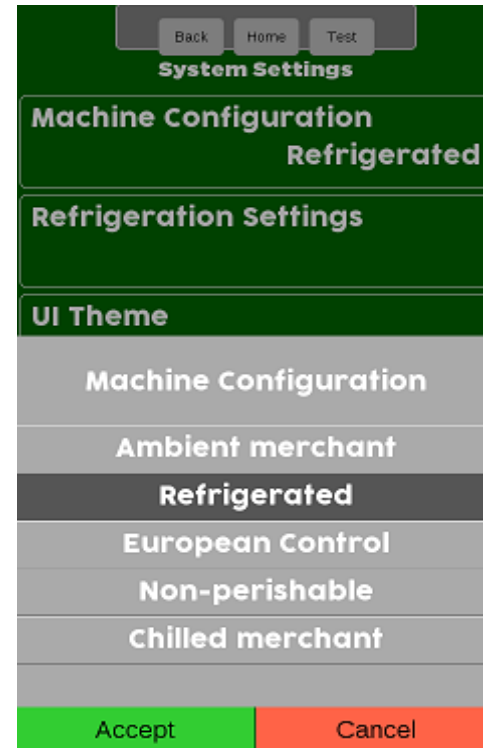
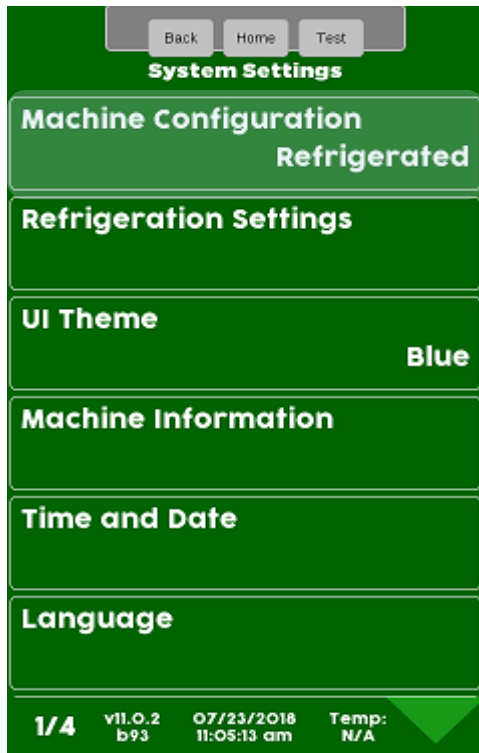



System Settings

Refrigeration Settings

If Ambient is set in the Configuration menu you will not have a Refrigeration Menu Bar. Touch Refrigeration Settings to enter the menu.

Touch a menu bar below to access the corresponding Refrigeration menu.

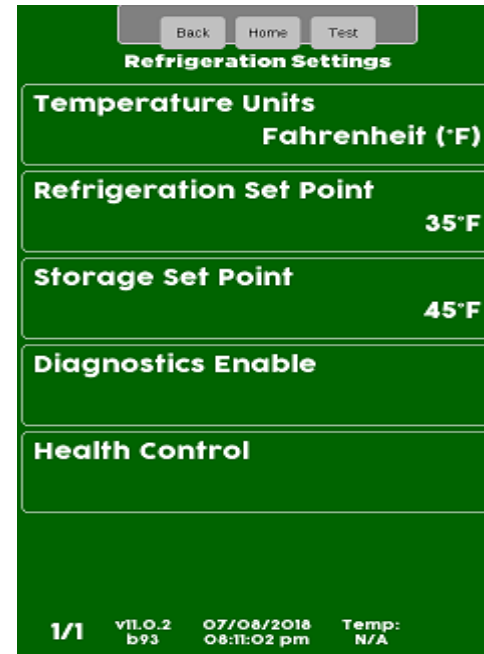
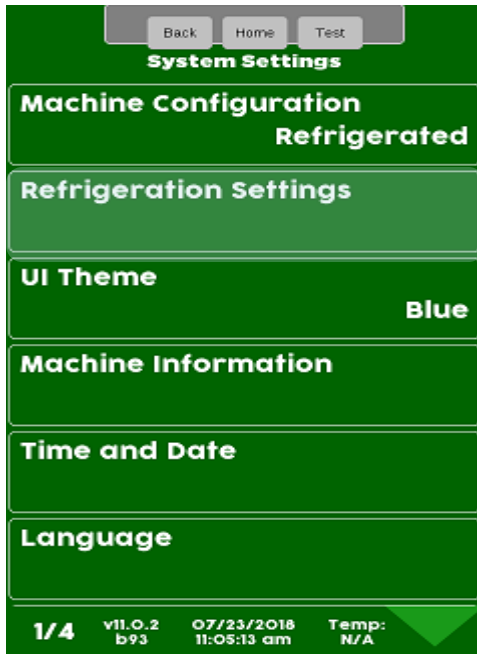



System Settings

Refrigeration Settings – Temperature Units

Touch Temperature Units to change the viewable Temperature between Fahrenheit and Celsius

Choose Fahrenheit or Celsius and touch Accept to save.

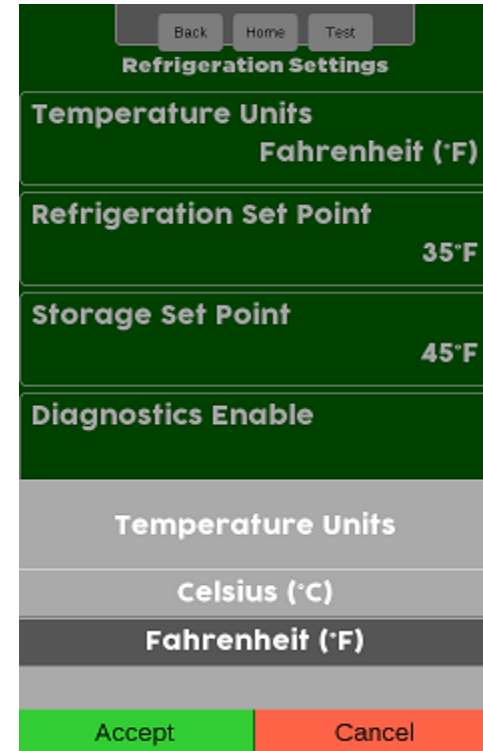
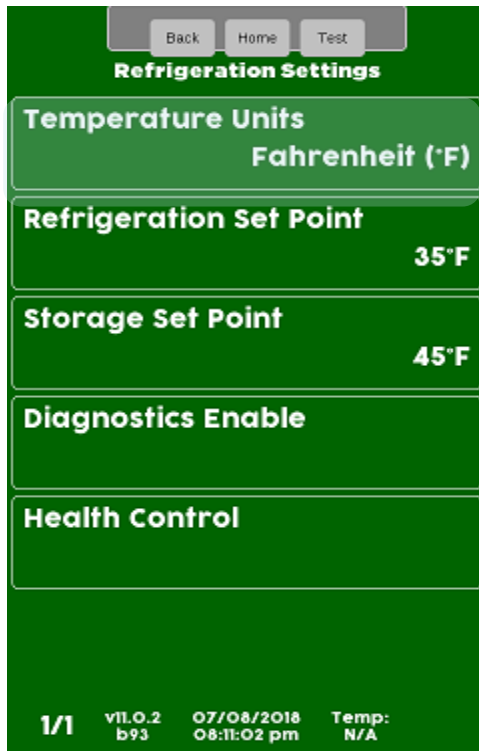



System Settings

Refrigeration Settings – Adjust Temperature

Setting the Temperature Range

- In Ambient machines this menu will not appear.
- Refrigerated temperature is settable from 33-38°F (1-3°C) and the health control menu will be available.
- Non Perishable temperature is settable from 33-45°F (1-7°C) and the health control menu will not be available.
- Chilled temperature range is from 49-69°F (9-21°C) and the health control menu will not be available.

Touch Refrigeration Set point to adjust the temperature

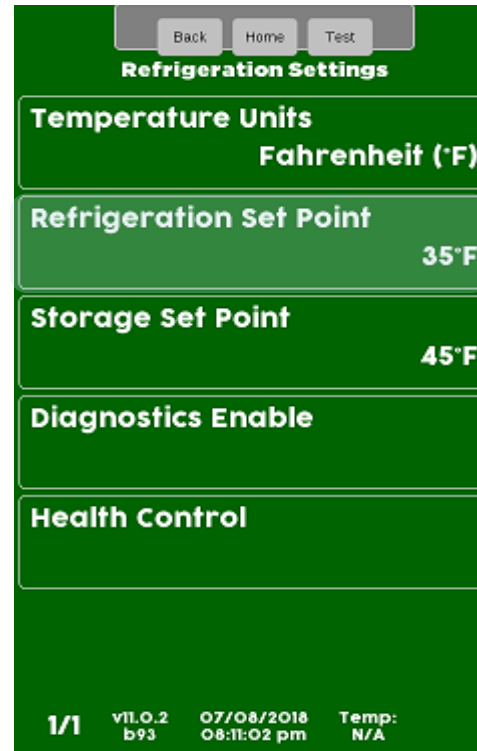

On the keypad enter the desired Temperature. Touch Done to save!

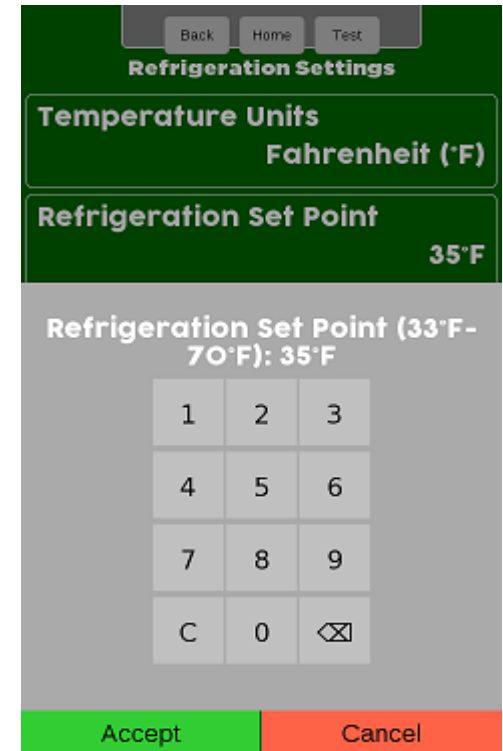



System Settings

Refrigeration Settings – Storage Set Point

Touch Set Storage Point
to enter the Menu

Set the desired Storage Point
target temperature for when the
machine is in storage mode.

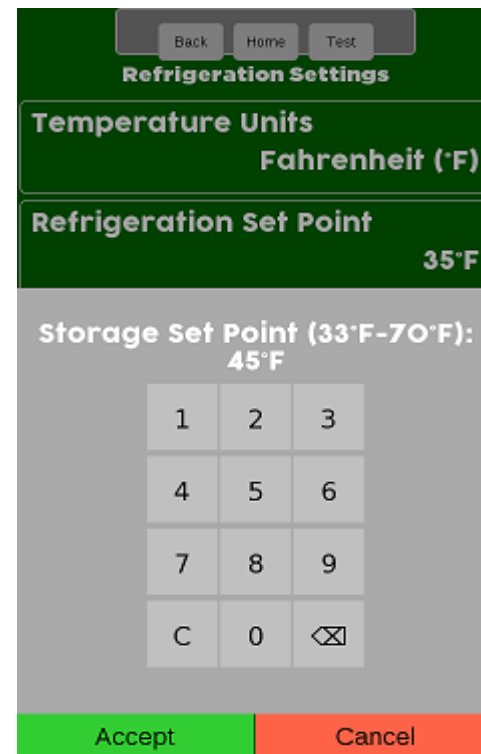
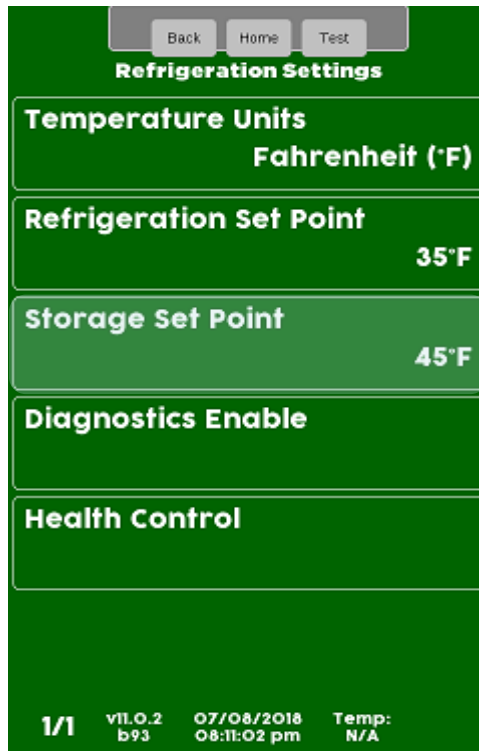



System Settings

Refrigeration Settings – Diagnostics enable

The Diagnostic Enable menu allows you to turn on or off the warning and errors reported by the evaporator sensor and condenser sensor. These errors are reported when the door is opened if they exist. The default is on for both warnings & errors, and an Error is more severe than a Warning.

High Side errors & warnings are created when the Condenser Outlet Sensor is out of Range, most likely due to blocked inlet screen, dirty condenser, or condenser fan failure

- Warning: If the Condenser Outlet Sensor is greater than 125°F (52°C) for the 30 Minutes.
- Error: If the Condenser Outlet Sensor is greater than 150°F (66°C) for 5 minutes, **cooling is disabled. The error will need needs to be manually reset.**

Low Side errors & warnings are created when the unit goes into Low-Temp Defrost; where the Evaporator Coil Sensor is less than 10°F (-12°C) too frequently. Most likely due to an obstructed evaporator coil, low charge, or an evaporator fan failure.

- Warning: If the unit goes into Low-Temp Defrost at 10°F (-12°C) in more than 5 minutes, but less than 75 minutes after a previous defrost cycle.
- Error:, If the unit goes into Low-Temp Defrost 10°F (-12°C) in less than 5 minutes after a previous defrost cycle, **cooling is disabled. The error will need needs to be manually reset.**



System Settings

Refrigeration Settings – Diagnostics Enable Menu

Touch Diagnostics Enable to enter the Menu.

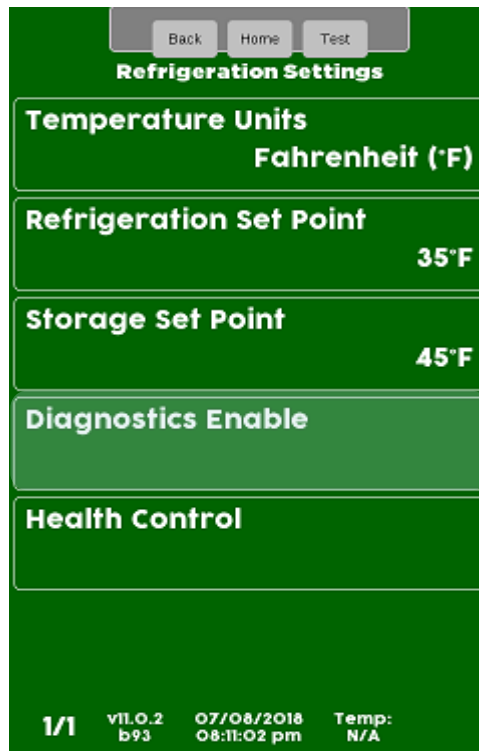

Each Warning and Error can be toggled between On and Off individually by touching the any of the menu bars below.

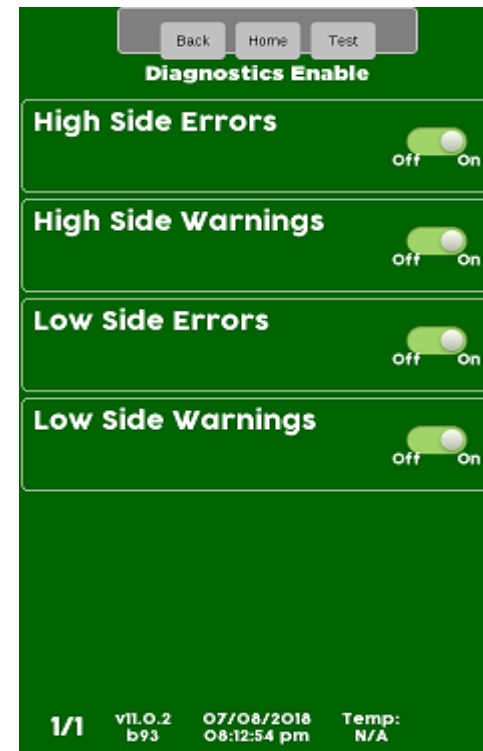



System Settings

Refrigeration Settings – Health Control

Touch Health Control to enter the Menu

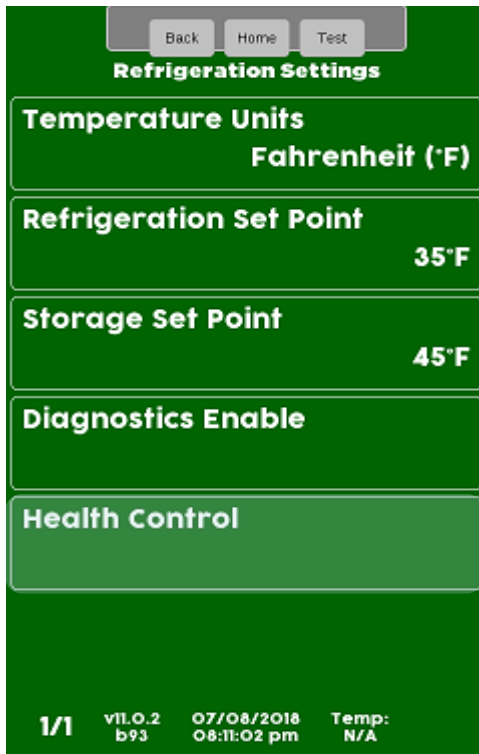

Touch Select All, Clear All or choose a tray number to check and/or change the current Health Control Status.



All available selections are shown. Touch select all, clear all or a selection to add a checkmark and enable selections for Health Control.

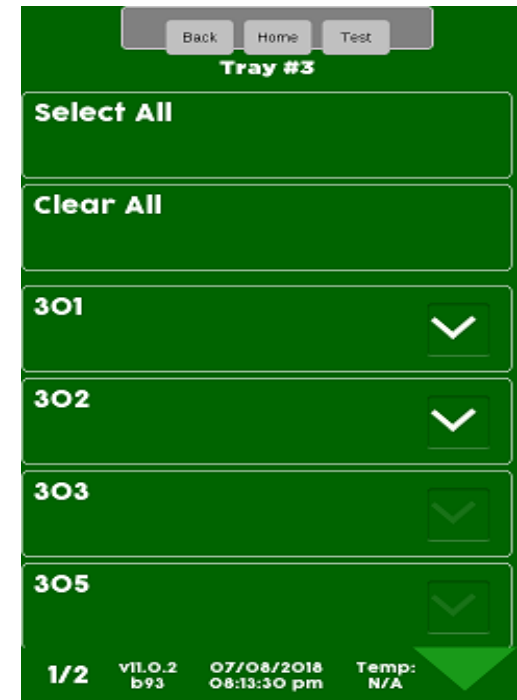

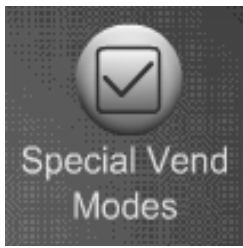

System Settings

User Interface Theme

User Interface (UI) Theme

- This Menu allows you to choose from a number of different user interface themes preprogrammed into the controller.
- Touch UI Theme and a window will pop up with the available UI themes.
- Select a New Theme by pressing the new color and then press Accept, or press Cancel to exit without making a change.

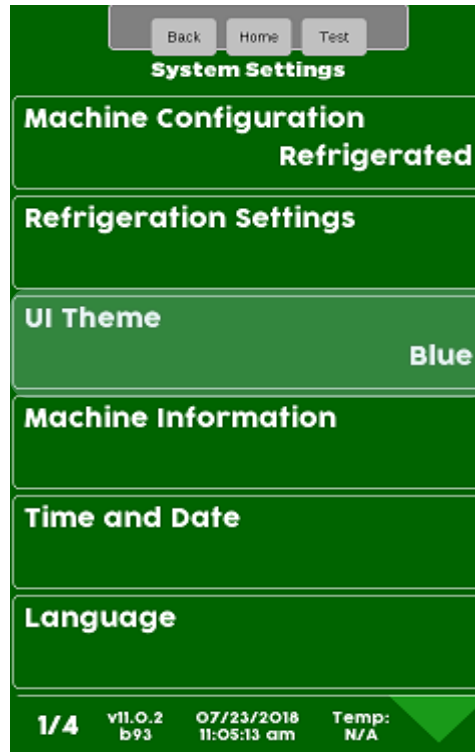



System Settings

Machine Information

Touch Machine Information to access and create Identification numbers used for Dex.

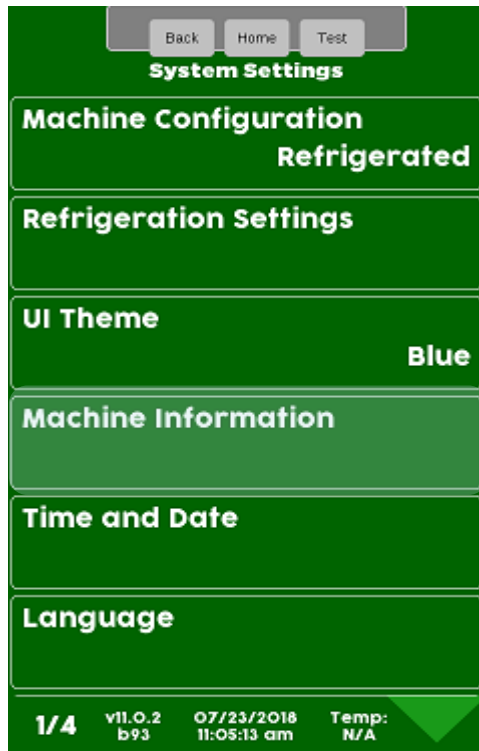



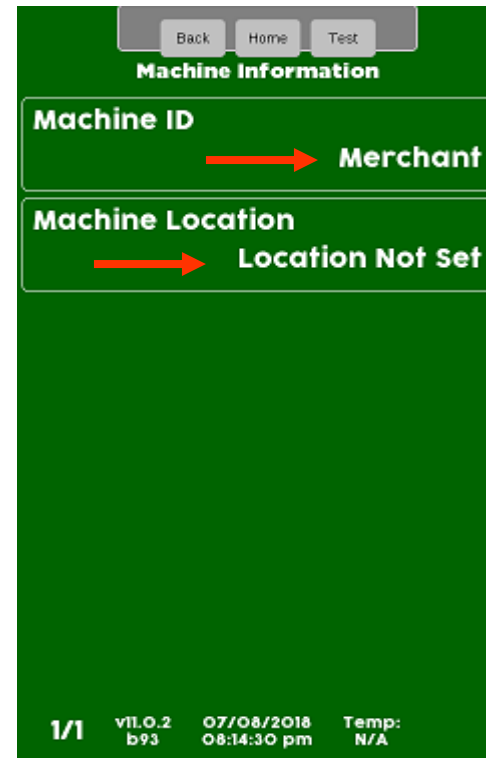



Touch Machine ID or Location ID to assign or change the number. This ID can be text, numeric or a combination both.





System Settings

Machine Information

- A keypad will appear on the screen along with a window to enter the ID or Location information.
- Use the keypad to enter the information.
- Touch Accept when finished
-  is your backspace key.
-  you to exit without changes.
-  switches the keypad to numeric.
-  switches the keypad to uppercase
-  switches to lowercase
-  switches the keypad to symbols and numbers.





System Settings

Time and Date

Touch the Time and Date menu bar to access the Time and Date Menu.

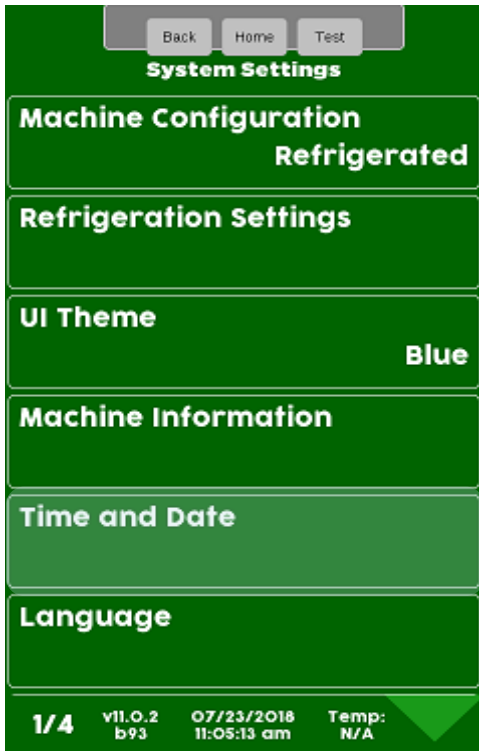

Touch Time Zone to change.

Note Warning about reboot

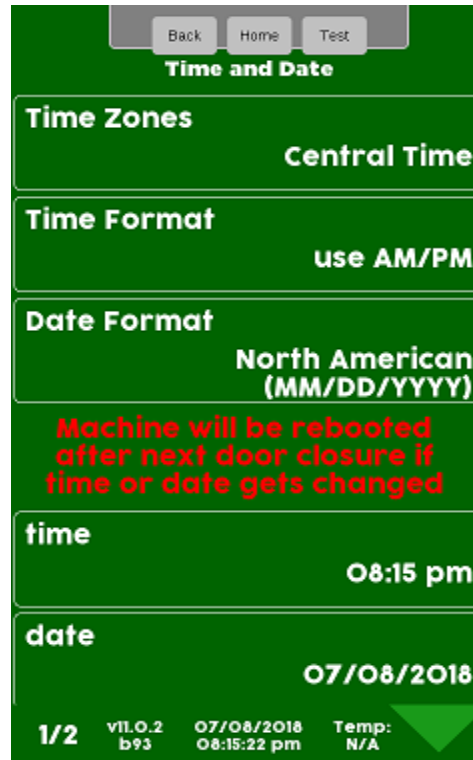

Touch your Time Zone followed by Accept.

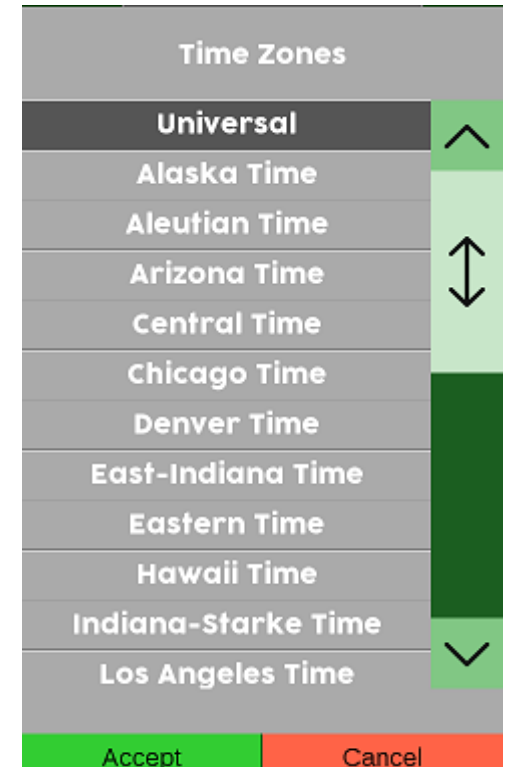



System Settings

Time and Date

Touch Time Format to change the Format between 24 hours and AM/PM.

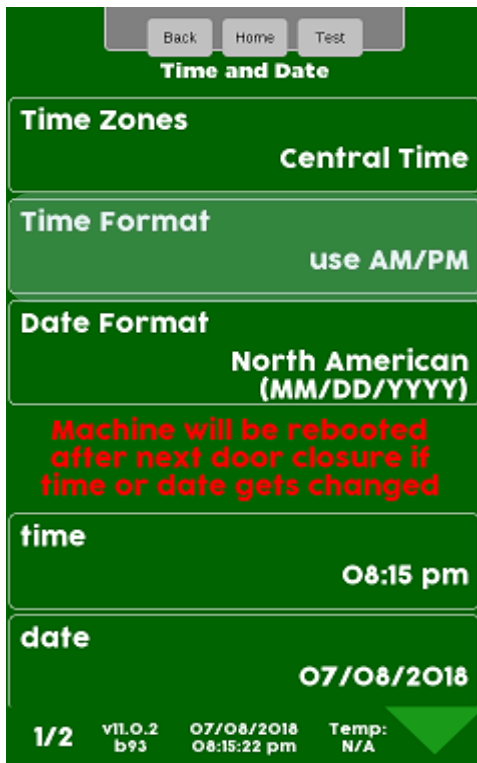

Touch your desired format AM/PM or 24hr clock. Touch Accept to save.

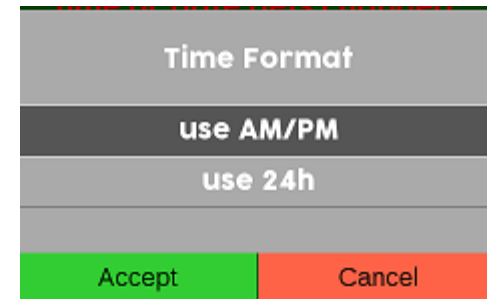



System Settings

Time and Date

Touch Date Format to change the Format between MM/DD and DD/MM.

Touch your desired format.
Touch Accept to save.

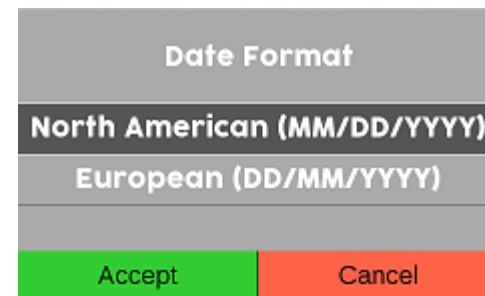
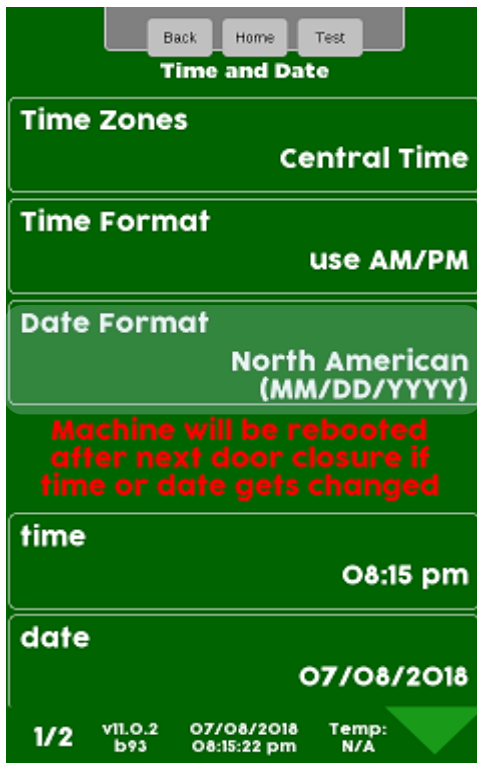



System Settings

Time and Date

Touch the Time menu bar to change the current time .

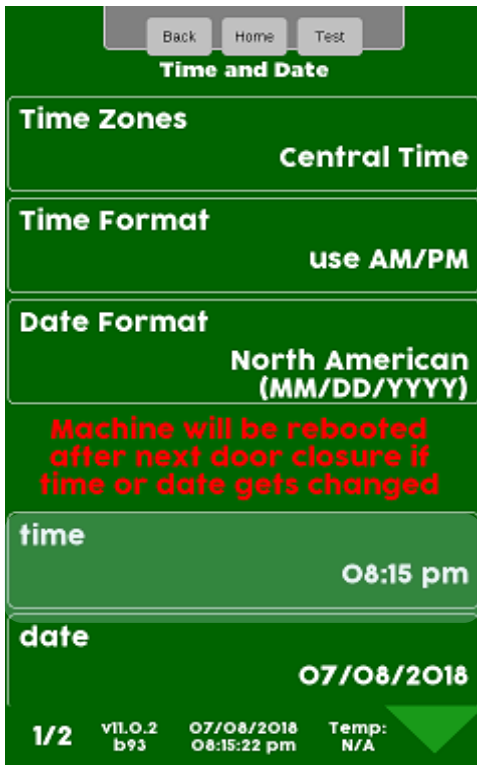

Use the keypad to enter in the hours and minutes to change the time. Touch Accept when finished.

Press the door switch after setting the time and/or date, this will cause a reboot and ensure the Time & Date are saved.

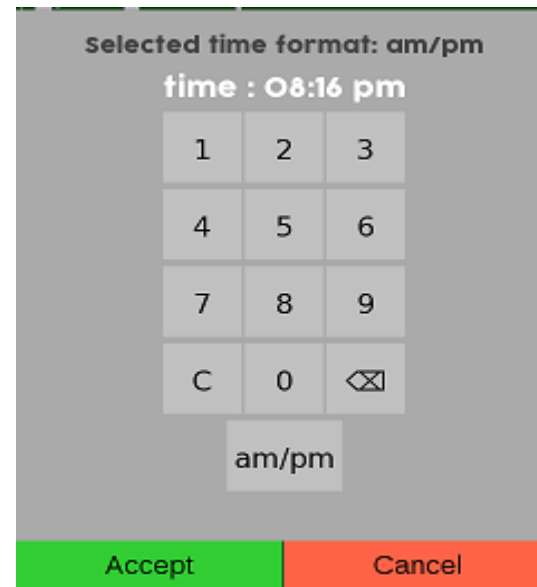



System Settings

Time and Date

Touch the Date menu bar to change the Current Date .

Back Home Test

Time and Date

Time Zones Central Time

Time Format use AM/PM

Date Format North American (MM/DD/YYYY)

Machine will be rebooted after next door closure if time or date gets changed

time 08:15 pm

date 07/08/2018

1/2 vii.O.2 b93 07/08/2018 08:15:22 pm Temp: N/A

Enter in the Day, Month and Year to change the date. Touch Done when finished.

Press the door switch after setting the time and/or date this will cause a reboot and ensure the Time & Date are saved.

date : 07/08/2018

1	2	3
4	5	6
7	8	9
C	0	<⊗

Accept Cancel



System Settings

Language

The Language Menu allows you to:

- Customize the Languages available to your customer.
- As shown in the picture to the right, you can enable multiple Languages at one time.
- The Language used in the service menus can also be changed and are independent of the customer languages set.
- Additional Languages can now be uploaded without changing the software, starting with version **XXX**.

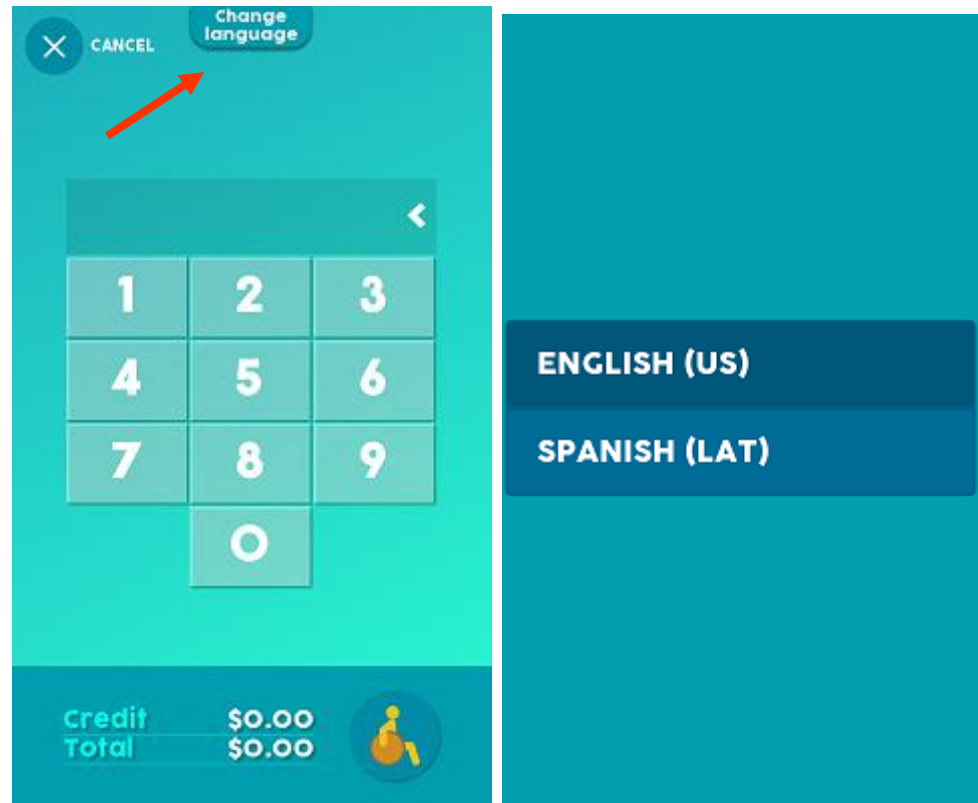



System Settings

Language

Touch Language to change the Language options.

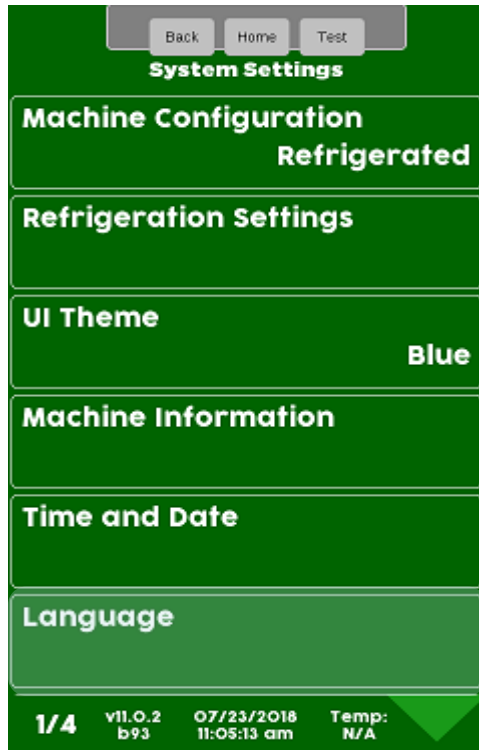

Touch Service Application or User Interface to change the current Language options.

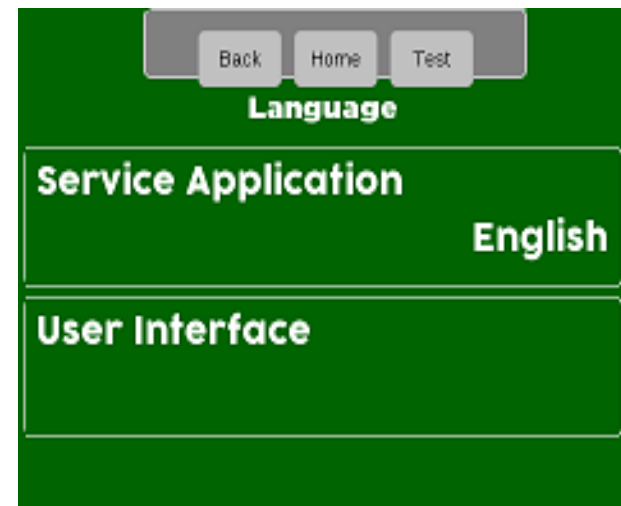



System Settings

Language

To change the Language used in the Service Menus Touch the Service Application menu bar.

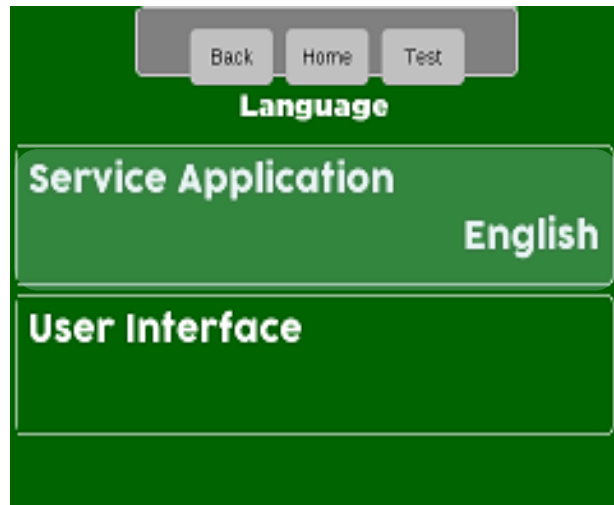

Touch a Language and Press Accept to apply that Language as a default for the Service Menus.

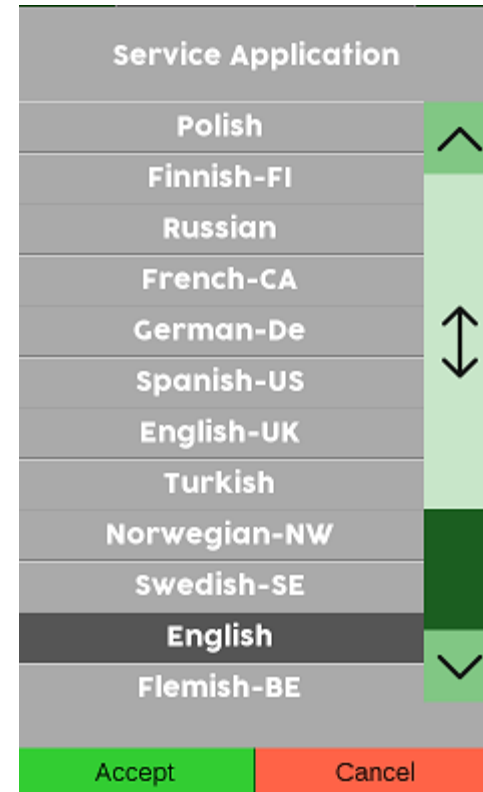



System Settings

Language

To change the Language used to communicate with the customer press the User Interface.

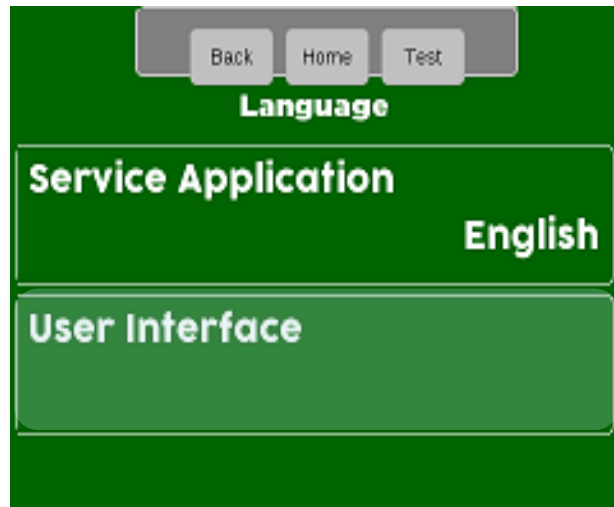

This menu allow you to choose which Languages are available to your customer as well as the default Language.

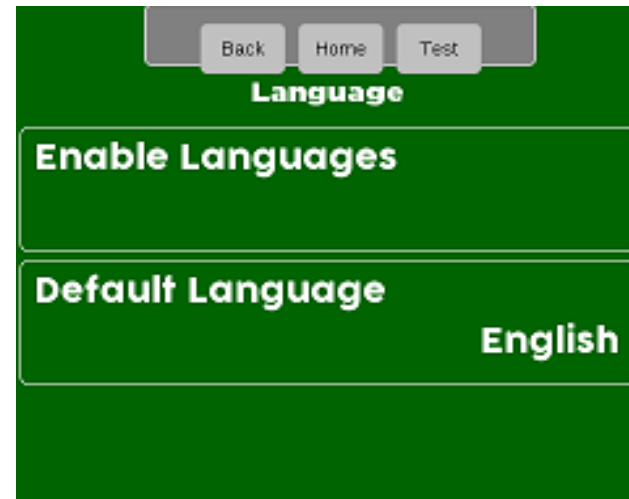



System Settings

Language

Choosing Enable Languages will bring up a list of Languages available to be used on the screen to communicate with your customer

Touch one or multiple menu bars to enable the Languages that will be available as an option for your customer to choose when using the machine. If there are multiple versions of the same language only one can be selected.

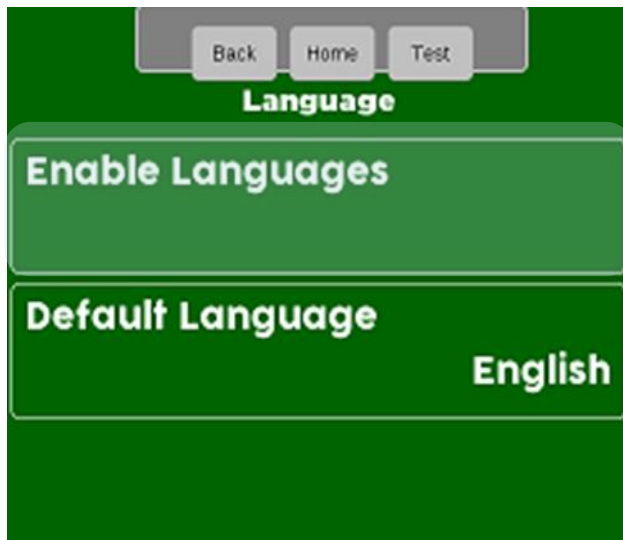



System Settings

Language

Choosing Default Language will bring up a list of Languages available to be used as a default Language

Choose a default Language for your Screen. Press Accept to change the current Default Language to the one selected. Once the idle screen message is touched during vending you will have an option to change to one of the enabled languages.

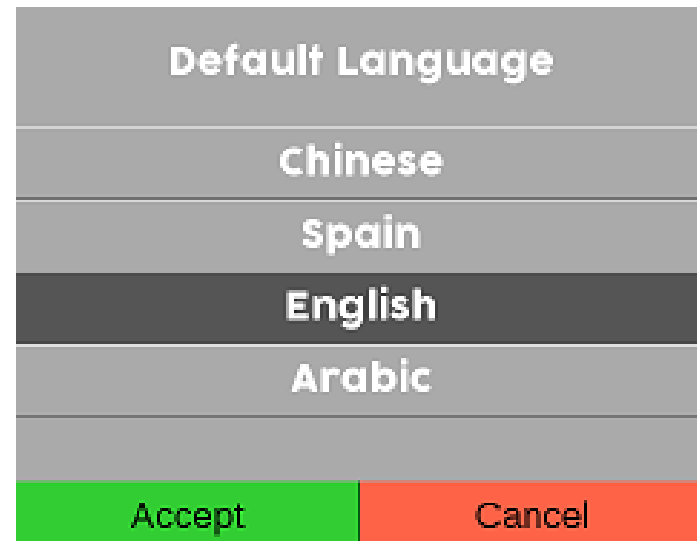



System Settings

Language

The screenshot below shows the consumer workflow of how to change the Language on the machine

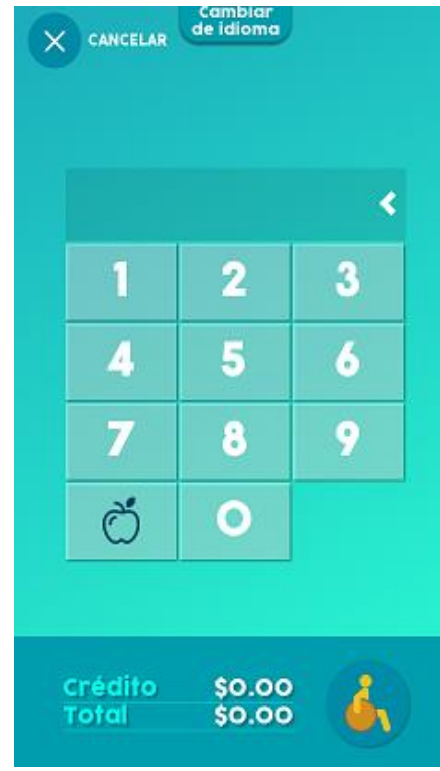
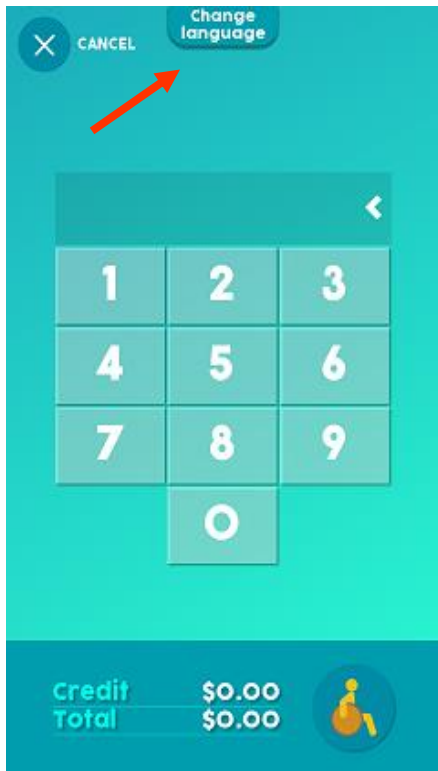



System Settings

Custom Messages

Custom Messages

- This menu gives the user the option to create and enable messages for both the Idle screen and the vending screen independently.
- These Messages can be mixed Text or Numeric characters.

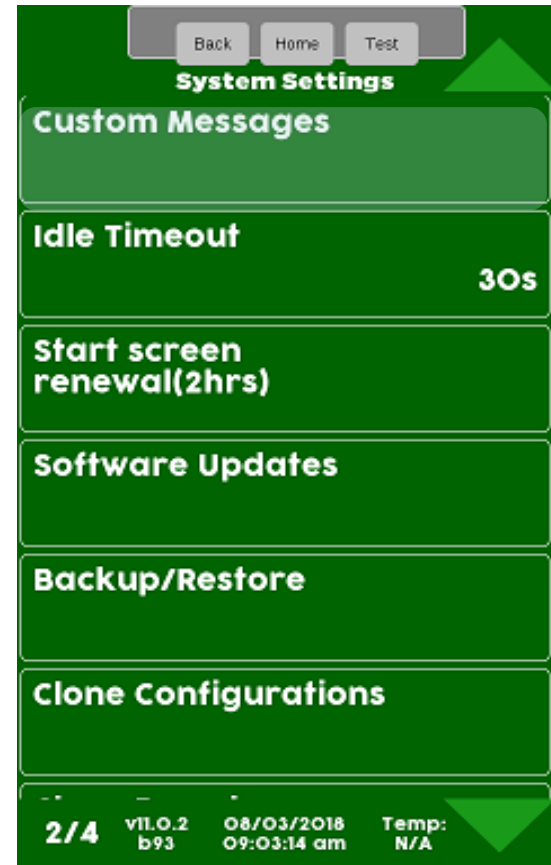



System Settings

Custom Messages

Touch the down arrow on the right side of the display to scroll down to Custom Messages.

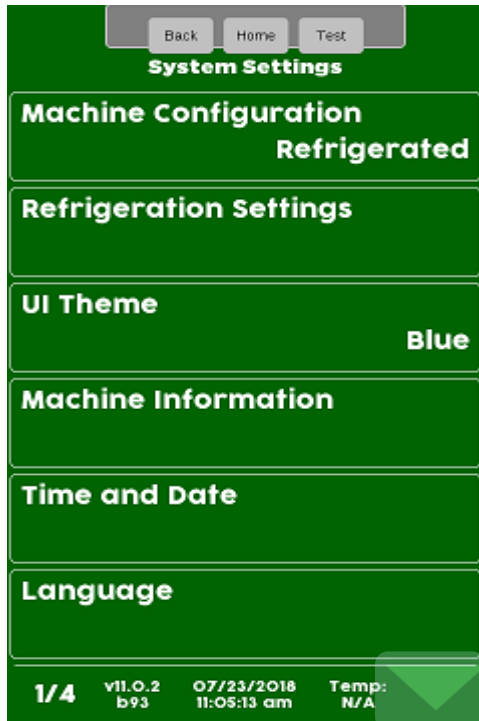

Touch Custom Message to create, change or assign a Custom Message

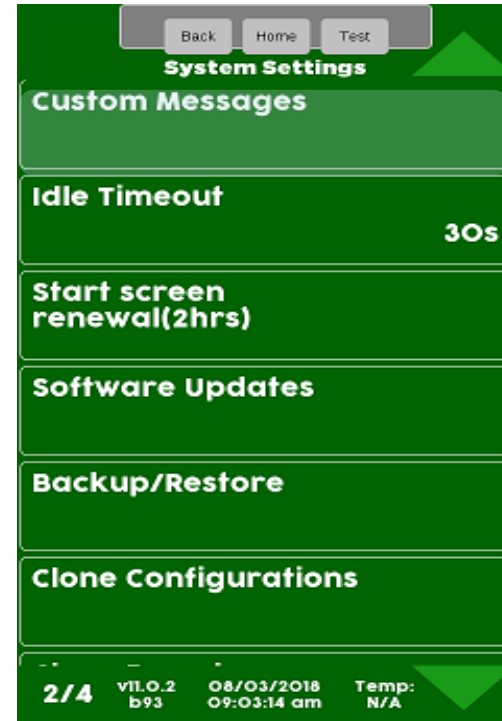



System Settings

Custom Messages

Touch a menu bar to add a checkmark to enable a Custom message. Adding a checkmark will automatically bring up the next screen

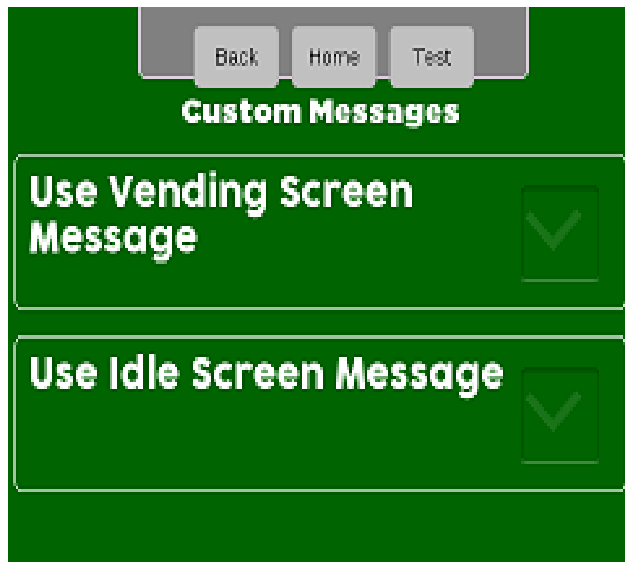



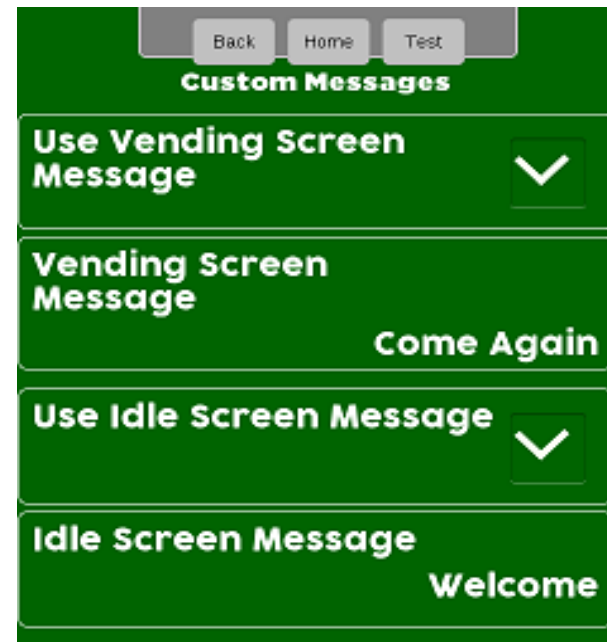

Touch the Vending Screen Message or Idle Screen Message menu bar to create your Custom Message.



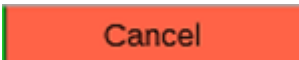

System Settings

Custom Messages

- A keypad will appear on the screen along with a window to enter the Vending Screen Message.
- Use the keypad to enter the information.
- Touch Accept when finished
-  is your backspace key.
-  you to exit without changes.
-  switches the keypad to numeric.
-  switches the keypad to uppercase
-  switches to lowercase
-  switches the keypad to symbols and numbers.





System Settings

Idle Timeout

Idle Timeout

- If a person starts a transaction on the machine and walks away without pressing the **Cancel** icon, the idle timeout is the amount of time until the machine goes back to its standby message routine.
- The Idle Timeout is settable from 1 to 3600 seconds.
- The factory default for the Idle Timeout is 30 seconds.
- Touch Idle Timeout and a Screen will pop up allowing you to change the Timeout period.
- Press Accept to save the new time entered.





System Settings

Start Screen Renewal

Screen Renewal

- The Screen Renewal Menu Item allow you to refresh the screen if it has is blurry or has become burned or are seeing image retention from one screen to another.
- One this menu is enabled the screen will go white for 2 hours and prompt Screen renewal in progress, at the end of 2 hours the machine will go back to the normal Idle Screen Messages.
- If you need to interrupt the Screen Renewal process once it has started turn the power switch on the machine off an back on.

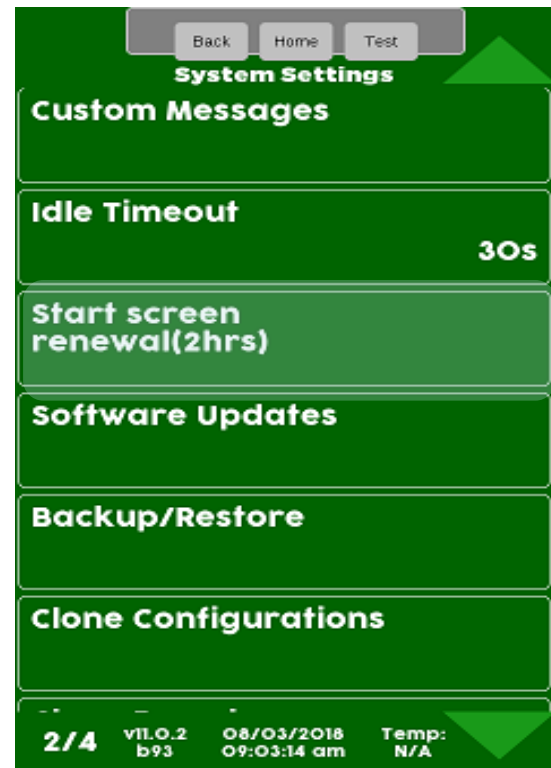



System Settings

Software Updates

Software Updates

- The Software updates menu provides a means to load firmware updates and other files into the machine.
- This menu is used to load new firmware versions if the file type is XXXXX.itb. If the file type is XXXXX.CJFFS2 the file will automatically load if the USB is installed when the machine is powered up.
- There are numerous files that can be updated through this menu, some of the most common are:
 - **Plan-o-gram files**
 - **Custom Library files**
 - **Advertisements**
- The example of the following page shows a Plano-gram file being loaded but all other update files are loaded the same way.

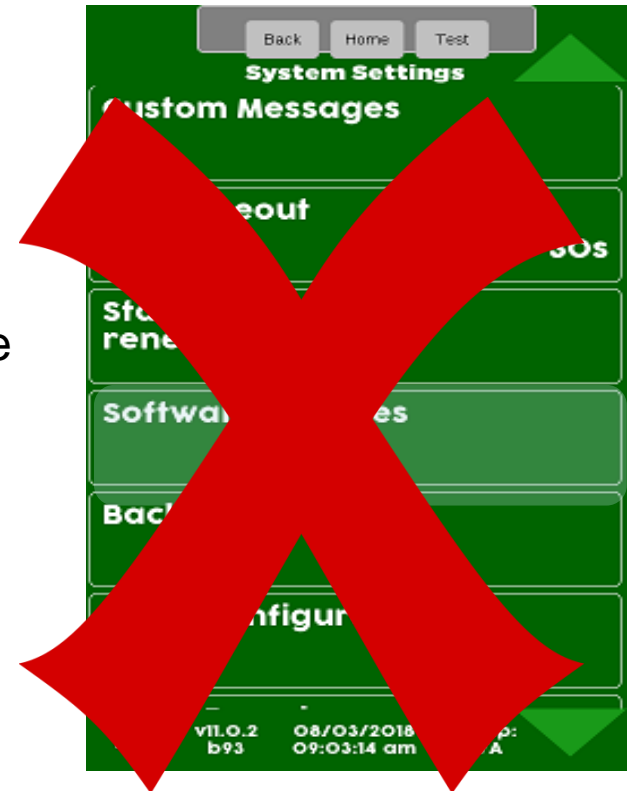



System Settings

Backup / Restore

Backup / Restore

- Allows you to backup your current Configuration for recovery later if needed.
- Allows you to restore the machine to factory defaults.
- Allows you to restore the machine to a previously saved configuration
- Backups are saved with date created.
- Backups are stored on the controller, not removable media.

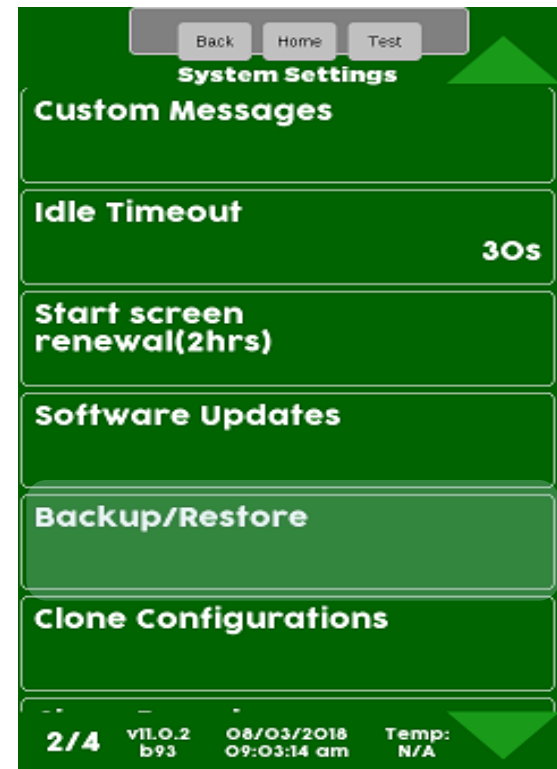



System Settings

Backup / Restore

If you choose Restore Factory Defaults, a conformation screen will appear. Choose Yes to continue or No to cancel.

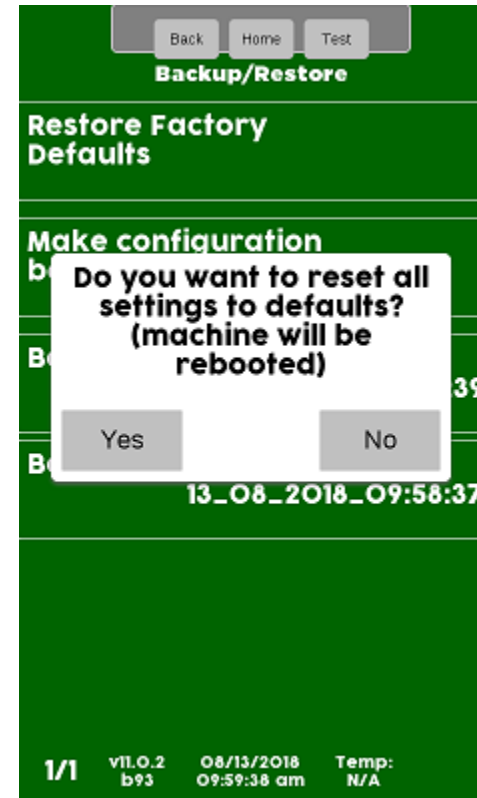
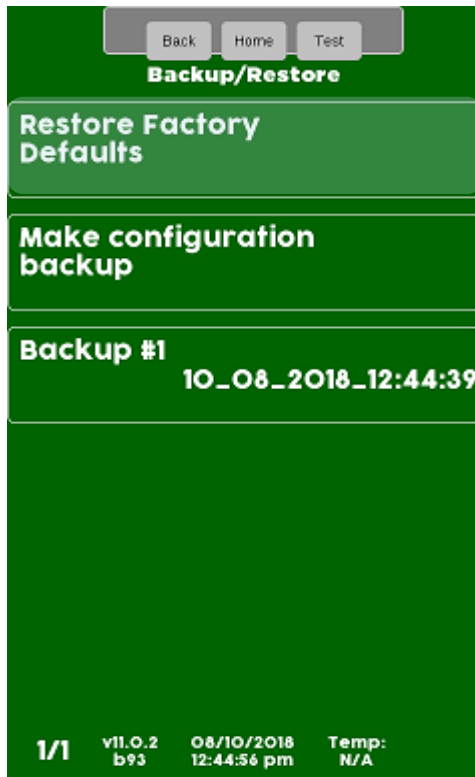



System Settings

Backup / Restore

Touch Make New Backup to backup your current configuration for recovery later. All previous backups will be listed. You can select any backup you want to restore.

In this case we are choosing make a new backup and it immediately creates a backup that can be installed from this menu at a later date

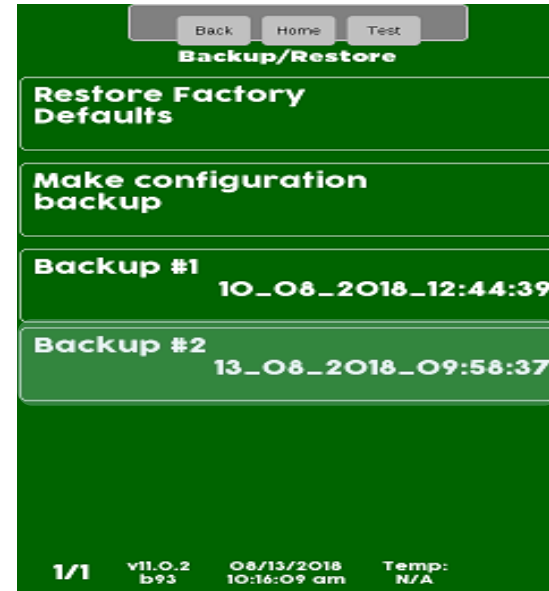
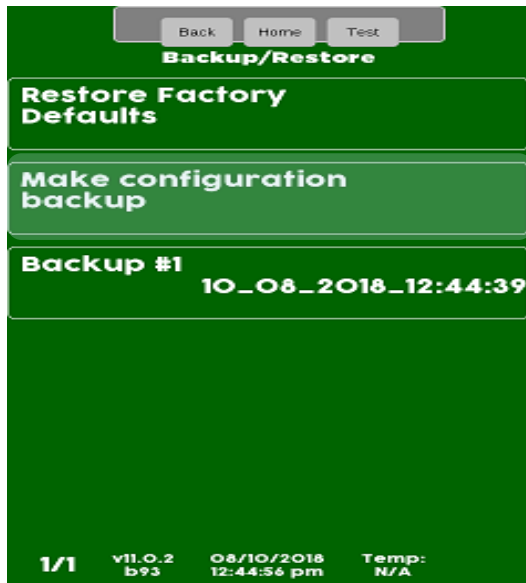



System Settings

Clone Configurations / Clone Board

Clone an Existing Configuration or Board

- This menu allows you to copy a machine that has been previously been set up and save that file on a flash drive.
- The difference between Clone Configurations and Clone Board menu is that clone board also copies the meter readings, this allow you to change a board or update software and keep the same meter readings.
- Once you have copied an existing configuration (set up) you can load it into other machines.
- For ease of use in the future the files can be named.
- You can have unlimited clone files in the atlas folder.

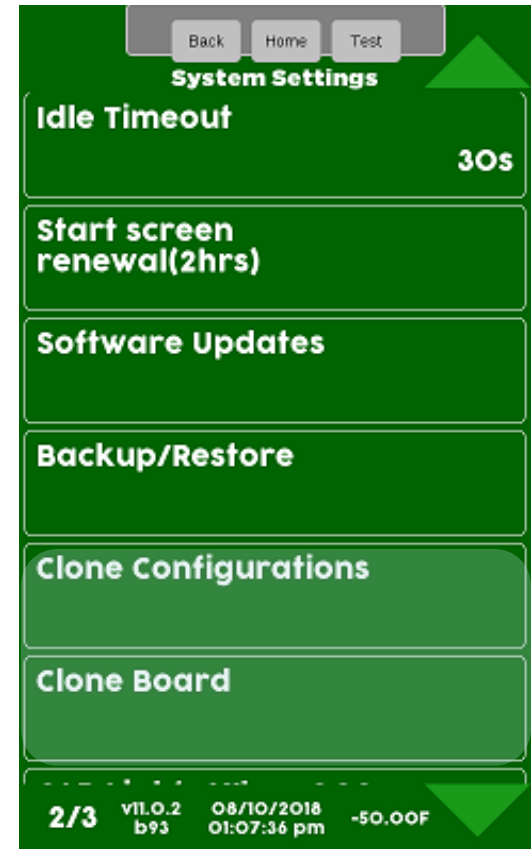



System Settings

Clone Configurations / Clone Board

Preparing the Flash drive

- Before attempting to clone an existing machine configuration you must create a folder on your USB flash drive named atlas (lower case is important).
1. Insert the flash drive into an available USB port on the control board, typically USB3
 2. Enter PIN 3333
 3. Touch System Settings, then Clone configuration or Clone Board.

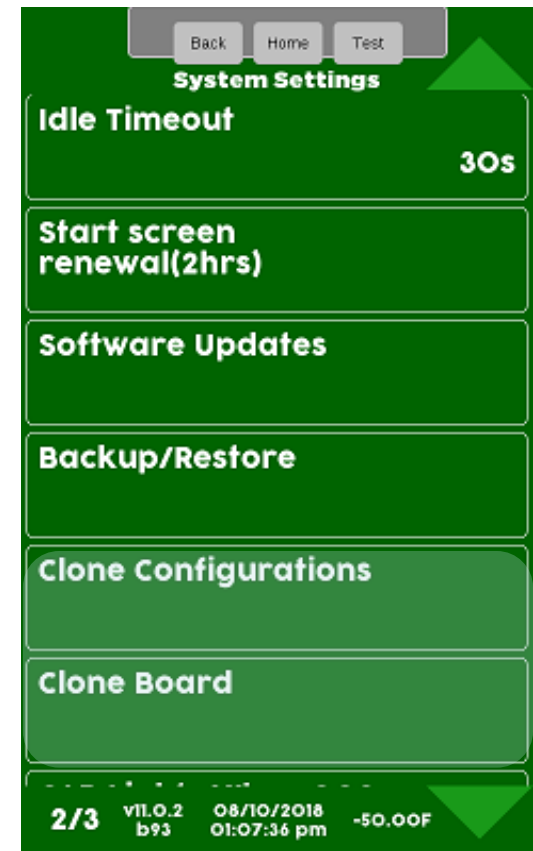



System Settings

Copy Configuration

Touch Create a Clone, Touch Create Clone on USB drive

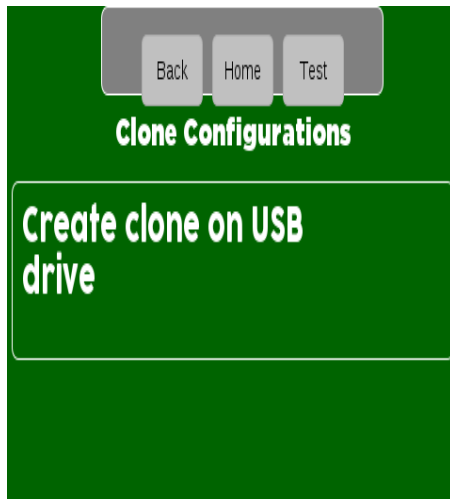

If you wish to name your clone so you can easily identify it on the USB choose Clone Name

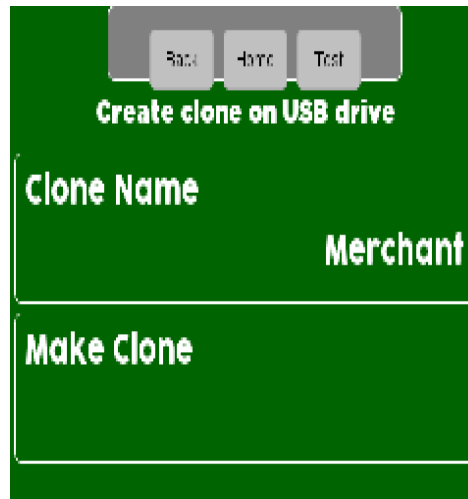

Enter a Clone Name and press Accept.





System Settings

Copy Configuration

Touch the Make Clone menu bar to create a clone on the USB

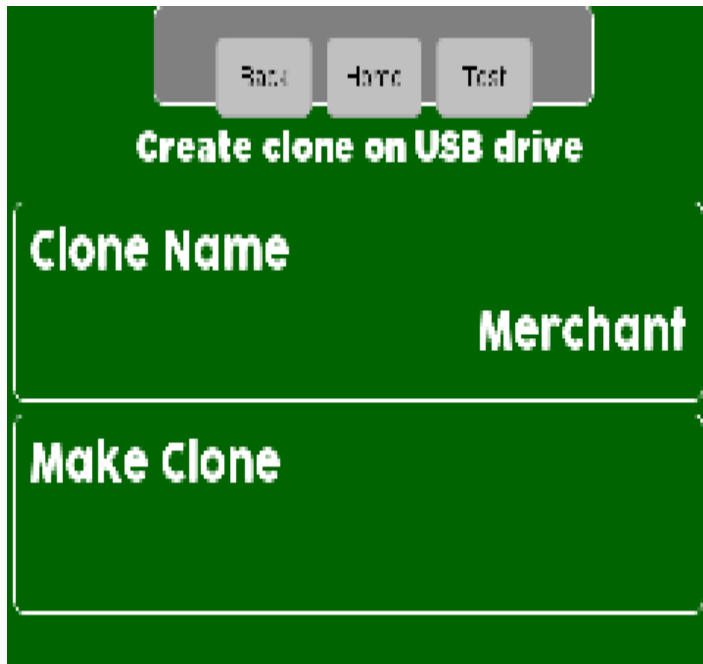

A conformation box will appear, Touch Yes to continue or No to cancel





System Settings

Clone Configuration – Uploading or removing a Clone

Choose Install Clone or remove or delete a clone from the flash drive

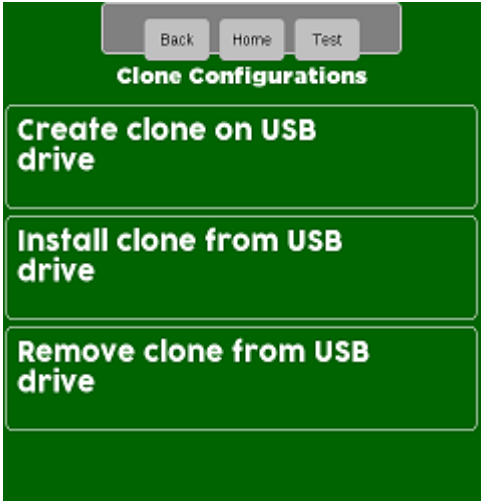

The display will show the available clones that can be copied or deleted from the flash drive. Touch a Clone File to upload or delete.

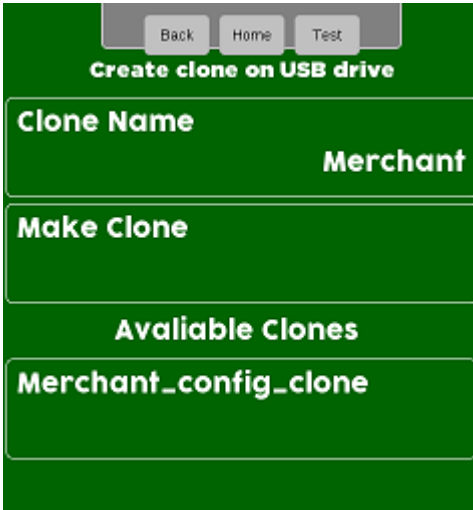

A confirmation box will appear verifying you want to install or remove the file, Touch Yes to continue or No cancel.





System Settings

Cab Lights When OOS

Cabinet Lights when out of Service.

- This Menu allow you to choose if you want the cabinets light to stay on or turn off when the machine is out of service.
- Touch CAB Lights When OOS to toggle between Yes and NO. Choosing Yes will cause the cabinet lights to turn off anytime the machine is out of Service.





System Settings

Advertisements

Advertisements

This menu allows the user to turn on and off messages that are shown to the consumer during the idle screen loop and during the vending process.

- Advertisements can be updated from the server or via a USB.
- There is an extensive list of preprogrammed advertisements and promotions that can be selected.
- Custom advertisements can be loaded and enabled.

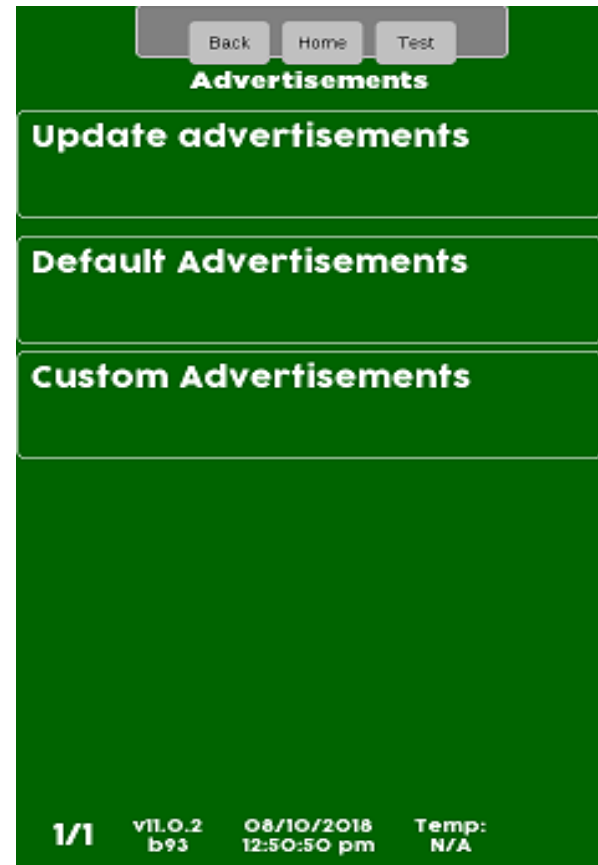



System Settings

Advertisements

To update Advertisements touch the Update advertisements menu bar



You have the option to select updating from a USB device with an atlas folder that has advertisements on it or if online with Crane you can update from the server.

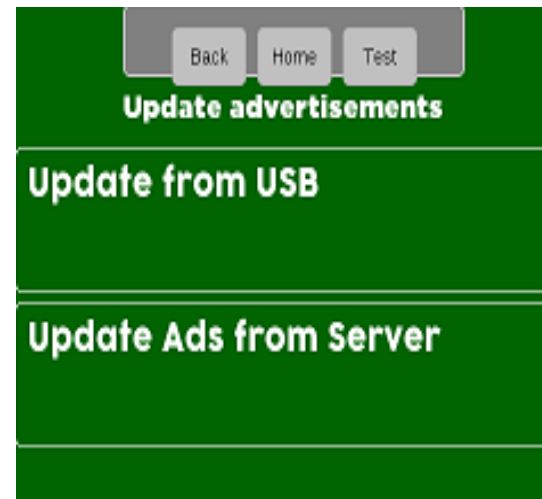



System Settings

Advertisements

The default Advertisements Menu contains all the Default and pre loaded Advertisements.

- On power up the machine will find the coin mechanism and bill acceptor, enable them, and turn on those advertisements.
- The Advertisements will show the values of bills being accepted including \$1 coins.
- Attaching an MDB card reader or enabling an Onboard Reader will enable the Monetary Card Advertisements
- All Custom Promotions and Combo Vend Advertisements must be enabled when you set up the promotion in their respective menus.

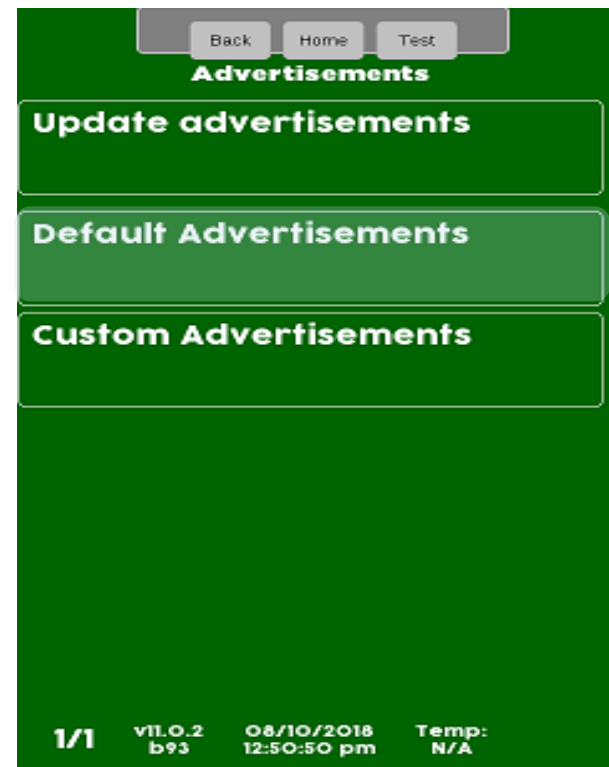



System Settings

Advertisements

The default Advertisements Menu contains the following advertisements that can be turned off and on. Choosing any of the menu bars will bring up an on off toggle.

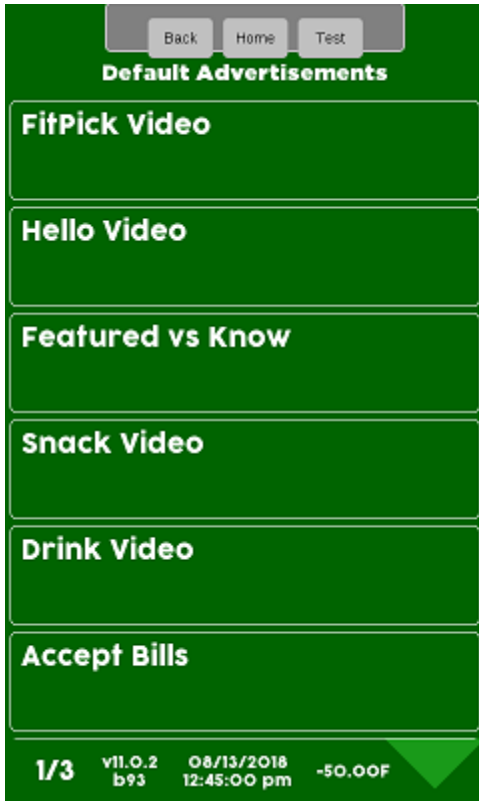



System Settings

Advertisements

Choose Credit Card Types Accepted to enable/disable card messages.

Touch a card type to add or remove a checkmark. Items with a checkmark will be shown on the Idle Screen Loop. Selecting ID will show a generic picture of a credit card in the idle loop.

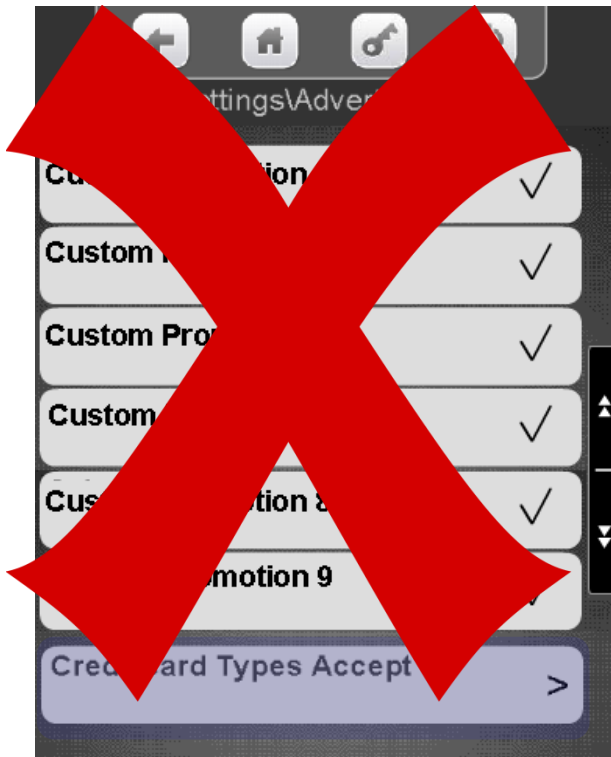



System Settings

Advertisements

The Custom Advertisements Menu contains all the customer loaded custom Advertisements.

Press Custom Advertisements to show a list of custom advertisements available

Touch the advertisement menu bar to add a checkmark to enable or remove a checkmark to disable the custom advertisement.

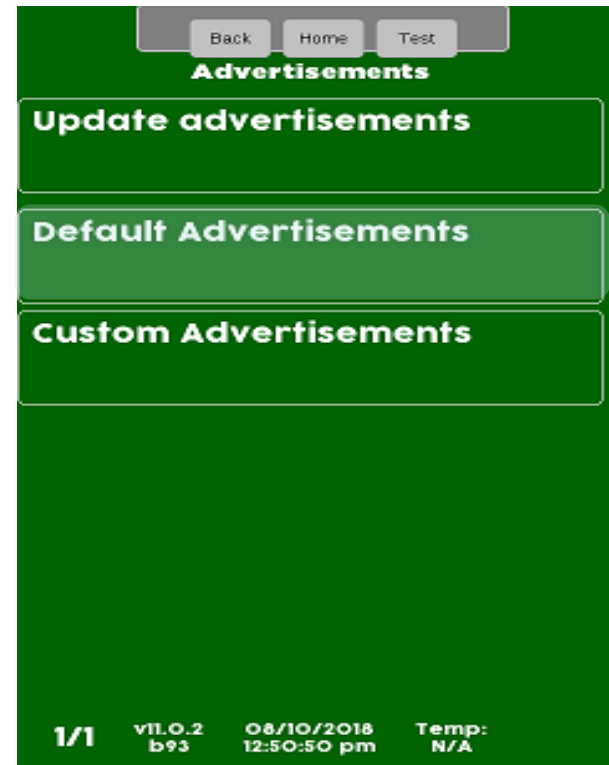



System Settings

Data Transfer Standard “DTS”

Data Transfer Standard (DTS)

- This Menu allows you to change what data is sent and control what data is reset on a DEX or DDCMP transfer.
- The defaults for these menus are the standard settings and are typically not changed.
- Before making changes you may want to contact your DEX provider or your Manufacturer Representative.

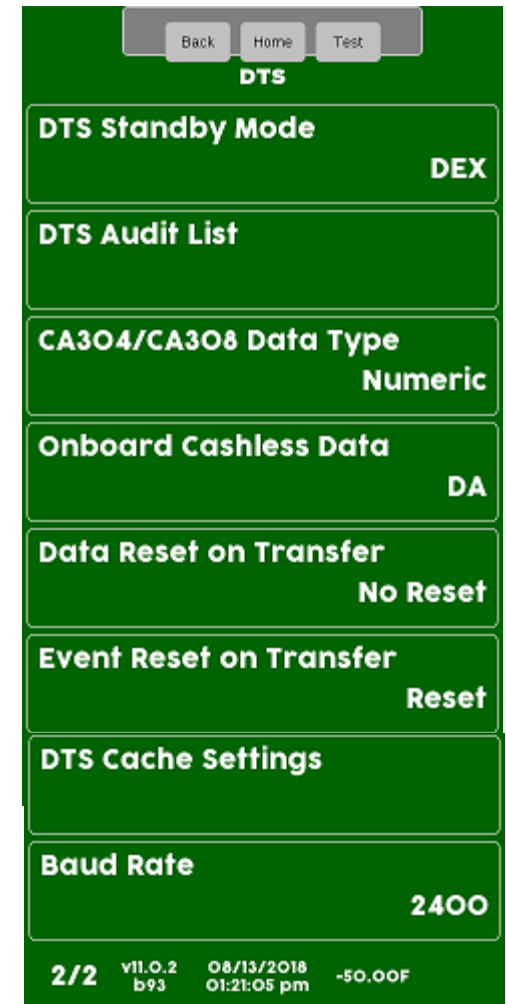
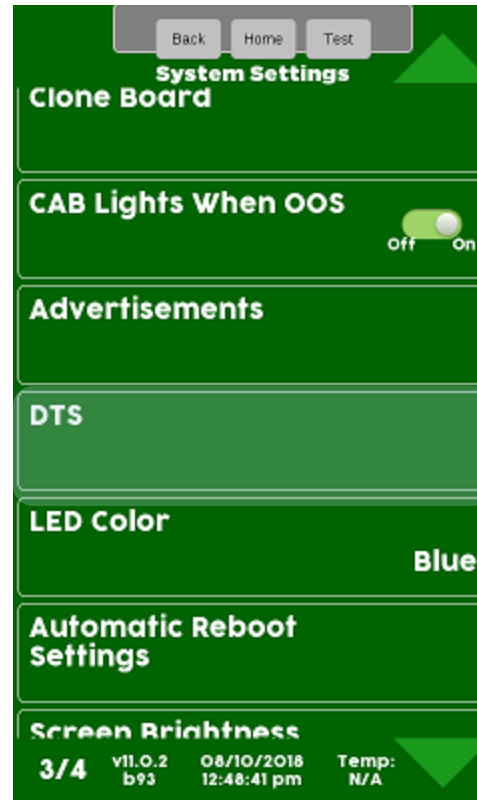



System Settings

Data Transfer Standard "DTS"

DTS Standby mode to change the transfer type.

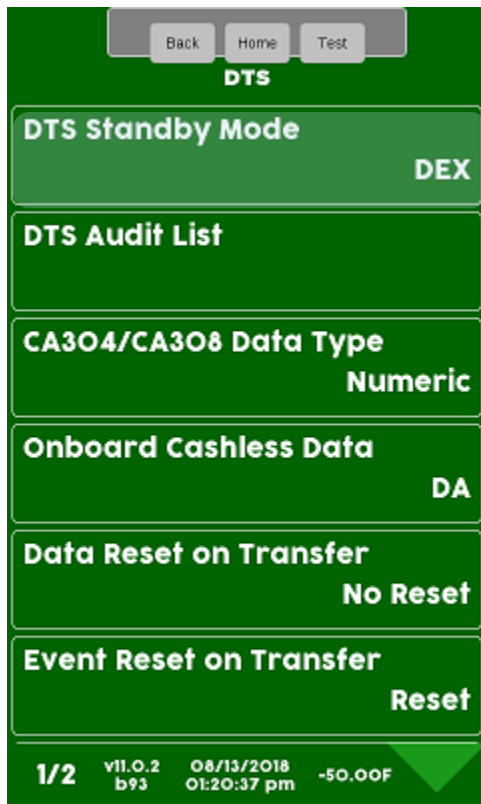

Touch DDCMP or Dex on the menu bar to change the transfer type. Touch Accept to save.

Note: In the US you will always choose DEX

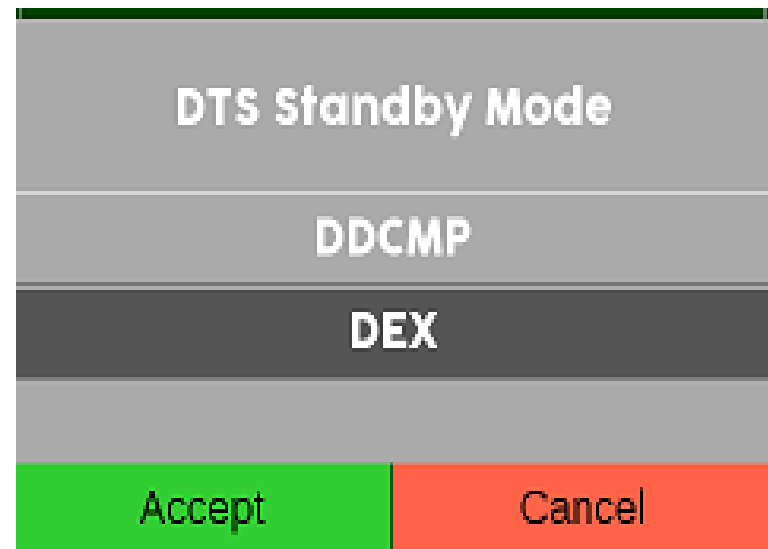



System Settings

Data Transfer Standard "DTS"

To Modify the Audit List
Touch DTS Audit List.

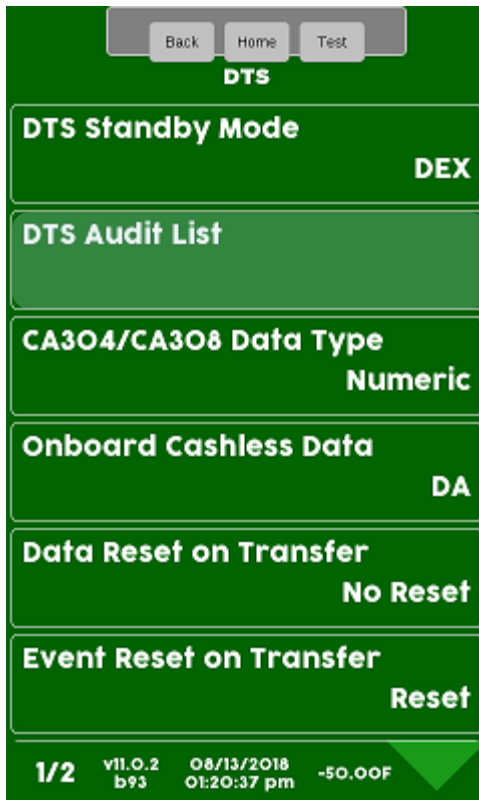

Touch a menu bar to add or remove items from the audit list. This menu gives you the ability to shorten the DEX file. Do not remove items without contacting your DEX provider or your Manufacturer Representative. Touch the down arrow on the right to scroll through the Audit List

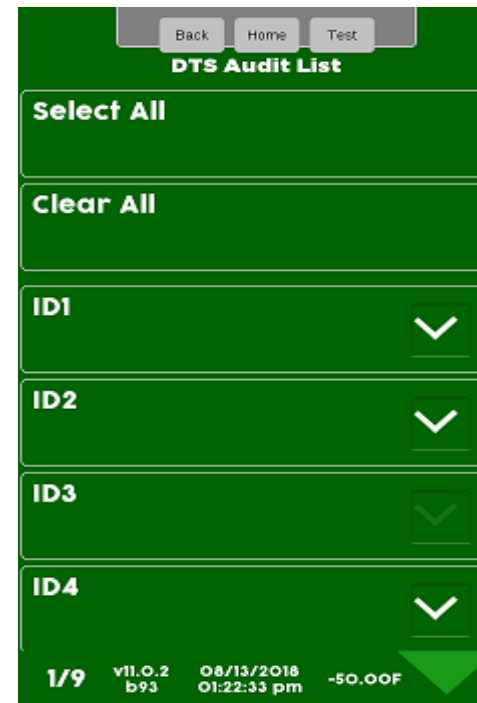



System Settings

Data Transfer Standard "DTS"

Touch CA304 Data Type to change how bills are reported.

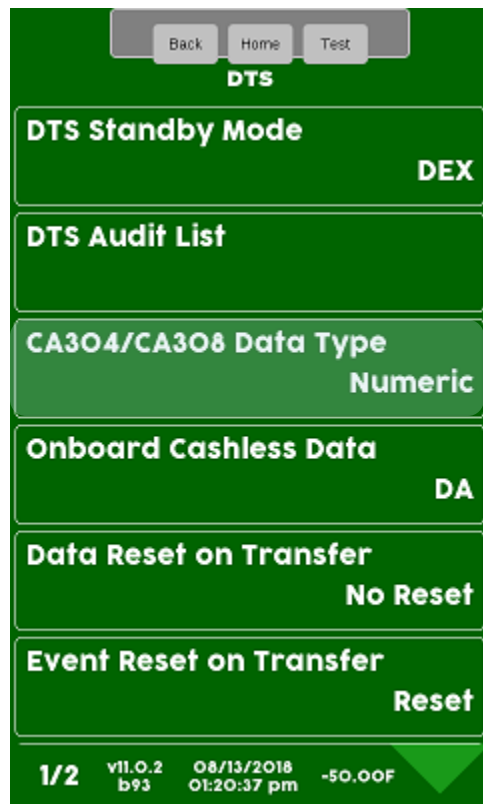

Touch Currency or Numeric on the screen to change how bills are reported. Touch Accept to save.

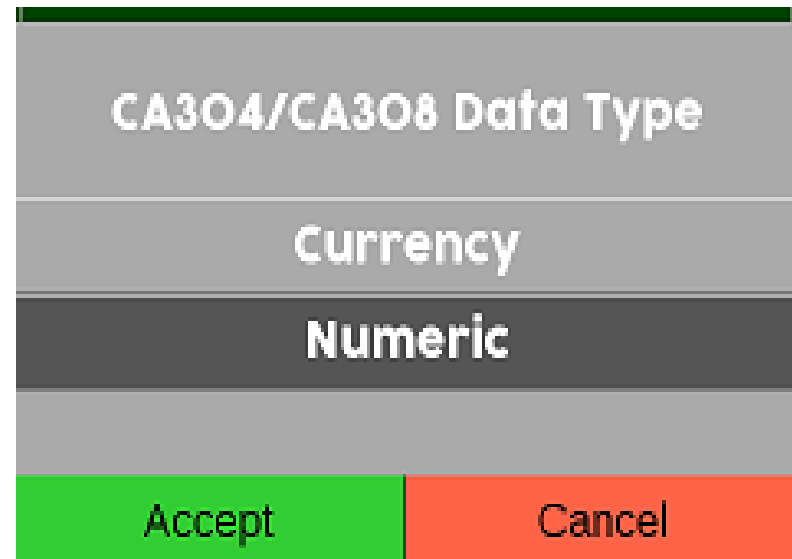



System Settings

Data Transfer Standard "DTS"

Touch Onboard Cashless Data to change how the Data field is reported.

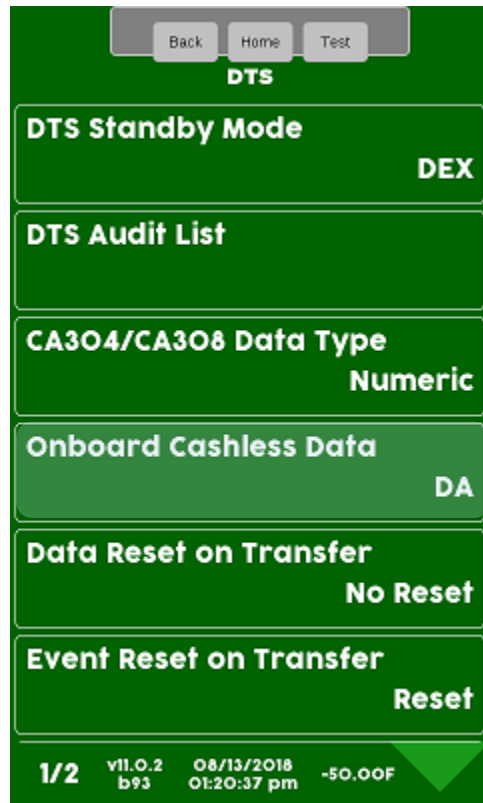

Touch Currency or Numeric on the screen to change how bills are reported. Touch Accept to save.

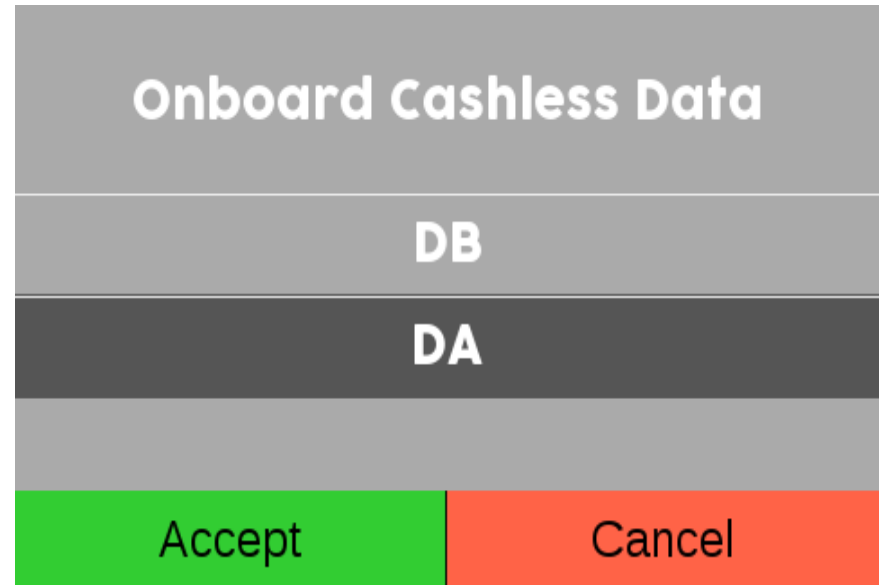



System Settings

Data Transfer Standard “DTS”

Touch the Data Reset Menu bar to change preference

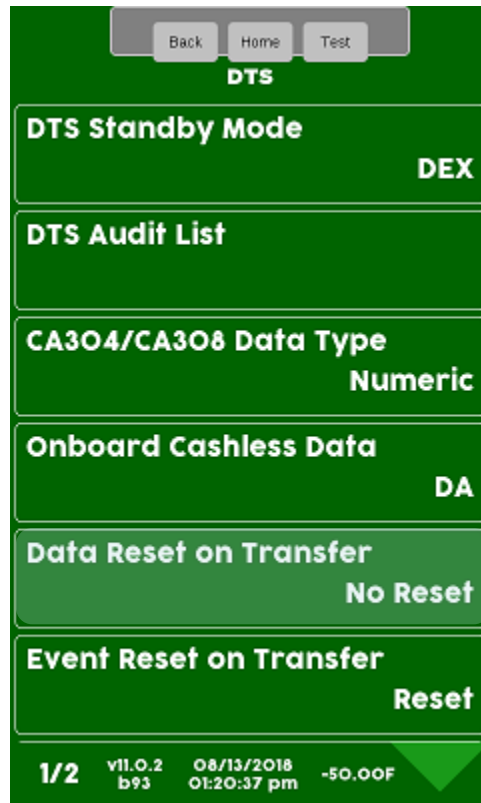

Touch Reset or No Reset. Touch Accept to save.

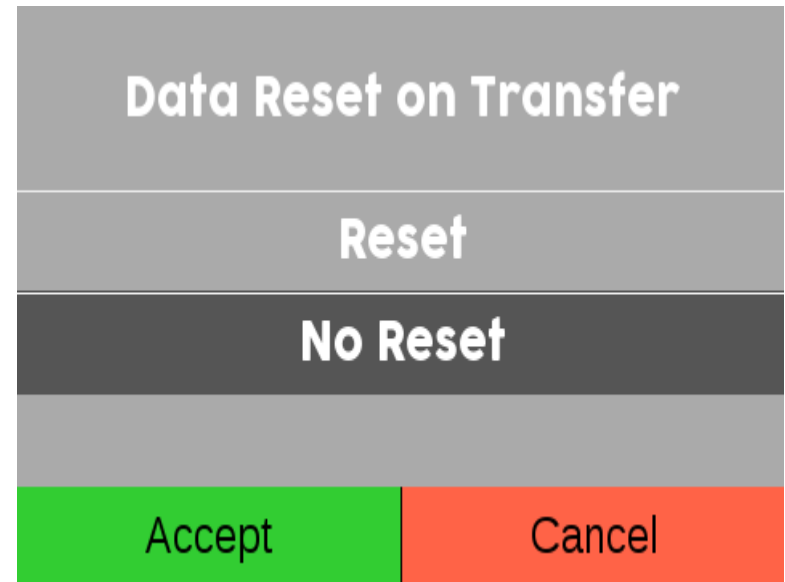

Recommended Setting: Data Reset should be set to Reset. Setting this option to No will result in the size of the DEX file increasing over time to unmanageable levels



System Settings

Data Transfer Standard “DTS”

Touch the Event Reset Menu bar to access the menu.

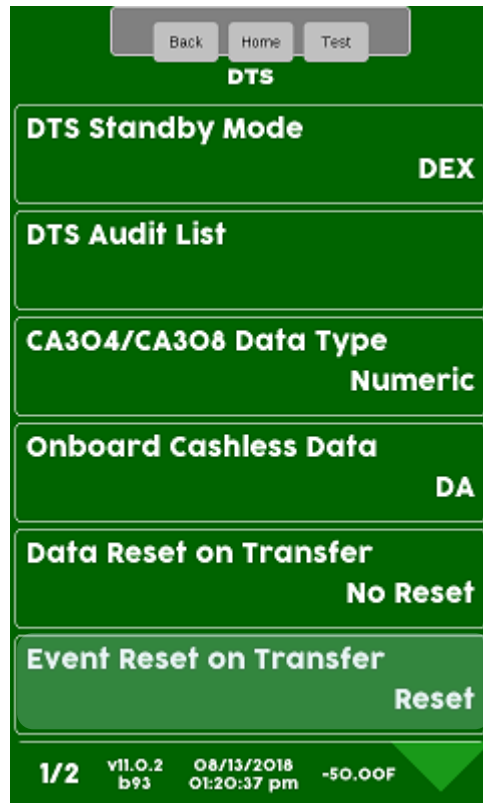

Select Reset or No Reset.
Touch Accept to save.



Recommended Setting: Event Reset should be set to Reset. Setting this option to No will result in the size of the DEX file increasing over time to unmanageable levels



System Settings

Data Transfer Standard "DTS"

Touch the DTS Cache Settings Menu bar to access the menu.

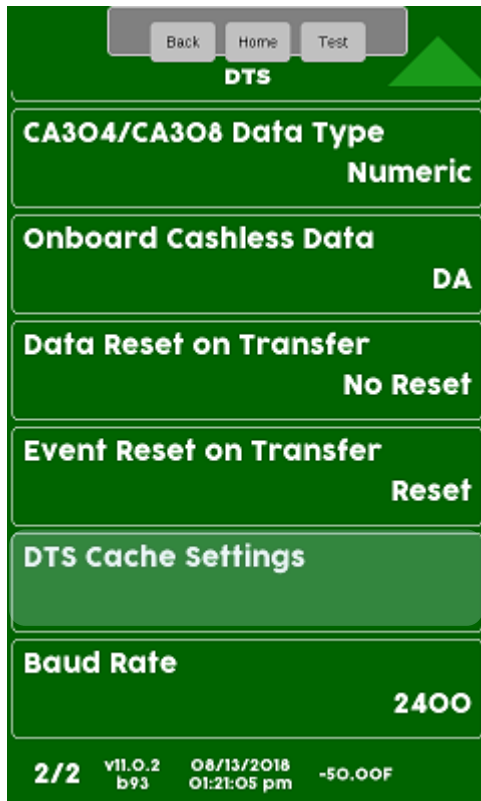

This setting enables or disables the ability of the Atlas board to prepare a new DEX file every 5 minutes and have it available on demand for quicker DEX reads required for non-Crane telemetry devices.

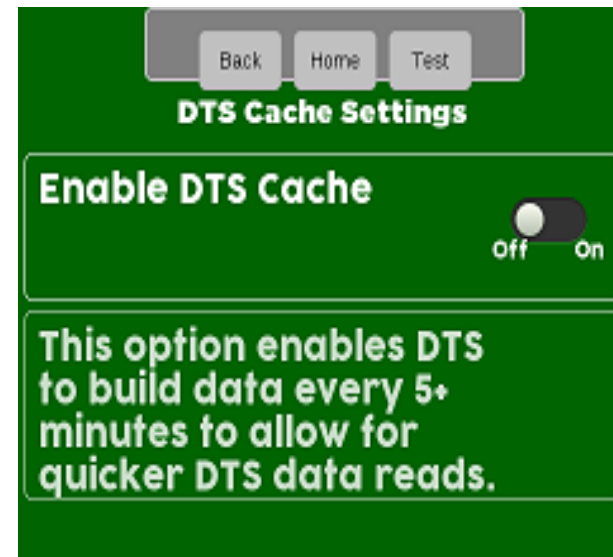



System Settings

Data Transfer Standard “DTS”

Touch the Baud Rate Menu bar to access the menu.

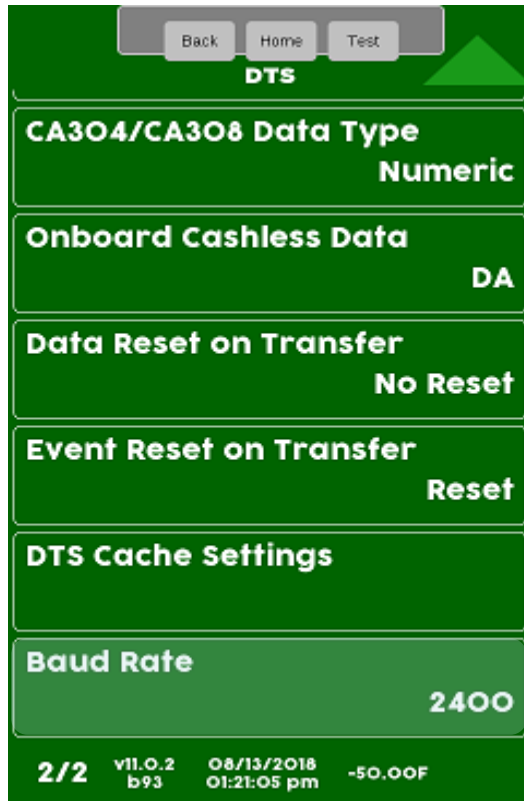

Choose the baud rate desired and press Accept to save. The default is 2400.

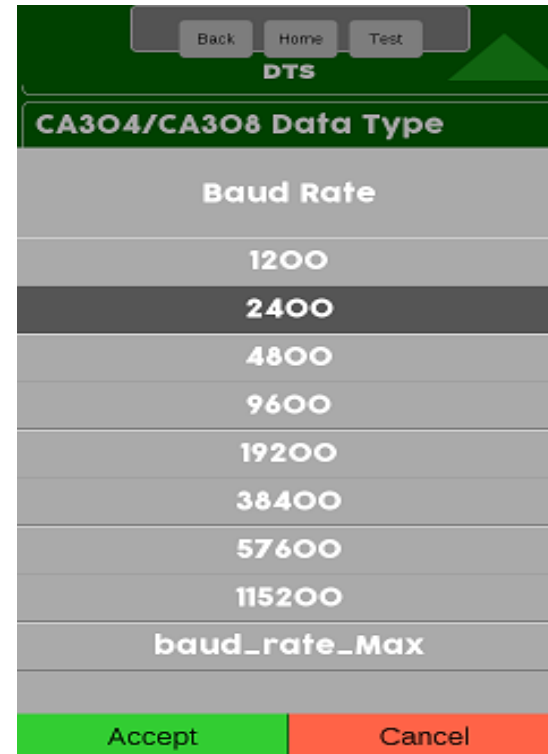



System Settings

LED Color

Touch LED Color to change the color of the pill surround and onboard payment devices.

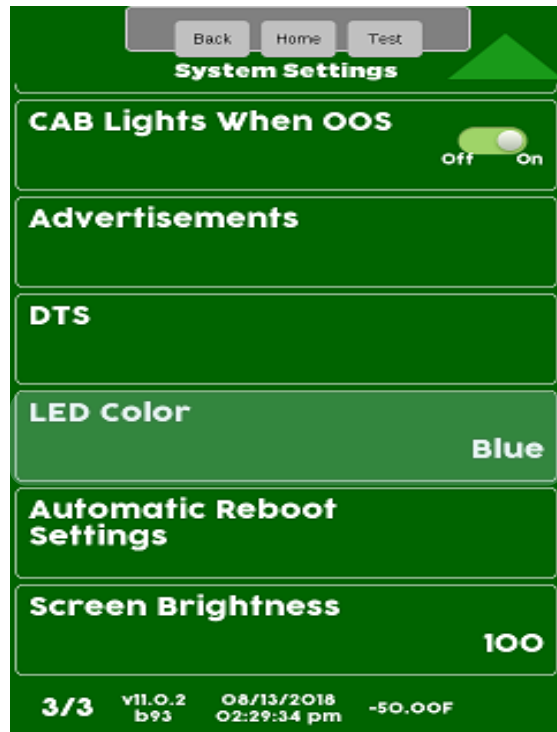

Use the arrow keys to scroll through the color options. HB=Heart Beat, FP = Fast Pulse or solid colors. Touch a menu bar to select and Accept to save.

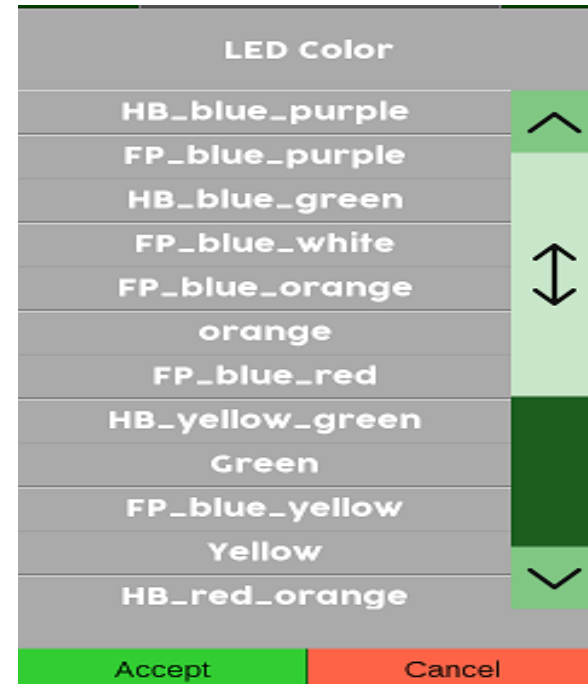



System Settings

Automatic Reboot Settings

Automatic Reboot Settings

- As a default the machine is set to reboot itself every evening at 2:00 am local time.
- This menu allows you to turn off or change the parameter of the nightly reboot.
- If your machine is equipped with cashless, this setting must be left on the default setting.
- If you find this setting interferes with customer activity, contact the Cashless team to make adjustments to this setting.

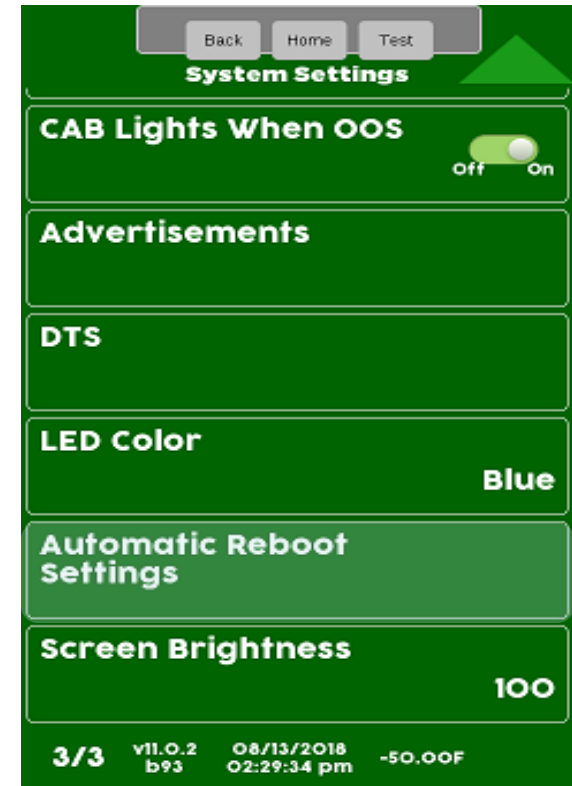



System Settings

Automatic Reboot Settings

Touch Automatic Reboot settings to enter the menu.

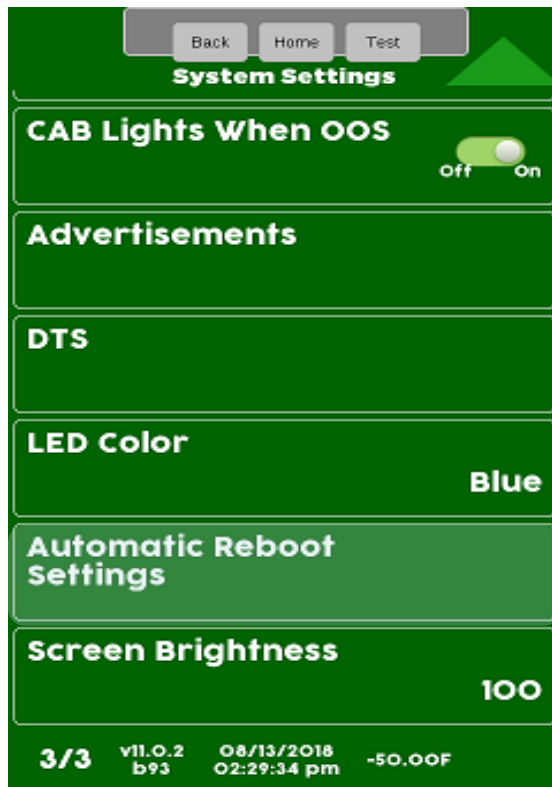

Touch Enable Automatic Reboot to toggle between Yes and No. **Any changes will cause the machine to reboot on door closure.**

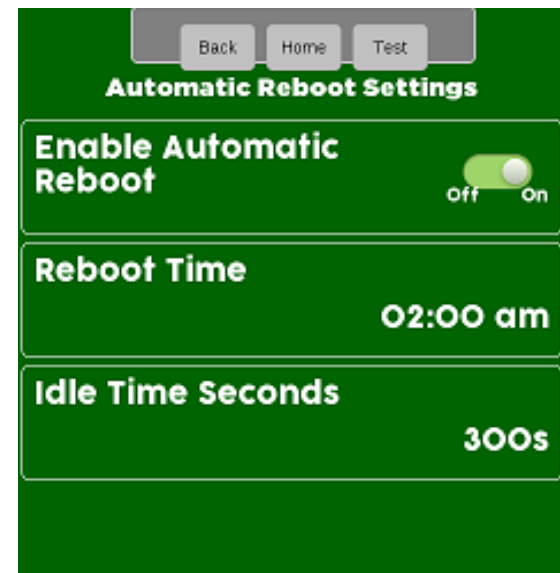



System Settings

Nightly Reboot Setting

Touch Reboot time and a keypad will appear. Use the numeric keypad to change the Reboot time. Press Accept when finished.

The idle time is how long since the machine has been used before the reboot will occur. Use the keypad to enter a new time in seconds. Press Accept when finished.

selected time format: am/pm
Reboot Time : 02:00 am

1	2	3
4	5	6
7	8	9
C	0	⊗

am/pm

Accept Cancel

Idle Time Seconds (0s-600s):
300s

1	2	3
4	5	6
7	8	9
C	0	⊗

Accept Cancel



System Settings

Screen Brightness

Touch Screen Brightness

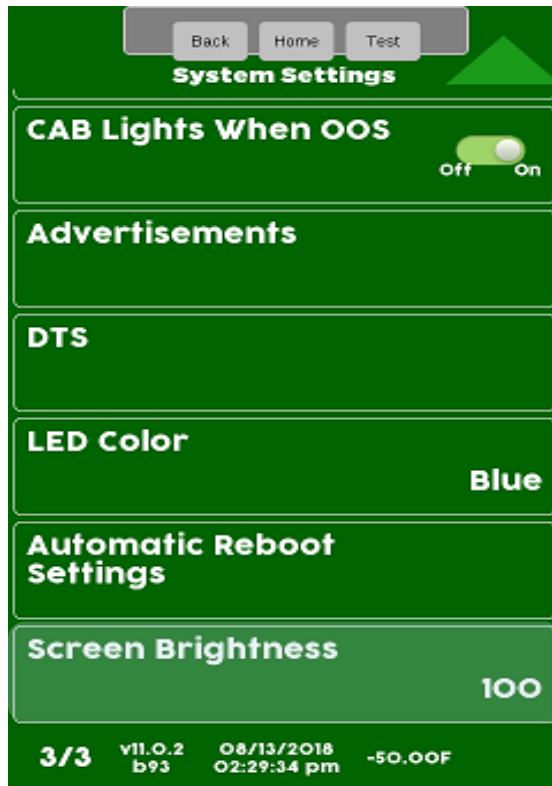

Use the numeric keypad to change the Brightness, the higher the number the brighter the screen. 100 is the default and as bright as it gets. Touch Accept to save.



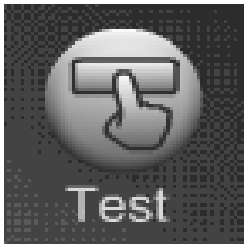

Test Menu

Test Menu

- Touch the Test Icon from the main menu to access the Test Menu.
- Touch any of the menu items listed on the Test Screen to access the test menu for that item.
- Touch the down arrow to the right side of the screen to scroll down to the additional menu items capable of being tested.

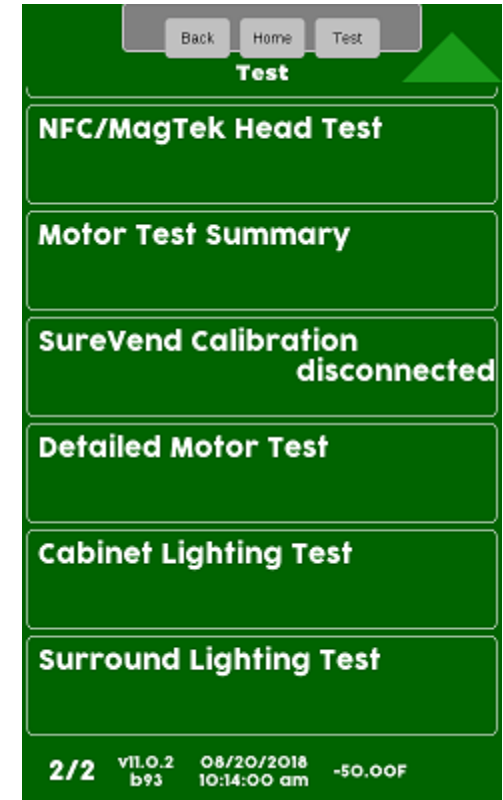
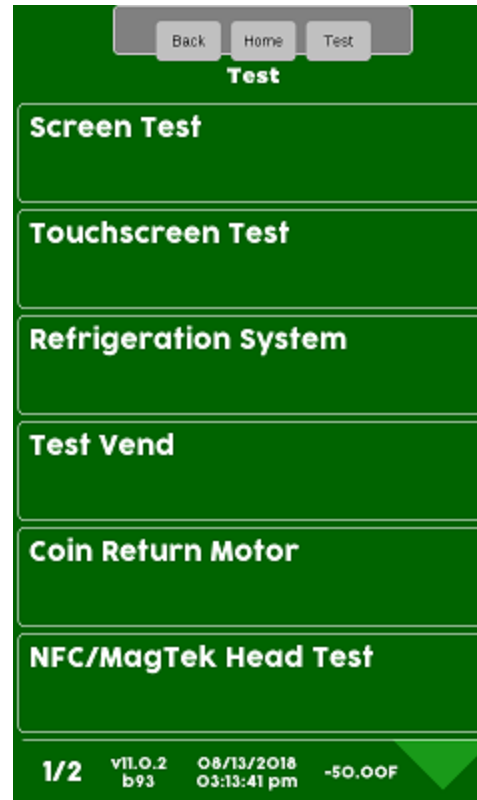

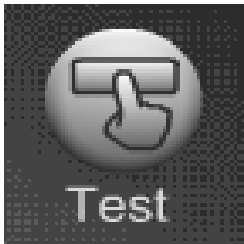

Test Menu

Screen Test

Touch Screen Test

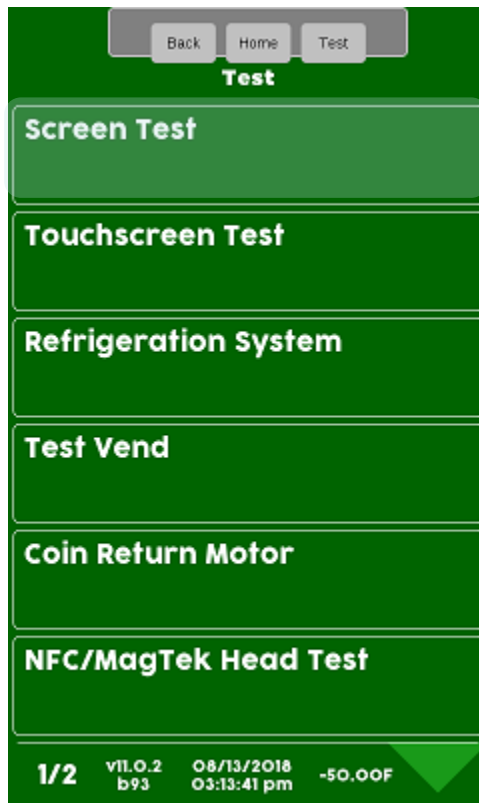

The display will illuminate with White, Yellow, Red, Green & Blue then Purple.

Touch the screen to Exit.



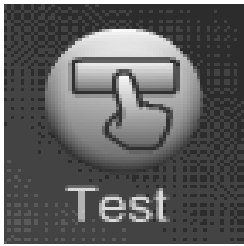

Test Menu

Touchscreen Test

Touch Screen Test

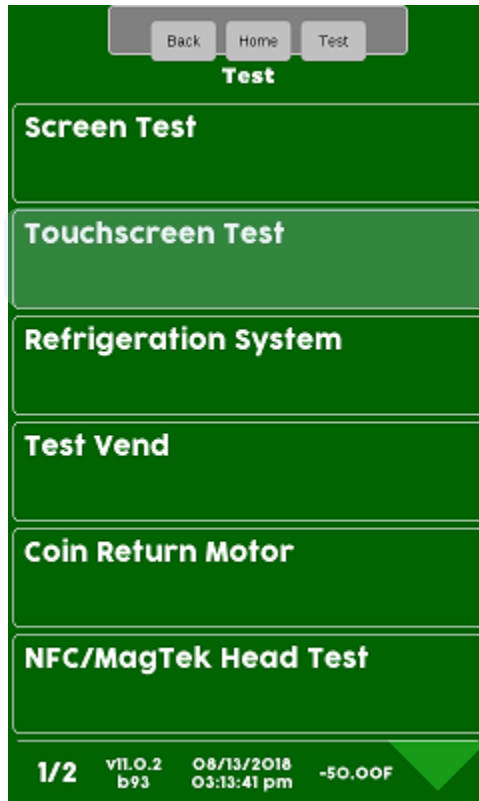

Touch anywhere on the screen and it will beep and the number of touches will be updated with every touch sensed.

Press the Exit icon to Exit.

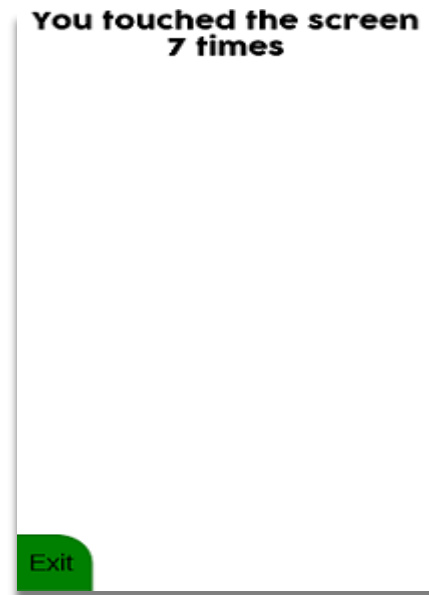

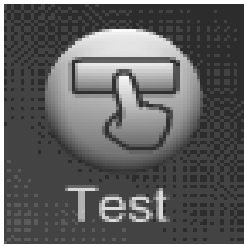

Test Menu

Refrigeration System

Touch Refrigeration System Test

Note: the refrigeration test menu will not appear if the machine is set to ambient.

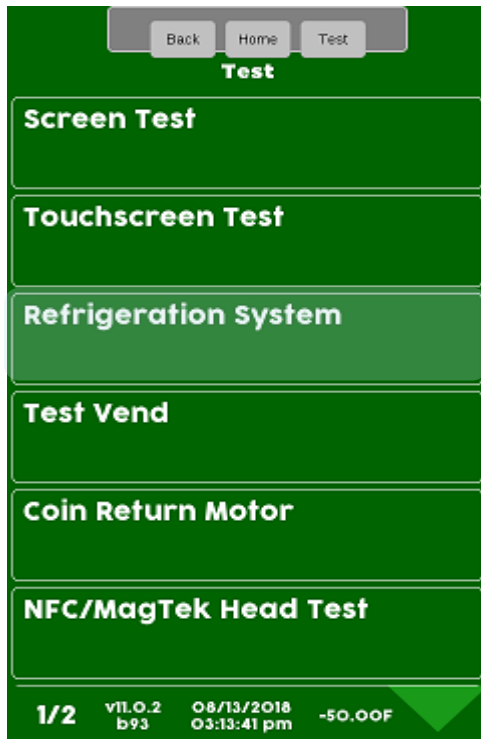

The display will show the current temperature for all the sensors in the machine as well as the current refrigeration Status ON/Off/Idle/Defrost and Time left on health if applicable.

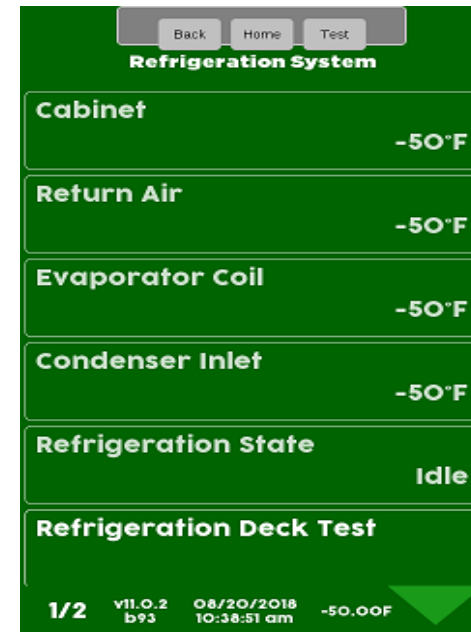

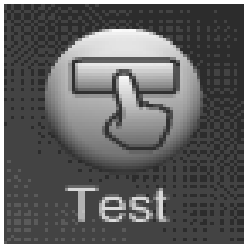

Test Menu

Refrigeration System

Touch Refrigeration Deck Test to Start the Test.

Note: The Refrigeration Deck Test will only function with the Monetary door open, and the glass door opened

Touch the appropriate menu bar to toggle the Compressor or Evaporator Fan On/Off

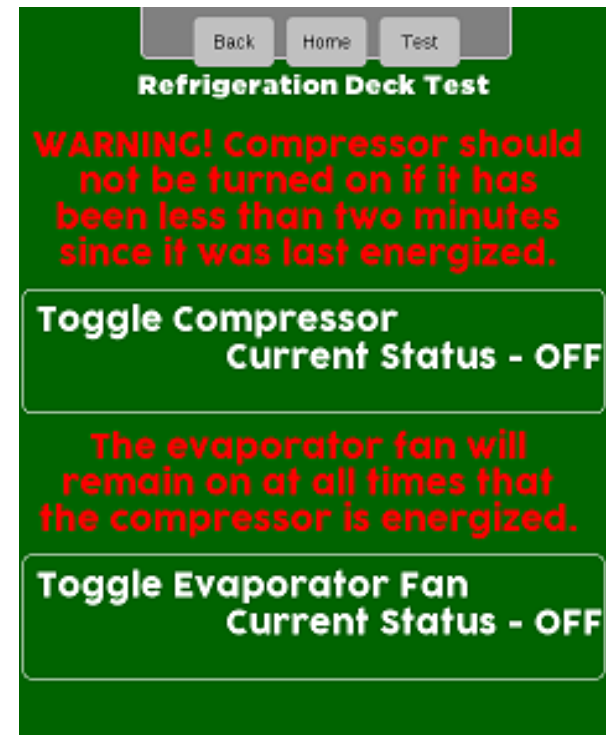
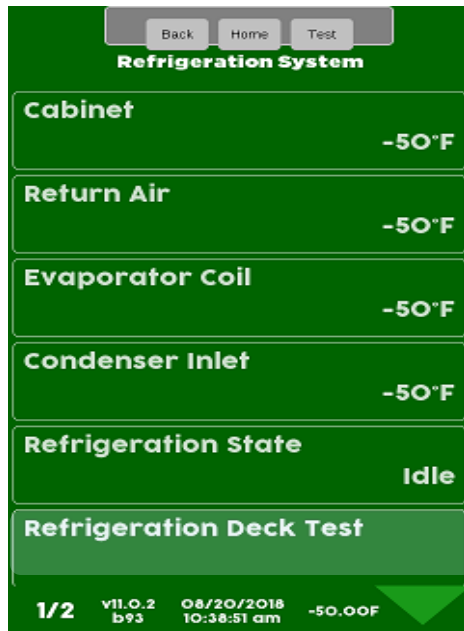

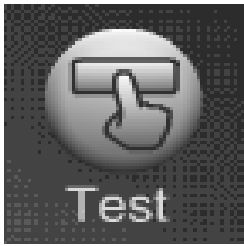

Test Menu

Test Vend

Touching Test Vend will bring up an additional menu.

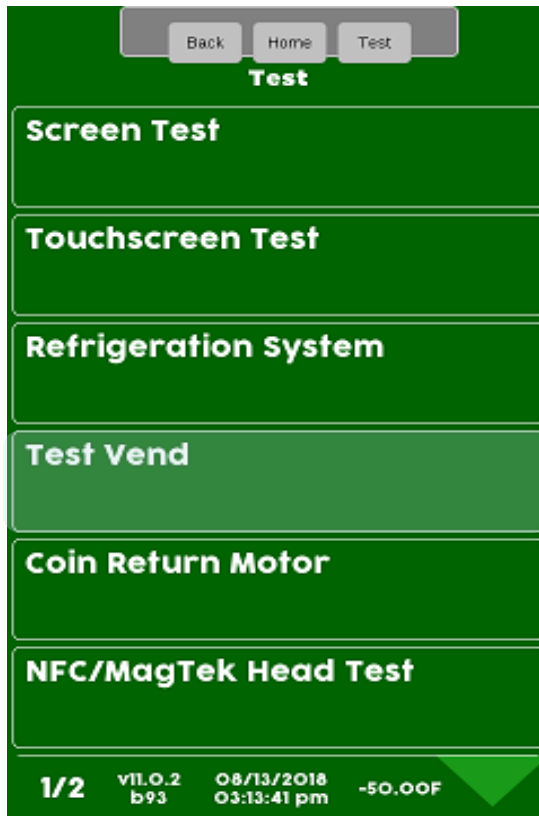

Choose Test Single Product or Test all Products

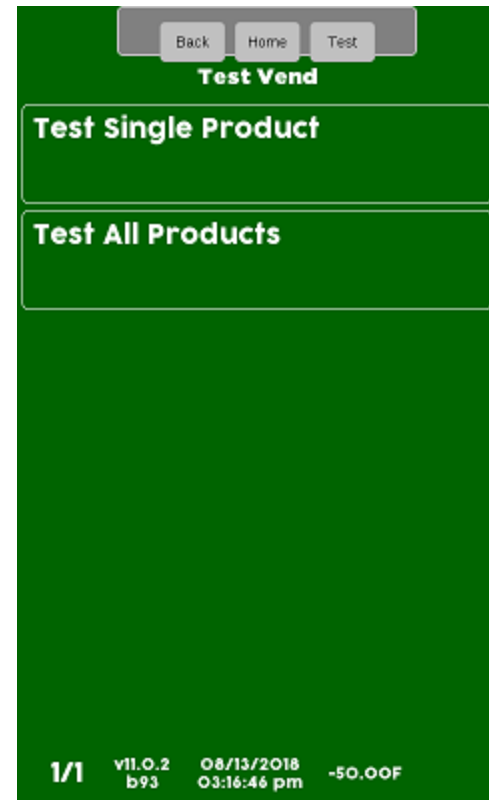

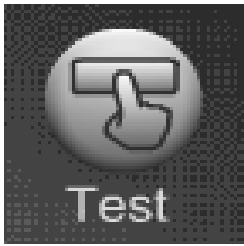

Test Menu

Test Vend – Test Single Product

Choosing Test Single Product will bring up the Test Vend options Menu.

Touch SureVend™ to toggle between off/on for the test. Do not turn on Free Vend to test a selection ?

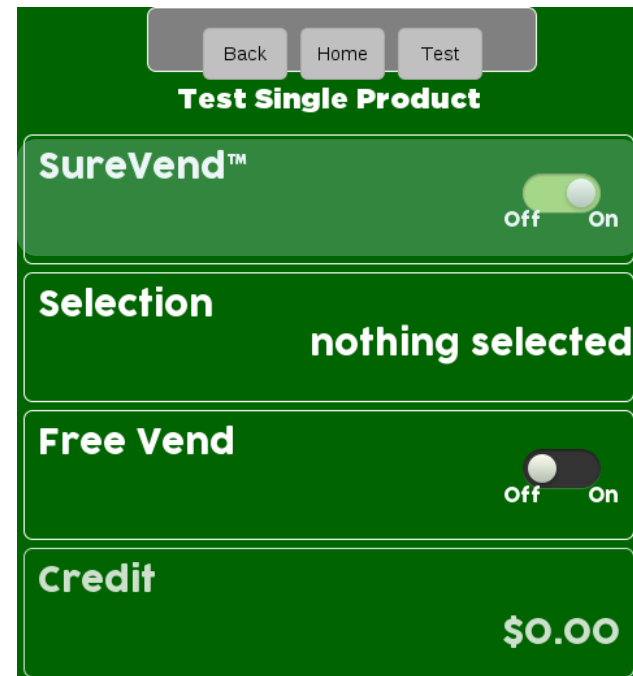

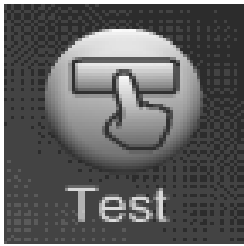

Test Menu

Test Vend – Single Products

Touch Selection

Touch a Tray

Touch a Selection

Page down and touch Start Vend to test the selection entered.

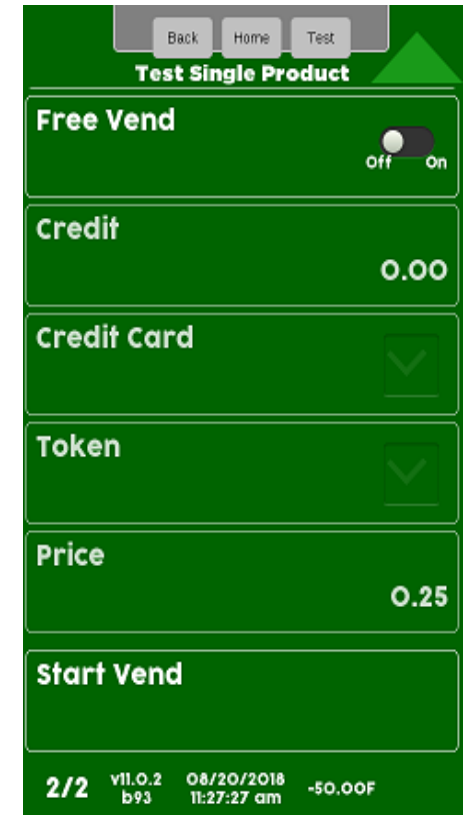
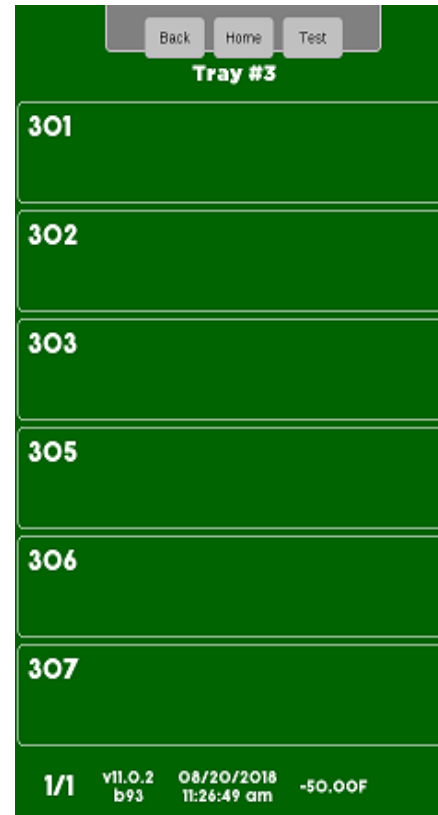

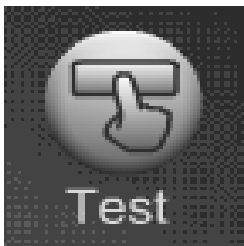

Test Menu

Test Vend – Test All Products

Choosing all Products will bring up the Test Vend options Menu.

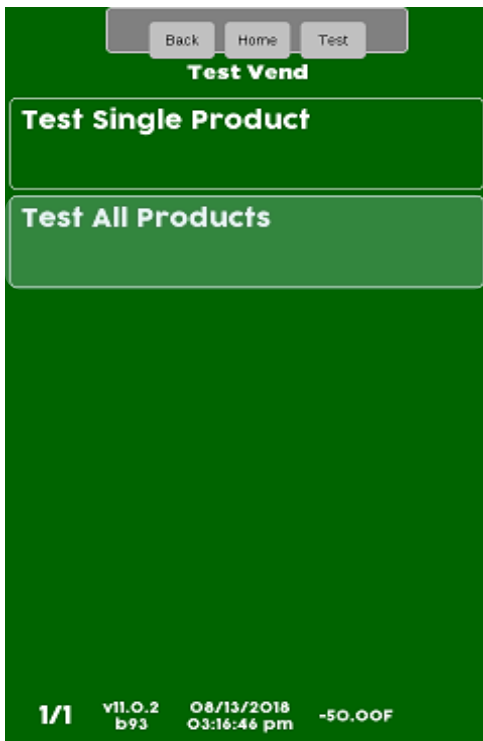

Touch Preform Test and the test will start

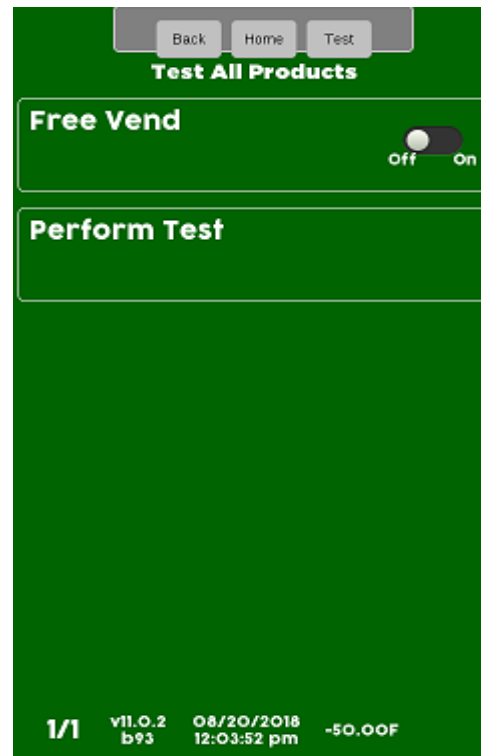

You can Pause Test or Stop the test. If you Pause, a Resume menu bar will appear as shown below.

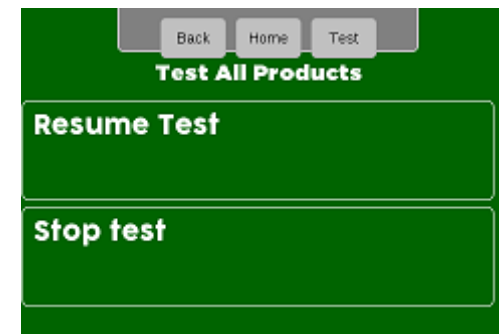
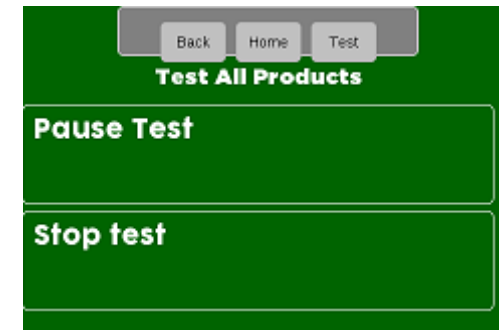

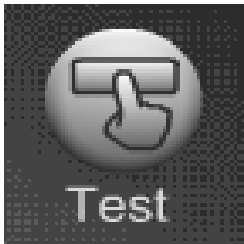

Test Menu

Coin Return Motor

Touch coin return Motor

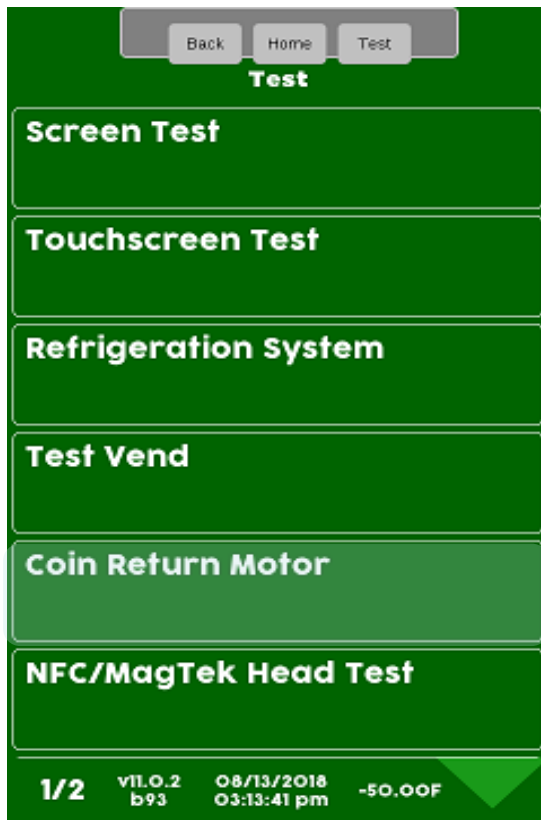

Press Perform Test and the coin return motor will start to run

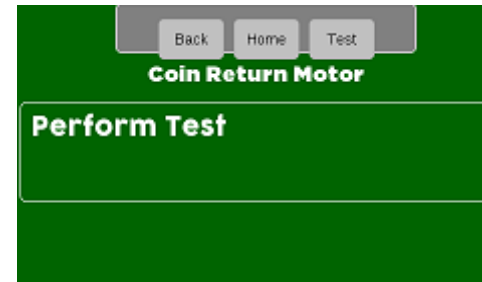

The display will show Test Complete or Test Failed

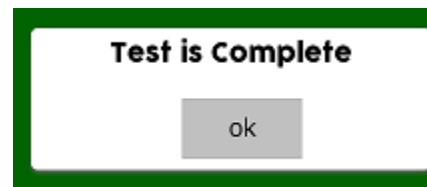

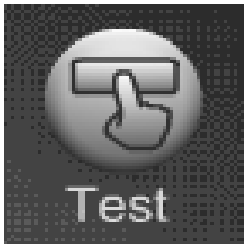

Test Menu

MagTek Head Test

Touch NFC/MagTek Head Test

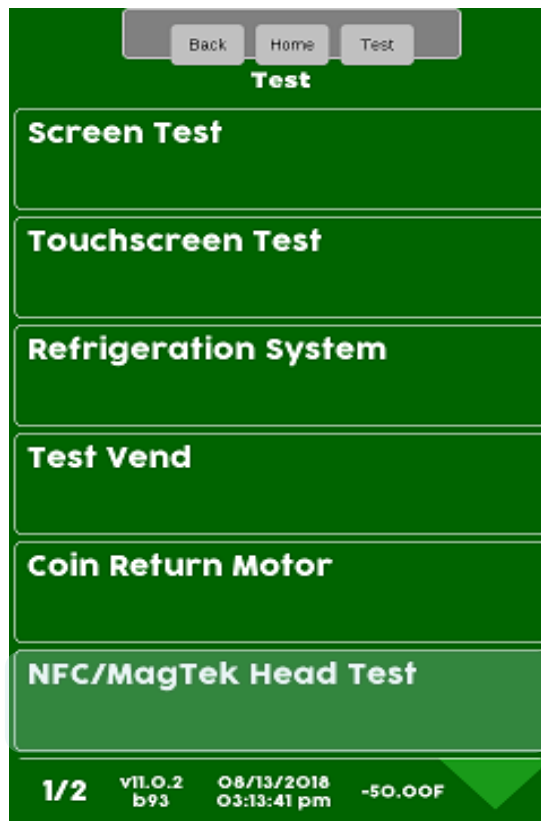

Swipe or Tap a card/device to test. The display will keep track of how many good swipes or taps versus bad, 28 good swipes or taps out of 30 is considered passing. A credit card does not normally have information on track 3.

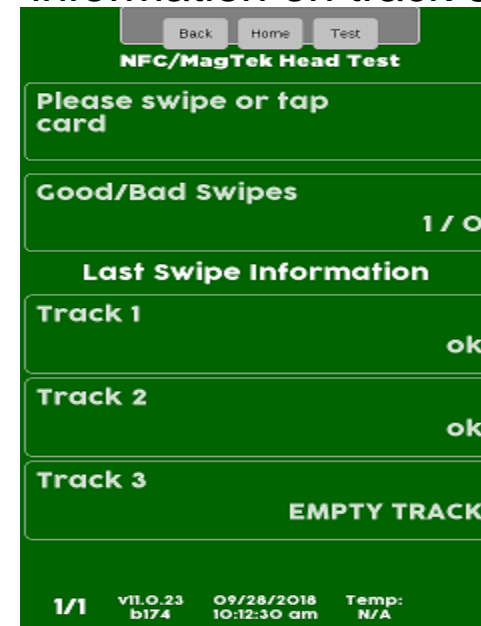

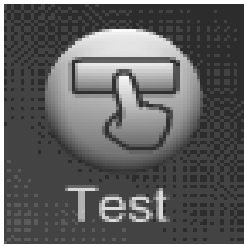

Test Menu

Motor Test Summary

Touch Motor Test Summary (in some cases you may have to touch the down arrow to scroll down to the menu bar).

The display will show the status of the Motors. On Page 2 you have the option to Home All motors or Home the Motors on an individual tray by touching one of the Icons below.

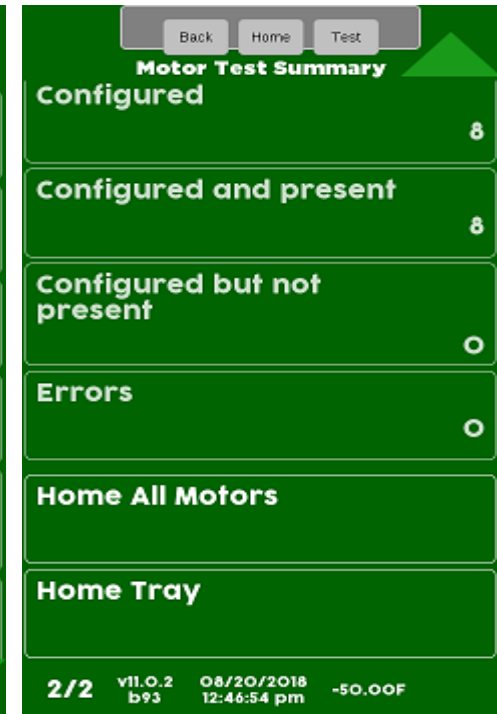
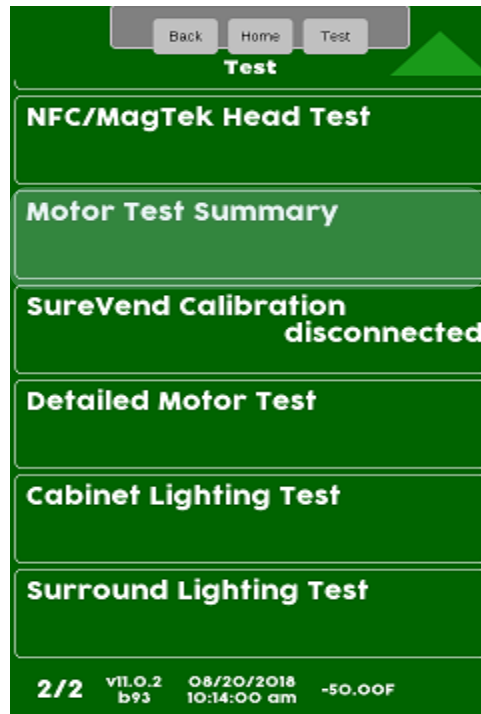

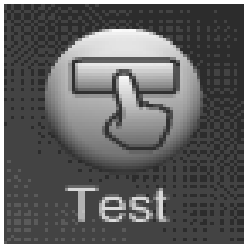

Test Menu

SureVend™ Calibration

Touch SureVend™ Calibration. If SureVend™ is disabled or disconnected it will show the status on the screen below.

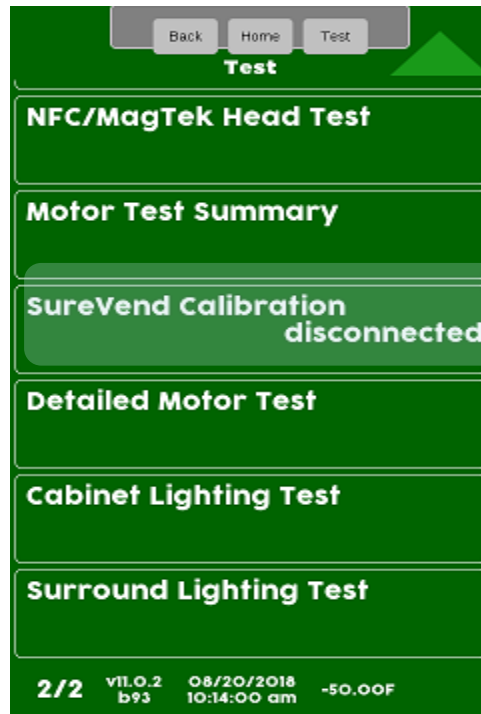

Number 1 is the sensor closest to the trays. Number 9 is closest to the glass. Fours, fives and sixes are all good. When you get into the teens that indicates a partial blockage. Zero indicates a complete blockage or bad sensor and the State line will show Blocked.

Back Home Test

SureVend Calibration

Emitter	Value	State
1	4	---
2	4	---
3	4	---
4	4	---
5	4	---
6	4	---
7	4	---
8	4	---
9	4	---

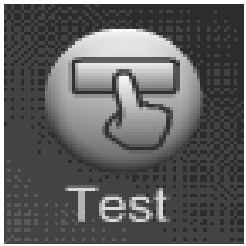

Test Menu

Detailed Motor Test

Touch Detailed Motor Test (in some cases you may have to touch the down arrow to scroll down to the menu bar).

Touch the tray you wish to view

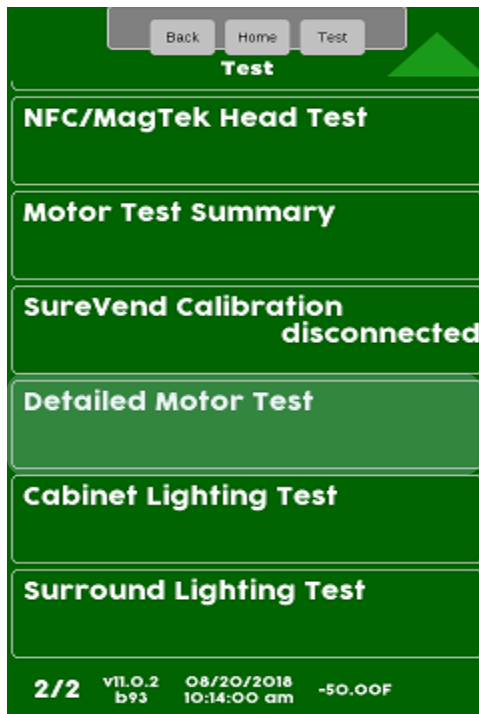

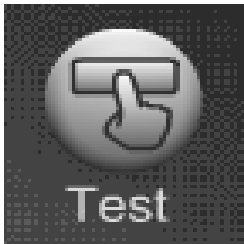

Test Menu

Detailed Motor Test

Note the status of the motor in this case homed is on the right side of the menu bar.

Choosing a selection will bring up a detailed report on the status of that motor and its associated events.

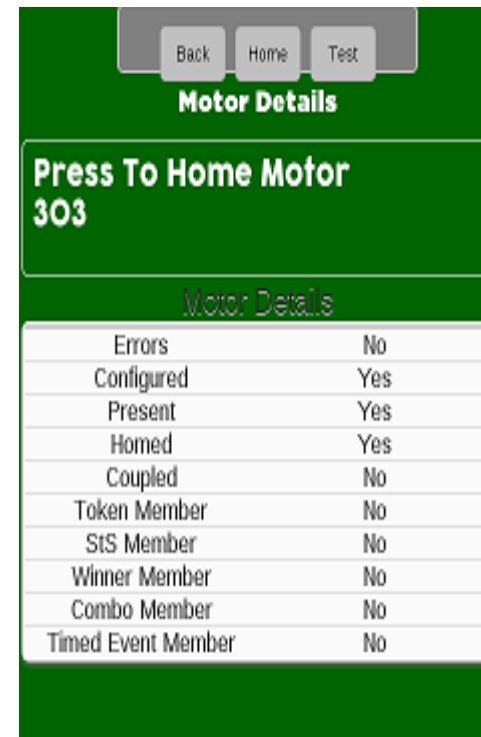
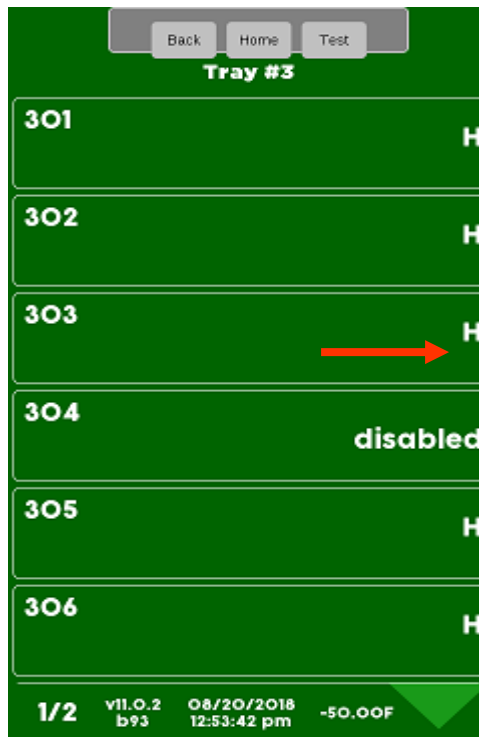

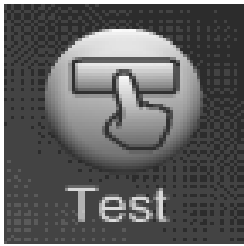

Test Menu

Cabinet Lighting Test

Touch Cabinet Lighting Test

Touch Toggle Cabinet Lighting to toggle the light relay between Off and On. Press Back to exit

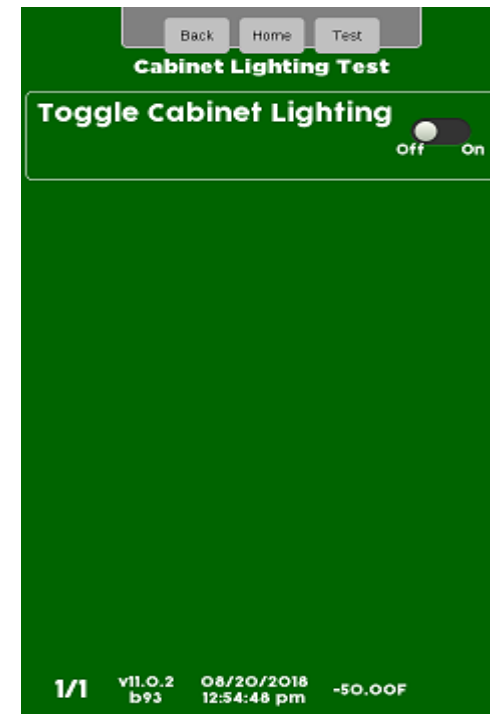
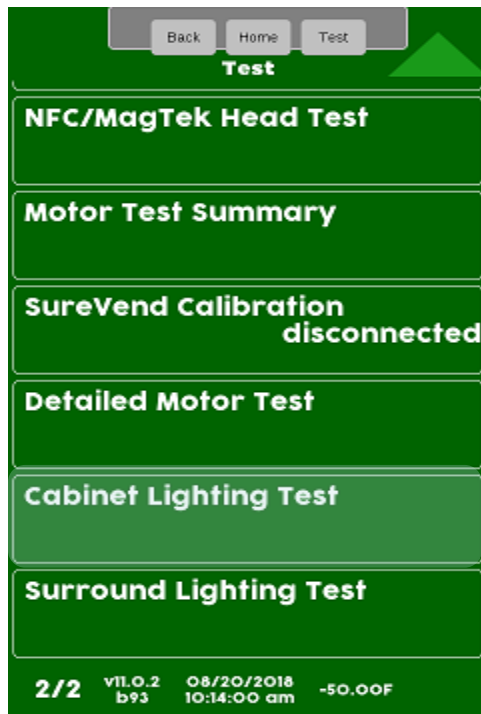

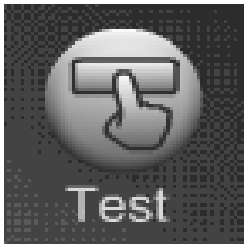

Test Menu

Surround Lighting Test

Touch Surround Lighting Test

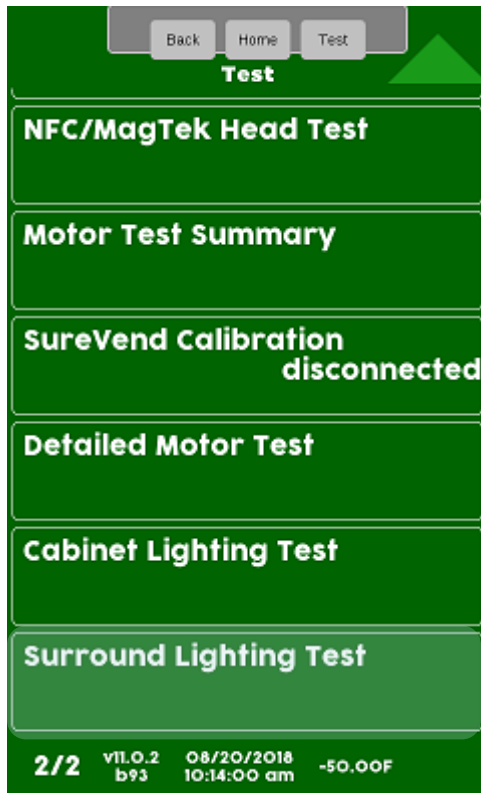

Touch Perform test to confirm the Lighting Test

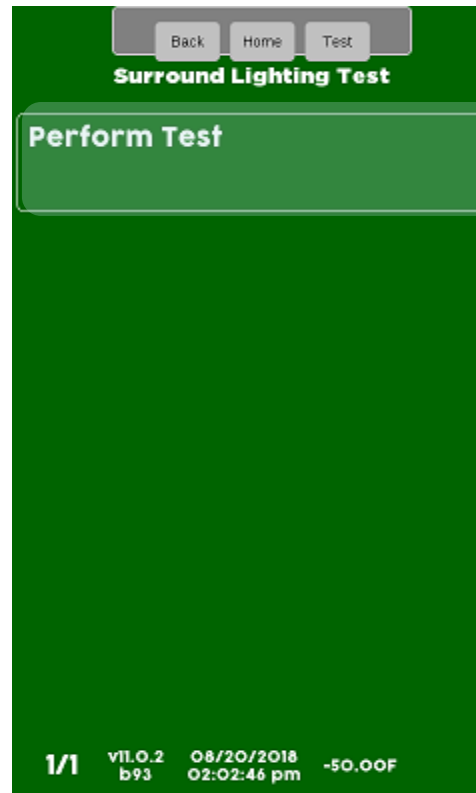

The Surround lights should be changing colors. Press Stop Test to terminate

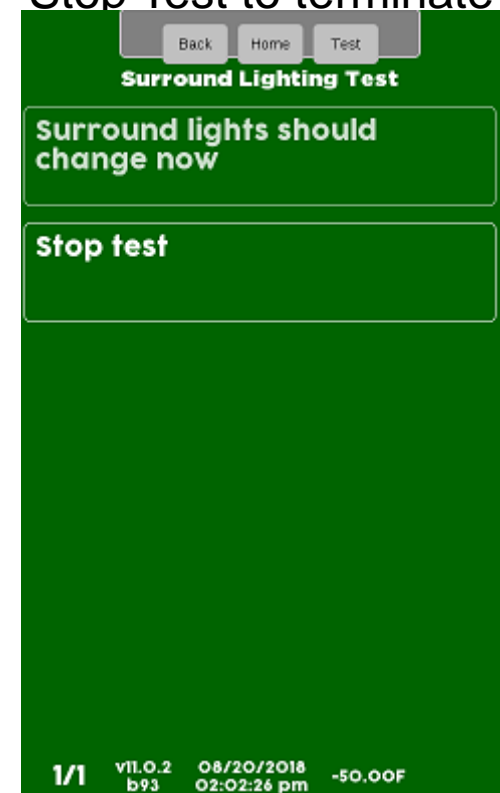



Product Configuration

- The Product Configuration menu provides access to the following modes in the machine:
 - Update Planogram
 - Selection Configuration
 - Remove Product Library
 - UPC/EAN (Package UPC)
 - Shopping Cart Setup
 - Space to Sales (FIFO)
 - View Planogram
 - Browse Categories
 - SureVend™
 - Couple Motors

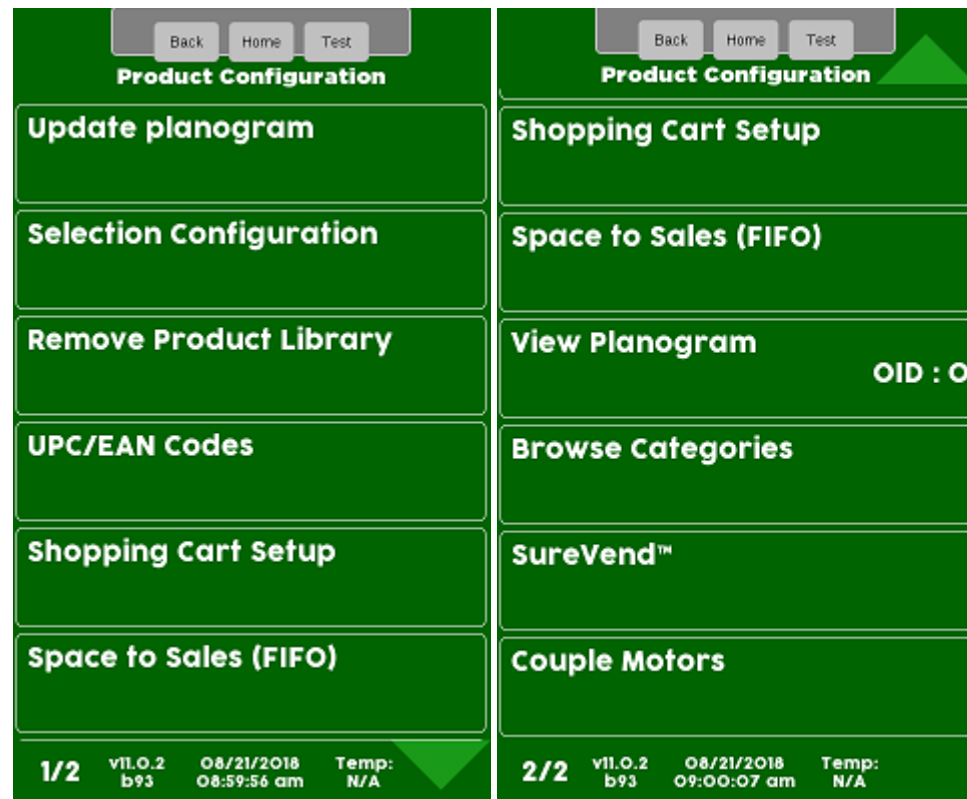



Product Configuration

Update Planogram - USB

Touch Update Planogram

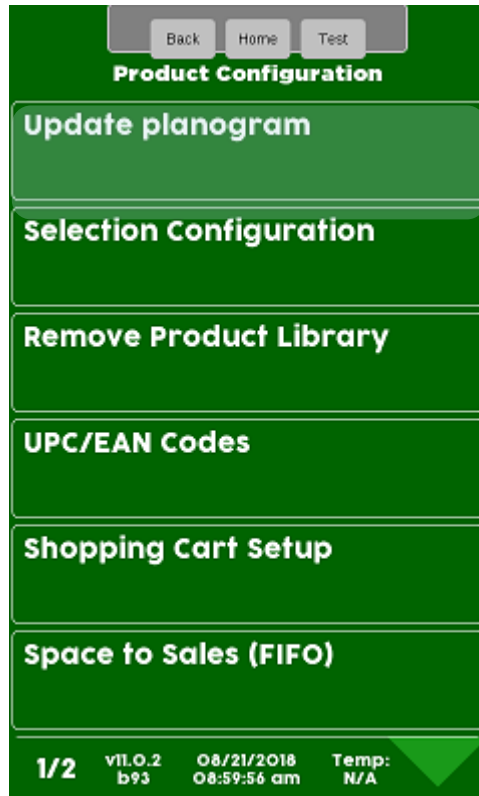

Choose Update from USB or if online with Crane you can Update from Server. If you choose update from USB the board will look for a flash drive already inserted into one of the USB ports that contains an atlas folder with planograms in the folder. If found it will list the available planograms found on the flash drive allowing you to choose which file you wish to load. If you choose Update from server the atlas board will attempt to call the server and download the planogram associated with the atlas board number.

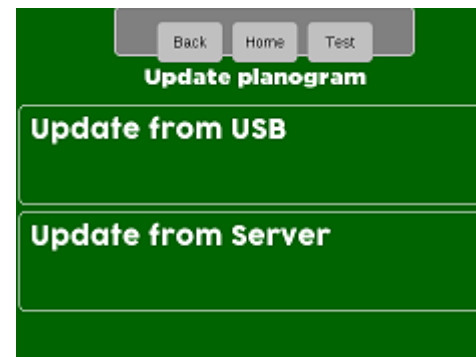



Product Configuration

Update Planogram

Loading a Planogram into the machine using a memory stick

- Before attempting to load a file you must create a folder on your USB flash drive named atlas. Copy your Planogram into the atlas Folder.
- Plug a flash drive in to an unoccupied USB port on the control board.
- You can have multiple Planograms in the atlas folder.

Note: Crane Merchandising Systems is providing the nutritional content information, based on information provided by the product manufacturers, and Crane MS is cannot accept responsibility for content created by others.

(Planogram Updates)

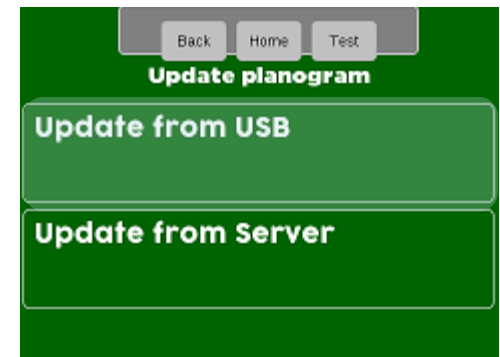



Product Configuration

Update Planogram

Touch Update from USB
(Planogram Updates)

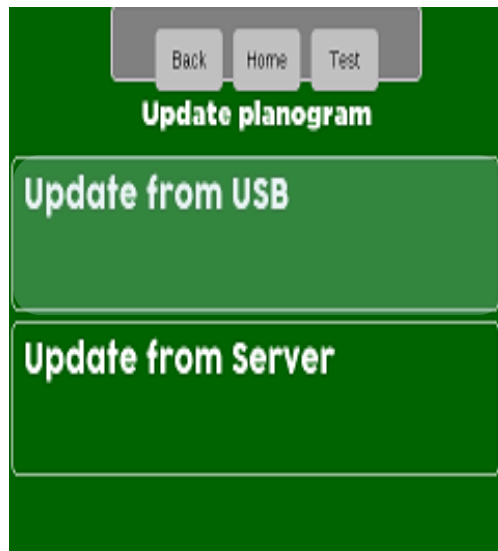

Touch the file you wish to upload to the machine and Touch start update.

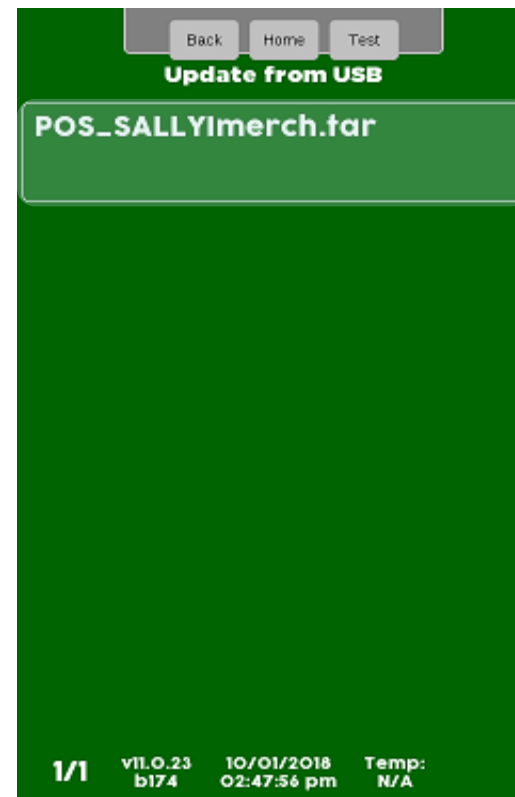



Product Configuration

Update Planogram

A conformation box will appear if you choose to update the POG. Touch YES to continue or No to Cancel.

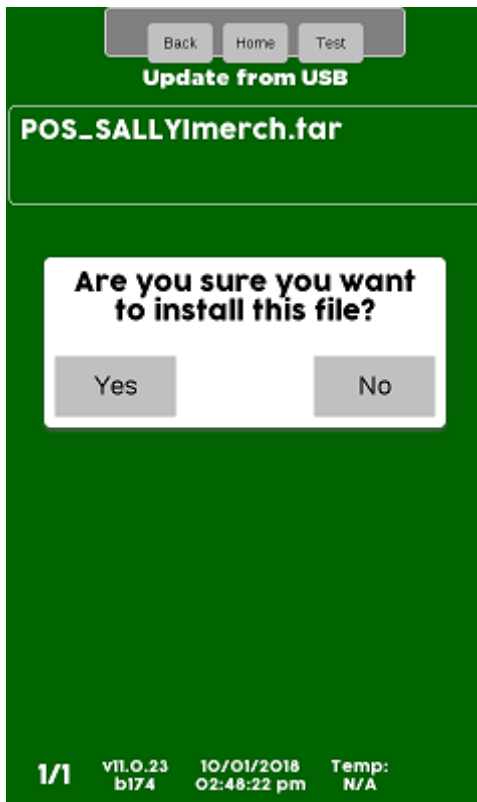

The display will confirm if the installation was successful. It is a good idea to create a backup once the POG file is loaded. The machine must be rebooted for the POG to take effect. A menu bar allowing you to reboot the machine and install the planogram will appear.

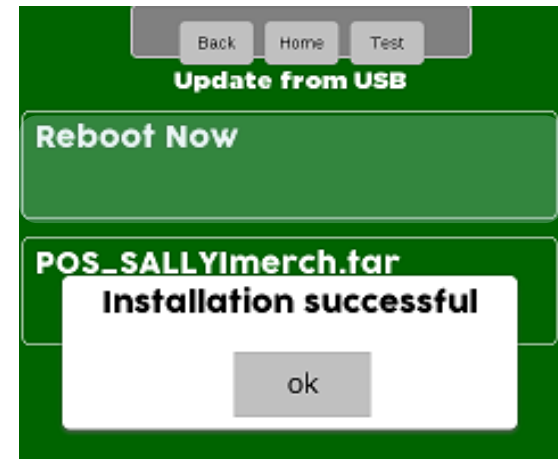



Product Configuration

Selection Configuration - Autoconfiguration

Touch Selection Configuration to enter the menu.

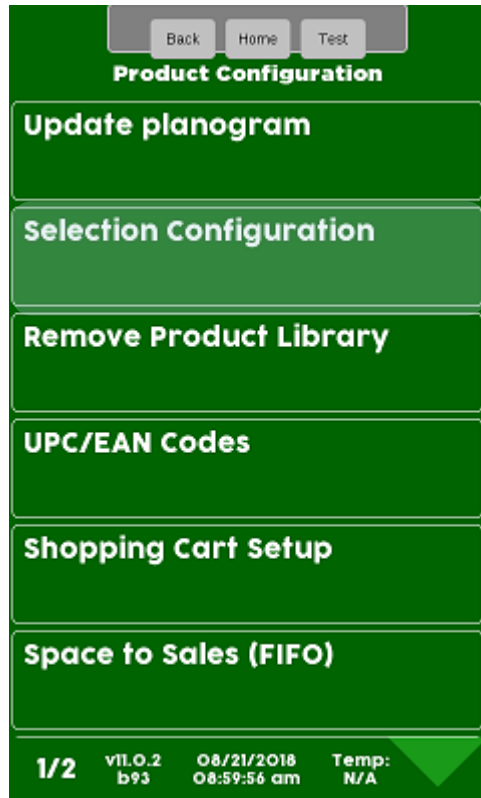

To automatically configure the motors Touch Perform Autoconfiguration .

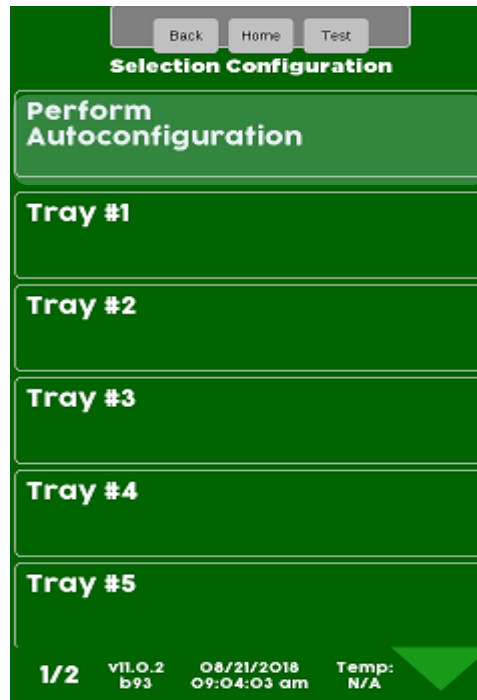

The controller will scan all the motors and automatically enable all motors that are detected.

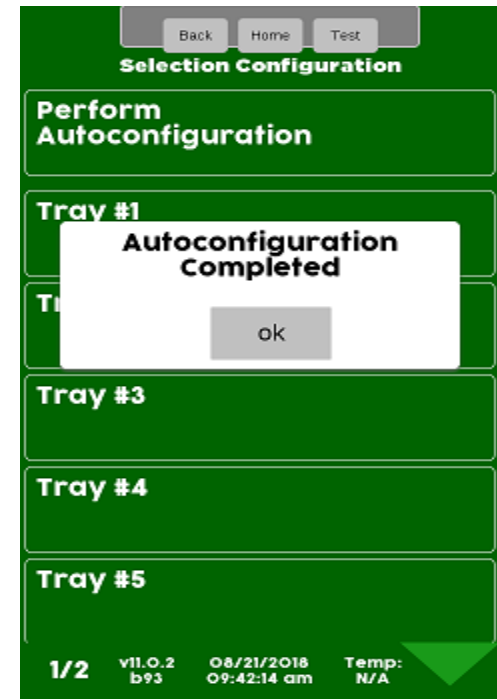



Product Configuration

Selection Configuration - Autoconfiguration

Choose a Tray to view results .

All Selections with a checkmark were found and added to the configuration

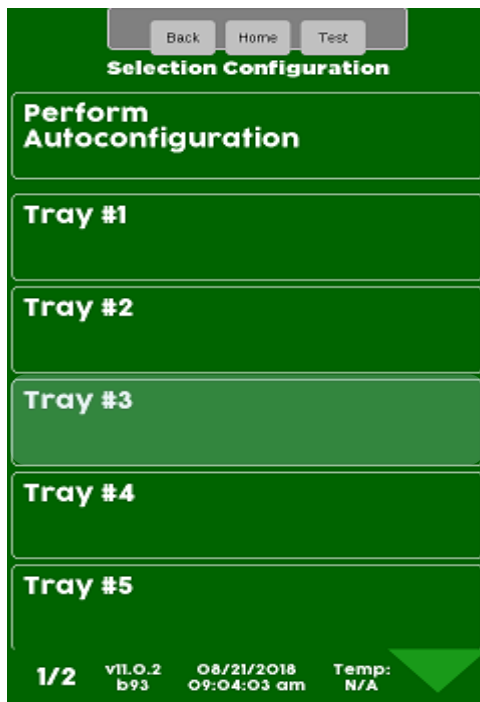



Product Configuration

Selection Configuration – Set Up Selections

To manually configure selections. Select the desired tray

Touch a selection to add or remove a checkmark. Motors with a checkmark are part of the configuration. In some cases the down arrow will be lit, indicating you can scroll down for additional selections.

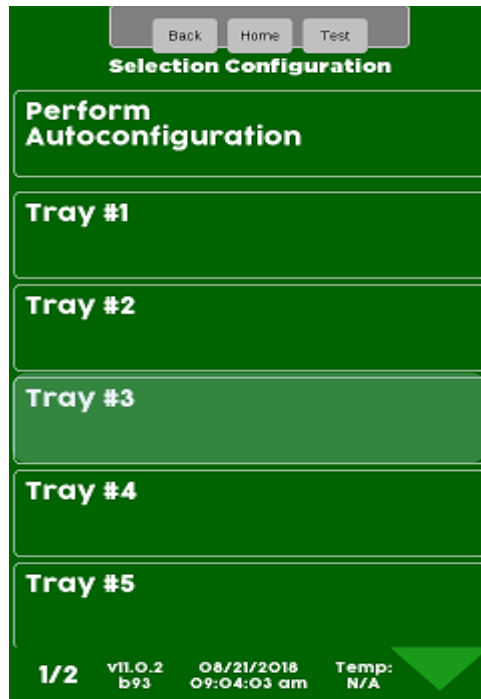



Product Configuration

Remove Product Library

Touch Remove Product Library to remove an existing library.

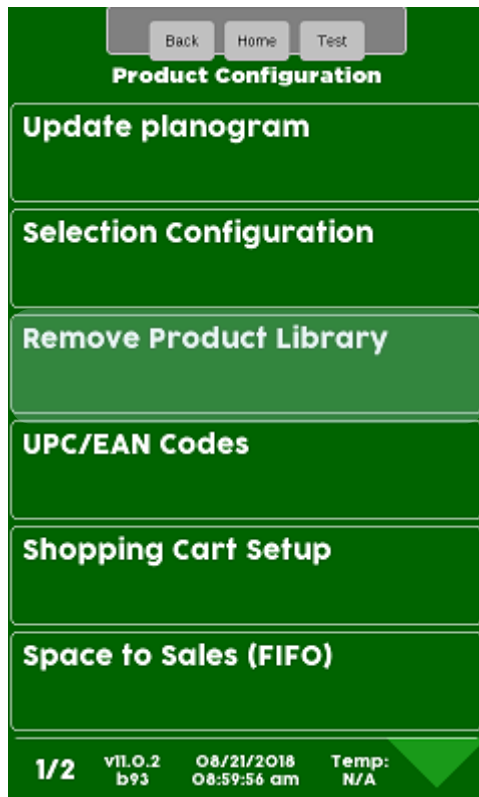

A confirmation box will appear, Touch Yes to confirm or No to cancel

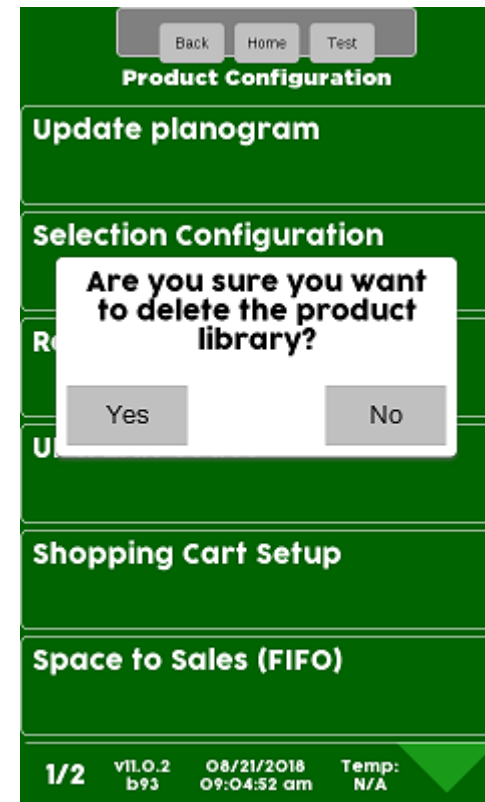



Product Configuration

Universal Product Code

To View or change the current UPC Touch Universal Product Code.

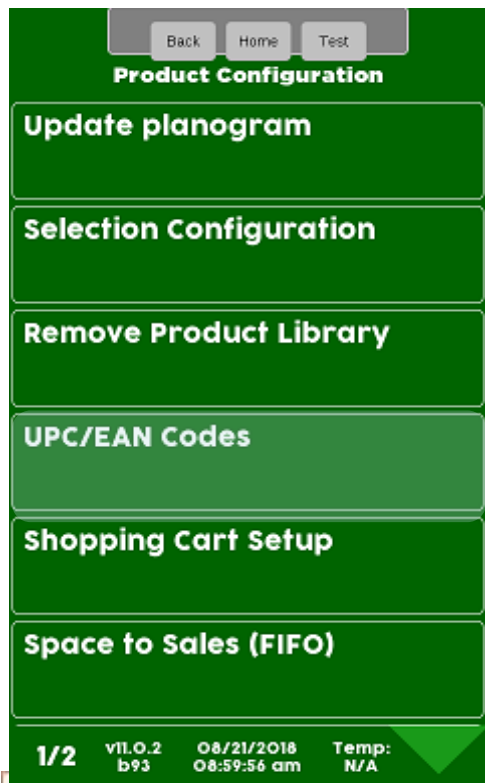

Select the tray that the product is on that you wish to view or change.



The display shows the current UPC/EAN assigned to the selections, choose the selection you wish to change.





Product Configuration

Universal Product Code

- For a UPC code to be valid, The UPC Code must be in the Library or Planogram loaded in the machine.
- Deleting a UPC Code will cause that selection to show a generic picture on the display and no nutritional information will be available for that selection.
- You can use the same UPC Code for multiple selections if you want two or more selections of the same product.
- Choose a selection and use the Numeric Keypad to enter the UPC code you wish to add.
- Press Accept to save and Cancel to exit without changes.
- Use the Aa key to switch to Alpha & #@ for symbols.





Product Configuration

Shopping Cart Setup

- This menu provides access to set up the Shopping Cart.
- Shopping Cart permits the user to select multiple items, and place them into a virtual “Shopping Cart” and purchase them in a single financial transaction.
- Recommended Shopping Cart maximum size is 3 items.
- Max Fund amount can should be calculated by multiplying the highest vend price in the machine times the Shopping Cart size.

Note: When Rapid Vend is turned on under the Special Vend Mode the Shopping Cart function is automatically disabled.

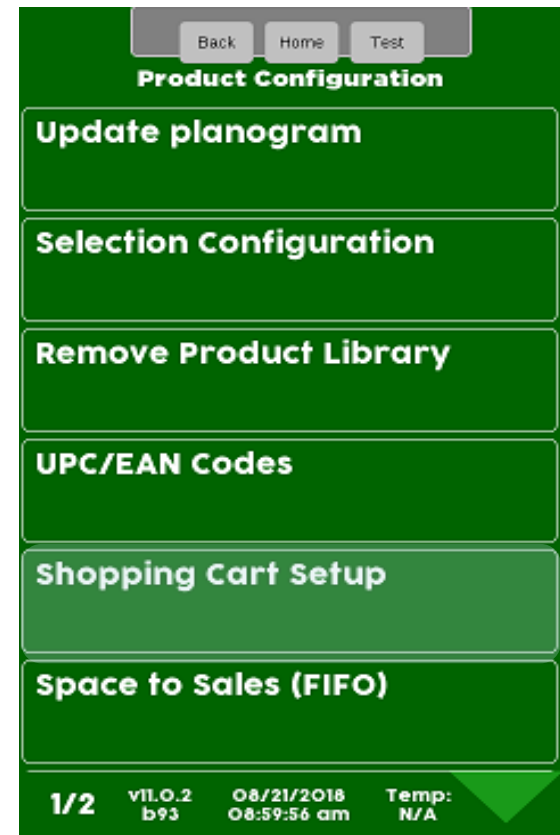



Product Configuration

Shopping Cart Setup

Touch Shopping Cart Size. Use the numeric keypad to enter the quantity (max 3) of items allowed in the Shopping Cart. Press Accept when finished

Back Home Test

Shopping Cart Setup

Shopping Cart Size 3

Max Fund Amount 5.00

Shopping Cart Size (1-3): 3

1	2	3
4	5	6
7	8	9
C	0	⊗

Accept Cancel

Select Max Fund Amount to set the maximum amount of funds in the cart. We recommend the cart size 3 times the highest vend price. Press Accept when finished.

Back Home Test

Shopping Cart Setup

Shopping Cart Size 3

Max Fund Amount 5.00

Max Fund Amount (0.00-10000.00): 5.00

1	2	3
4	5	6
7	8	9
C	0	⊗

Accept Cancel

Continued →



Product Configuration

Shopping Cart Setup

Note: The Max Fund amount menu can also be utilized allow the machine to be used as a bill changer.

For example, if you wish to allow for change of a \$10.00 bill, you can set the Shopping Cart Max Fund Amount to \$10.05, which will allow the machine to stack a \$5 or \$10 bill. When the coin return is pressed, change is returned. The same idea applies to a \$5 or \$20 bill, using \$5.05 or \$20.05 respectively.

If Rapid Vend is turned on you must turn it off for the shopping cart menu to appear, set the amount to be paid back in this menu, then turn Rapid Vend back on if desired.

A screenshot of a touch-screen interface for "Shopping Cart Setup". At the top, there are three buttons: "Back", "Home", and "Test". Below them is the title "Shopping Cart Setup". The screen is divided into two main sections. The first section, titled "Shopping Cart Size", shows the value "3". The second section, titled "Max Fund Amount", shows the value "5.00". Below these sections is a numeric keypad with buttons for digits 1-9, 0, a "C" (clear) button, and a "cancel" button (represented by a crossed-out square). At the bottom of the screen, there are two large buttons: "Accept" (green) and "Cancel" (red).



Product Configuration

FIFO

Space to Sales (STS)

First In, First Out (FIFO)

- **FIFO** allows you to program your machine to run multiple selections as a single selection.
- No matter which selection ID of the group is entered, the machine will vend round-robin from the group of spirals, skipping selections that are out-of-service.
- This feature can provide a First-In-First-Out for perishable foods.
- It also helps to prevent one spiral of duplicate selections from going empty before the others of the same selection.
- **Note: Ensure that all selections chosen for each FIFO group are the same price. If not, the machine will price all selections to the highest price in the group.**

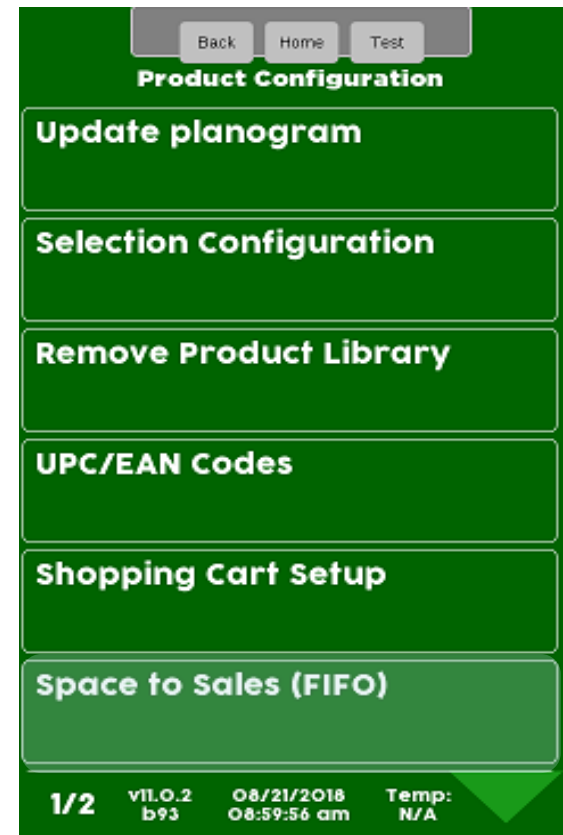



Product Configuration

Space to Sales (FIFO) Continued

The Space to Sales (STS) First in First Out (FIFO) menu allows you to:

- Set up Auto STS (FIFO)
- Add a Group
- Delete a Group
- Edit a Group
- View Existing Groups (Mappings)

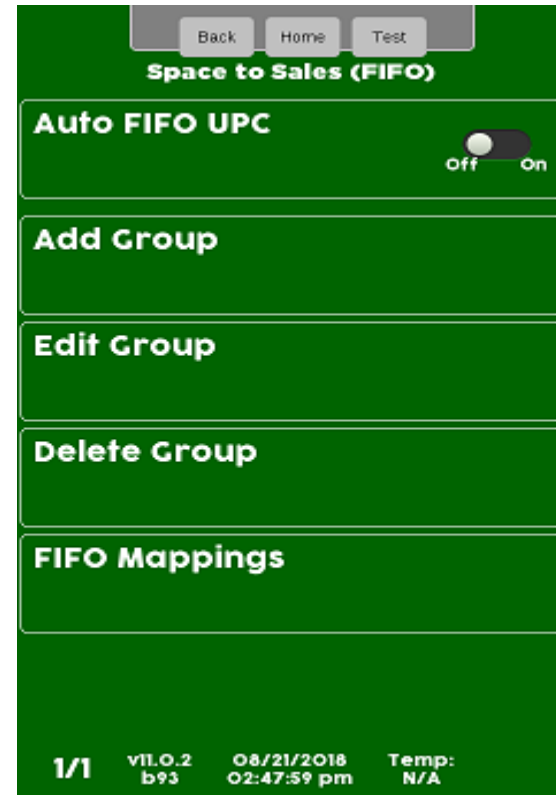



Product Configuration

FIFO – Add a Group

Touch Auto FIFO UPC
to toggle between off &
on

If you toggle Auto FIFO to On the machine will look at the UPC/EAN codes assigned to the selection at tie those selections together. As shown below if you select 301 you product will be delivered in order so if you select 301, the product could be delivered from 301,303, or 305.

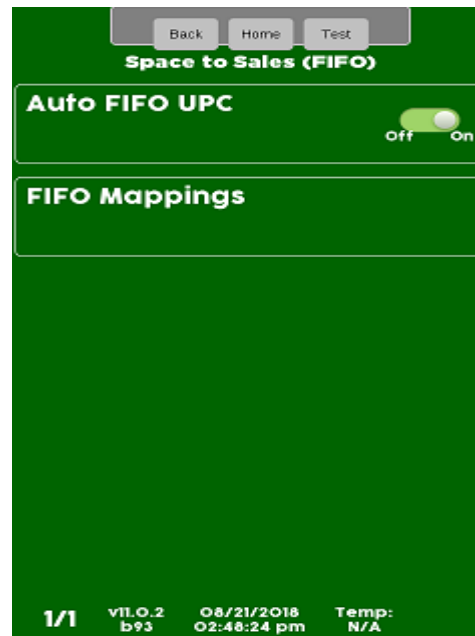
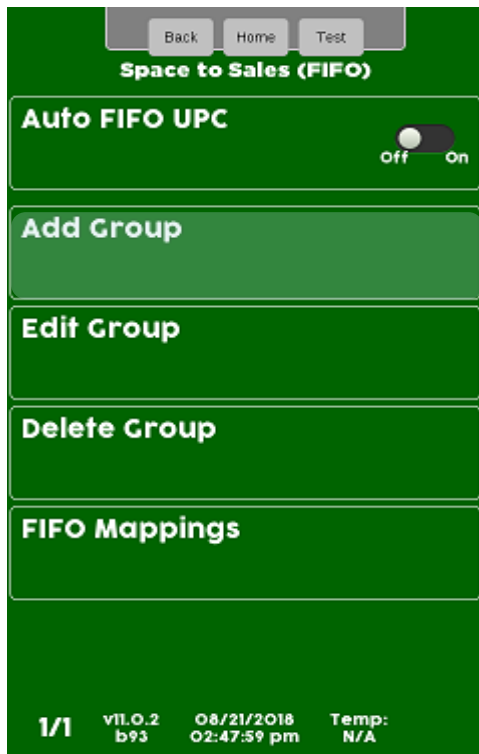



Product Configuration

Space to Sales FIFO – Add a Group

Touch Add a FIFO Group

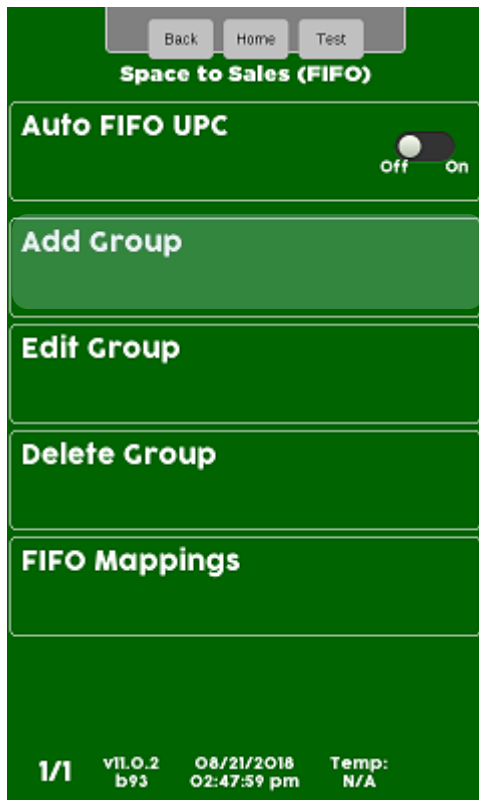

Touch the desired tray to add selections to the Group.



All available selections are shown. Touch the selection to add a checkmark to the motors to be part of the Group. In some cases the down arrow will be lit to scroll to additional selections.

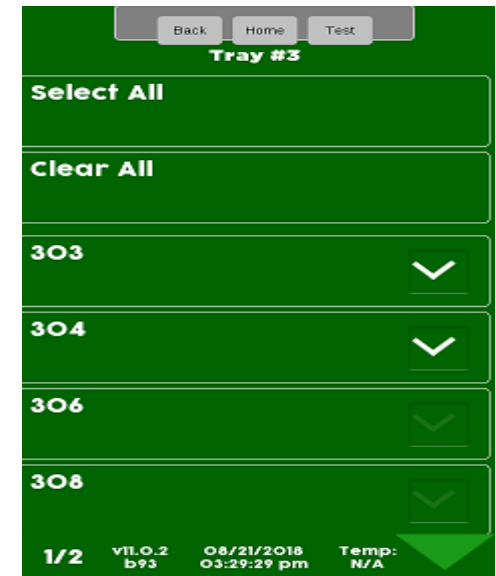



Product Configuration

Space to Sales FIFO – Add a Group

- All available selections are shown.
- Touch a selection to add a checkmark to the motors that will be part of the Group.
- In some cases the down arrow will be lit allowing you to scroll to additional selections.
- Press back to add more selections from another tray or to Create the Group.

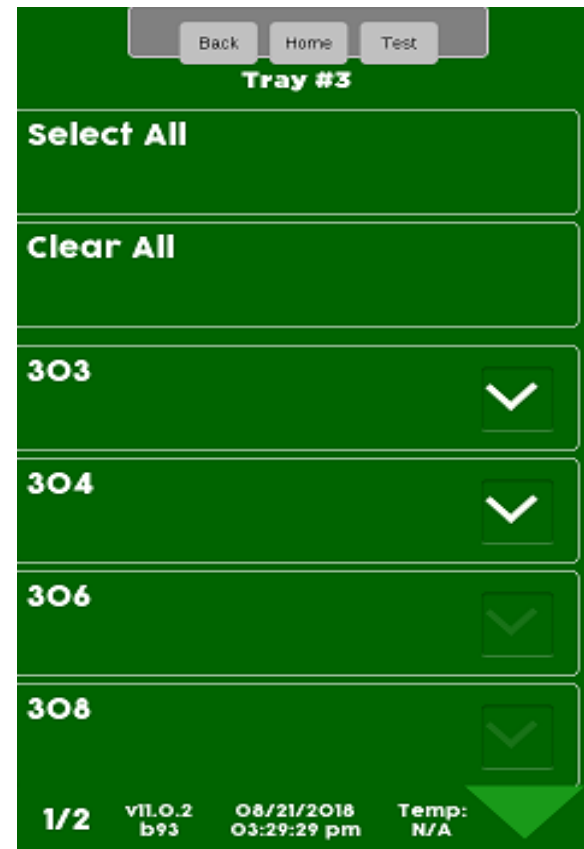



Product Configuration

Space to Sales FIFO – Edit a Group

Touch Edit a FIFO Group

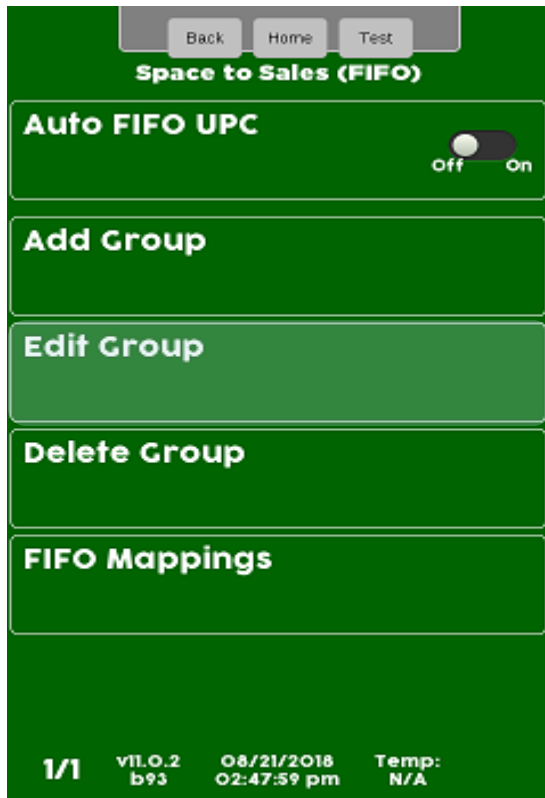

Touch the desired Group to Edit.





Product Configuration

Space to Sales FIFO – Edit a Group

Select the Tray you wish to Edit



Touch selections to check or uncheck them from the group. Use Select all to enable or Clear all to disable all selection on the tray. Press Back when finished to exit.

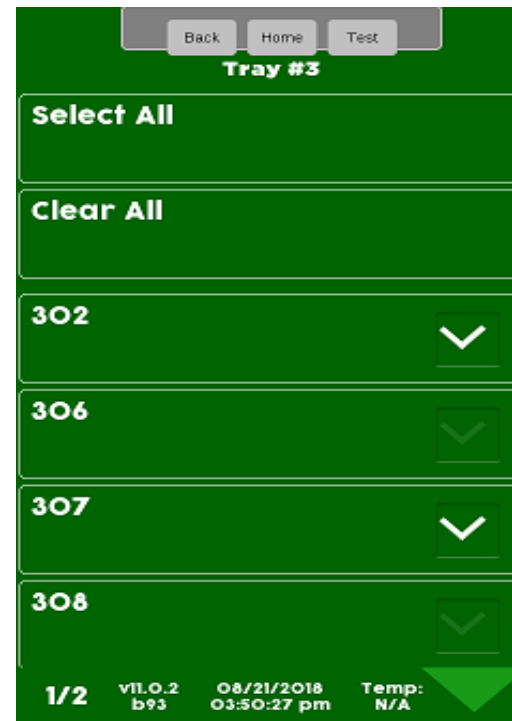



Product Configuration

Space to Sales FIFO – Delete a Group

Touch Delete Group to Delete a FIFO Group

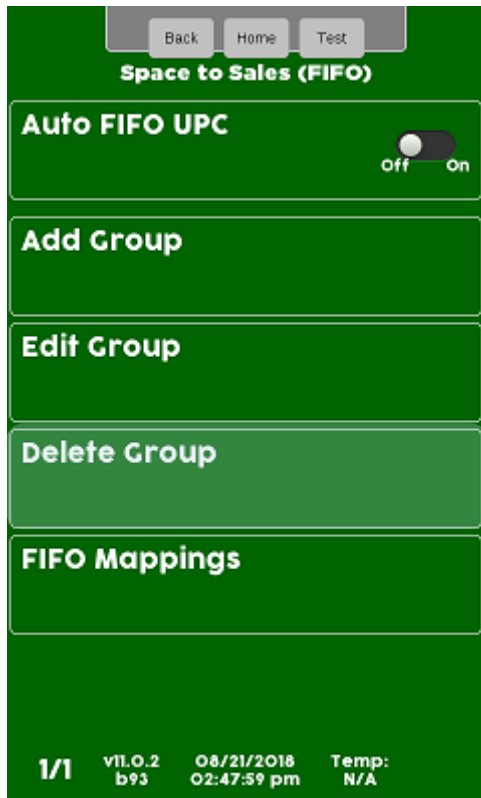

Touch the desired Group to be Deleted.



A confirmation box will appear, Touch Yes to confirm or No to cancel

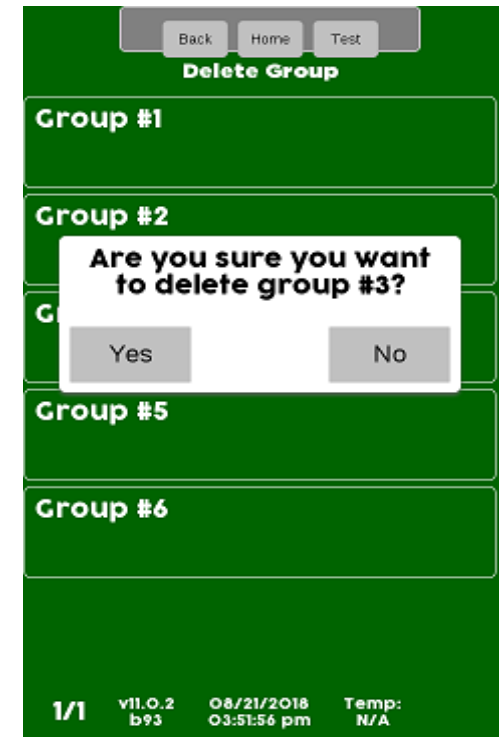



Product Configuration

Space to Sales FIFO – Mappings

Touch FIFO Mappings.

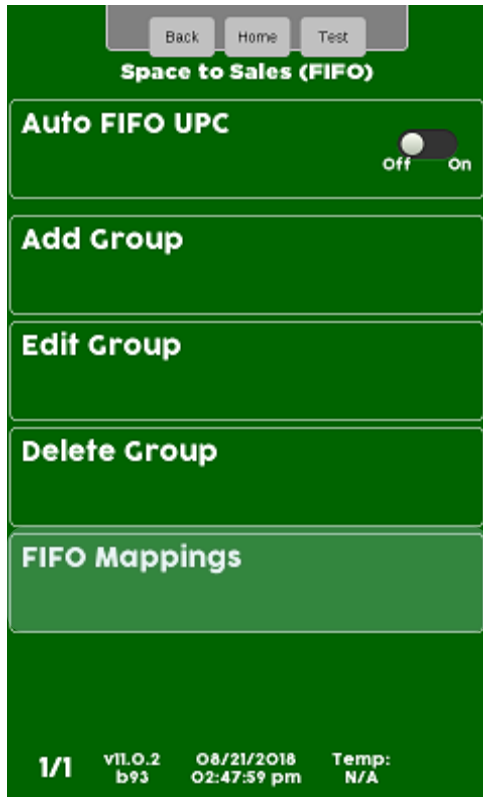

Touch a tray to view the current mappings.



The display will show the current Mapping for the motors on the tray selected.





Product Configuration

View Planogram

Touch Planogram to View an existing Planogram

If a Planogram has been loaded into the machine, a picture of the product for each selection will be shown. If not the selection number and price will be shown

Back Home Test

Product Configuration

Shopping Cart Setup

Space to Sales (FIFO)

View Planogram OID : 0

Browse Categories

SureVend™

Couple Motors

2/2 v11.0.2 08/21/2018 Temp:
b93 09:00:07 am N/A

Planogram Close

101 \$0.10	103 \$0.10	105 \$0.10	107 \$0.10	109 \$0.10	111 \$0.10						
201 \$0.30	203 \$0.30	205 \$0.30	207 \$0.30	209 \$19.95	211 \$0.30						
301 \$0.10	303 \$0.10	305 \$0.10	307 \$0.10	309 \$0.10	311 \$0.10						
401 \$0.20	402 \$2.25	403 \$0.20	404 \$2.25	405 \$0.20	406 \$2.25	407 \$0.20	408 \$2.25	409 \$0.20	410 \$2.25	411 \$0.20	412 \$2.25
501 \$0.10	502 \$0.10	503 \$0.10	504 \$0.10	505 \$0.10	506 \$0.10	507 \$19.95	508 \$0.10	509 \$0.10	510 \$0.10	511 \$0.10	512 \$0.10
601 \$0.20		603 \$19.95	605 \$0.20	607 \$0.20	609 \$0.20	611 \$0.20					



Product Configuration

Browse Categories

Touch Browse Category to access the menu to enable or disable categories

Touch a menu bar to add or remove a checkmark from the categories you wish to enable/disable

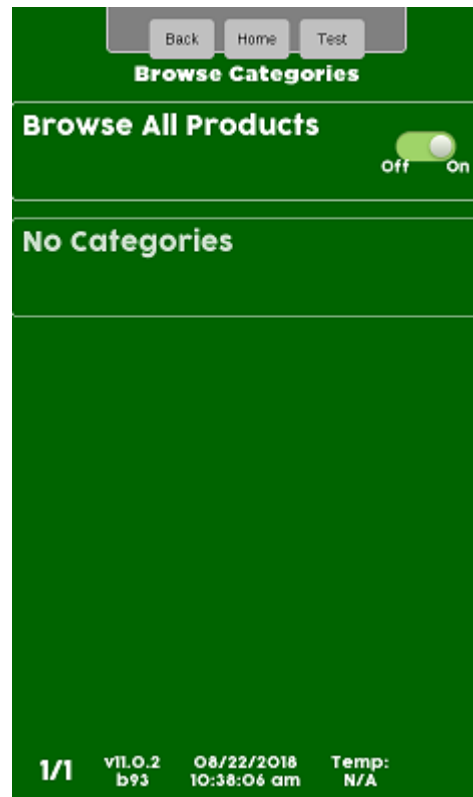
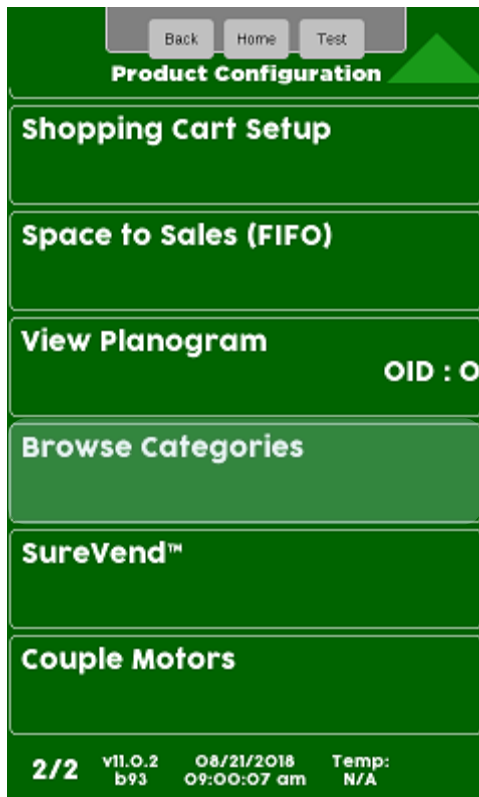



Product Configuration

SureVend™

SureVend™

- ***The SureVend™ Bin Sensor ensures a positive vend every time.***
- The sensor is installed in the delivery bin and senses that a product has been delivered.
- If no product was delivered, the spiral will make two additional turns.
- If the product is not delivered after three attempts, the machine will allow the customer to make another selection or press the coin return and receive their change back.

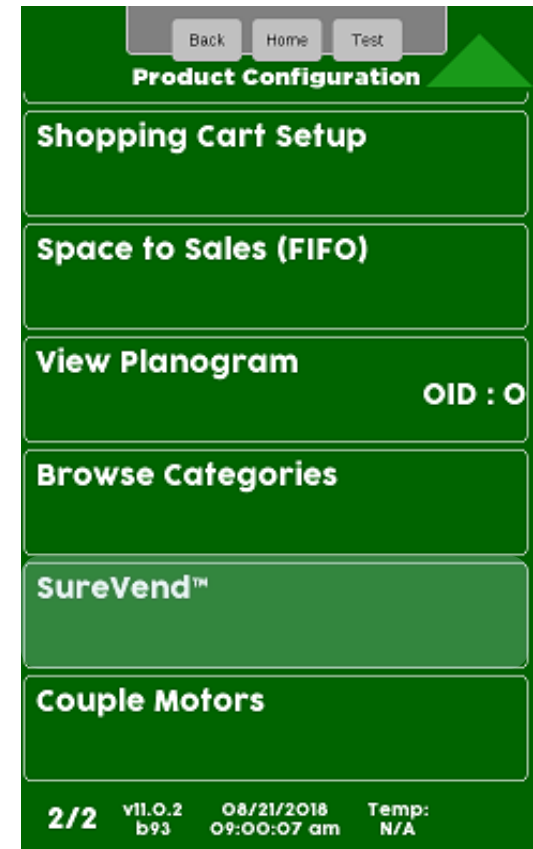



Product Configuration

SureVend™ - Current State

Touch SureVend™ to enter the SureVend™ Menu.

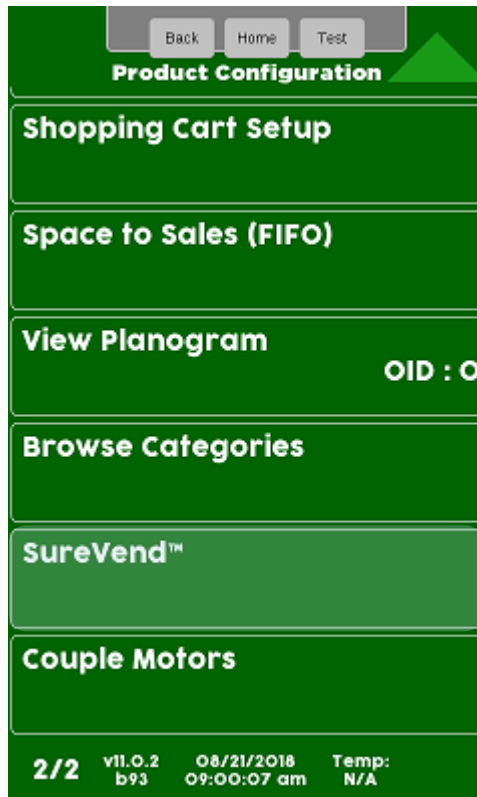

Touch SureVend™ to toggle between Off and On.

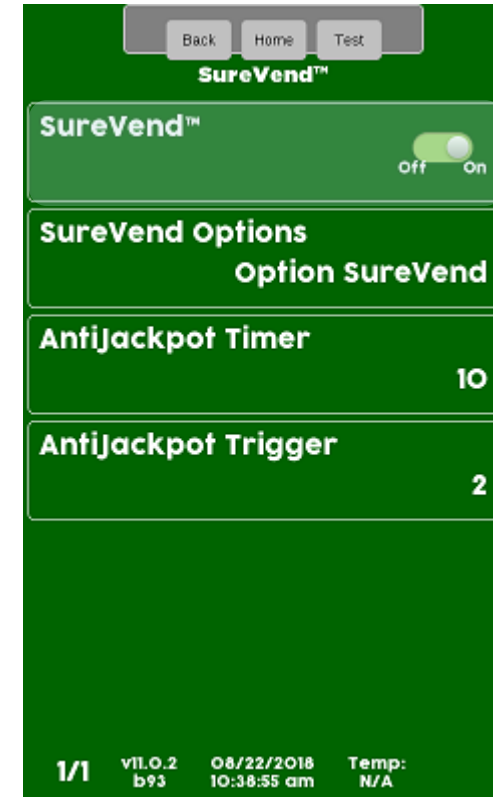



Product Configuration

SureVend™ Options

Touch SureVend™ Options to toggle between Must Surevend and Optional SureVend™. The current setting is shown on the menu bar.

Option SureVend™, if the SureVend™ stops working the machine will stay in order and the spiral will turn only once.

Must SureVend, if the SureVend™ stops working, the entire machine will go out of service.

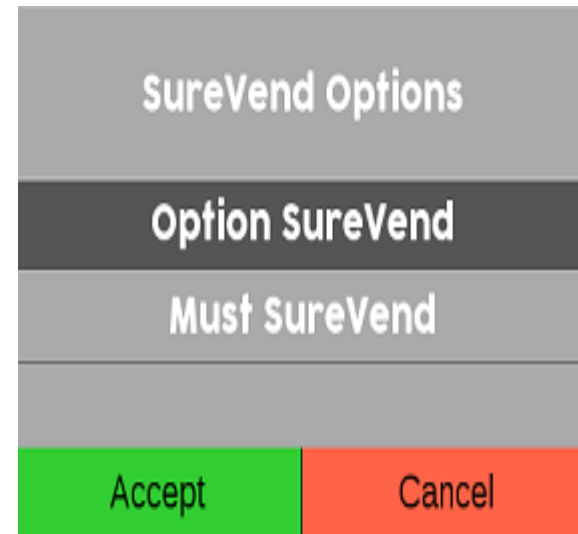



Product Configuration

SureVend™

Touch to change the Anti-Jackpot (AJT) timer, the default time is 10 minutes

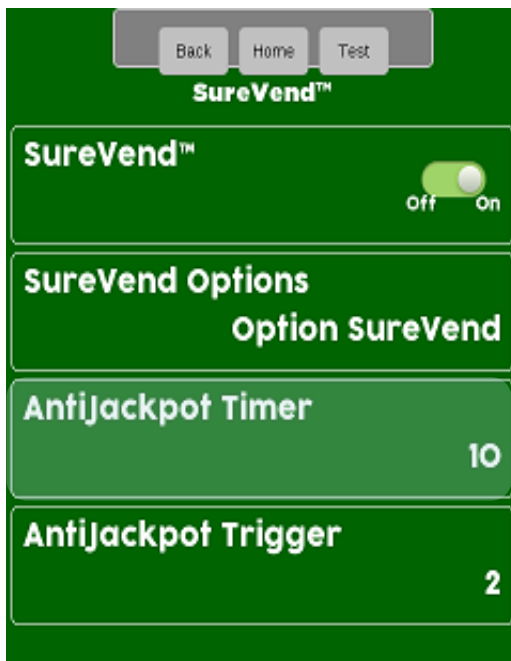

Use the Keypad to enter a new time (in minutes) and press Done. If a spiral turns 3 times and no product is detected by the SureVend™ sensor, that selection will be unavailable for the period of time set. After the AJT is expired, the selection will be available for purchase again, The SureVend™ will protect the customer from losing money during this time.





Product Configuration

SureVend™

Touch to change the Anti-Jackpot Trigger, the default is 2.

The Anti-Jackpot Trigger is how many consecutive selections the machine will allow to turn 3 times before assuming there is a SureVend™ issue and take the money. The default setting is 2. Use the keypad to enter the new setting and press Accept.

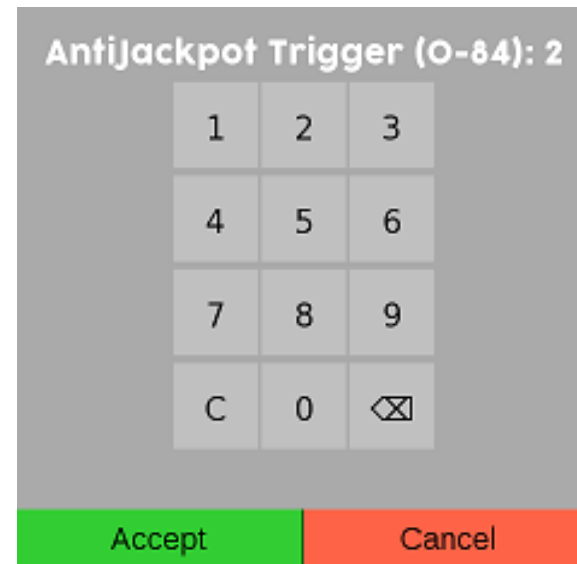
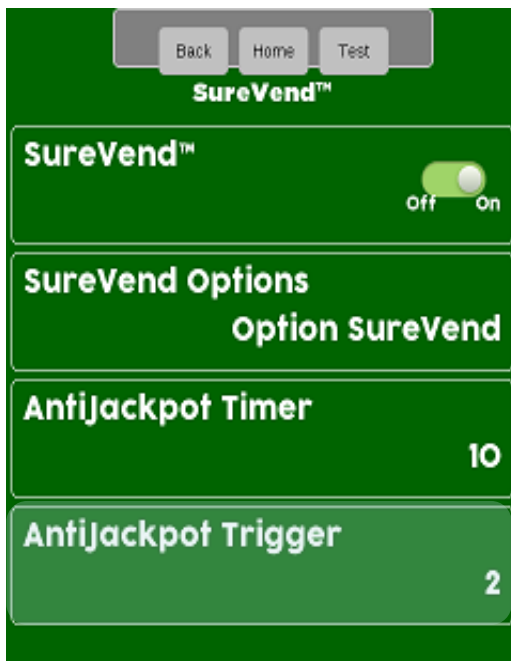



Product Configuration

Couple Motors

Touch Couple Motors to enter the Menu.

Choose a tray you want to Couple Motors on.

All available selections that can be coupled are shown. Touch a menu bar to add a checkmark to the selections to be coupled. In some cases there may be a down arrow on the right side of the key pad to scroll to additional selections.

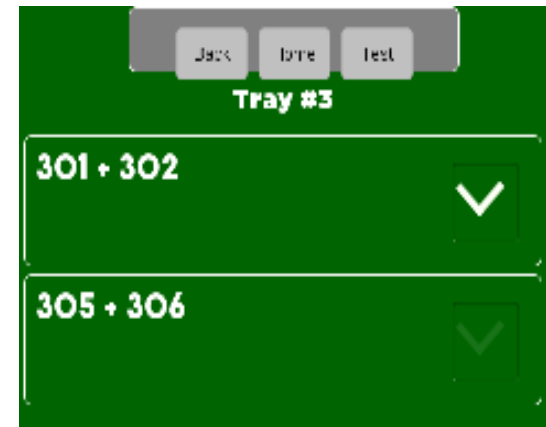
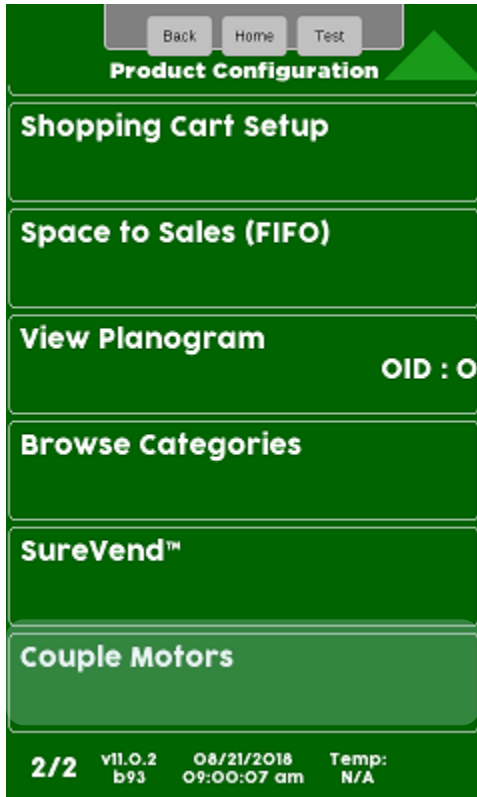

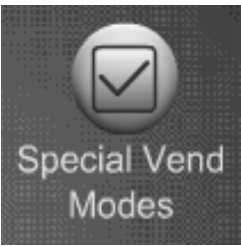

Special Vend Modes

Special Vend Modes provides access to:

- Alternative Vending
- Free Vend
- Token Enable
- Winner Mode
- Combo Vend
- Token Enable
- Rapid Vend
- Skip Main Menu
- MultiVend Discount

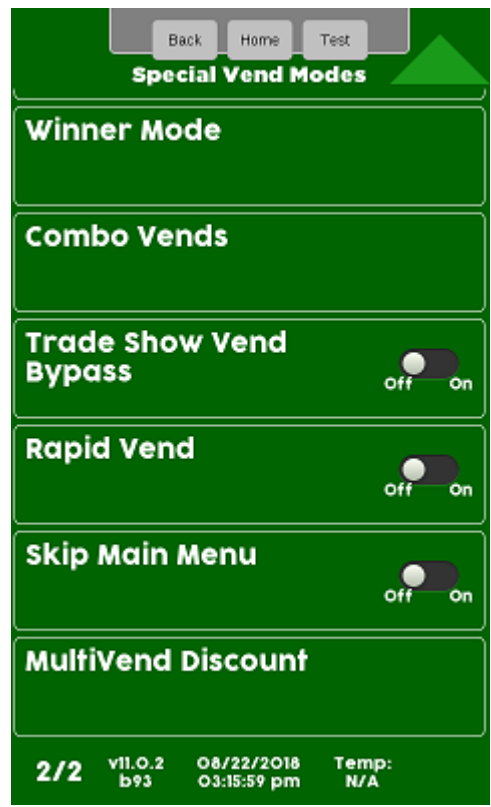
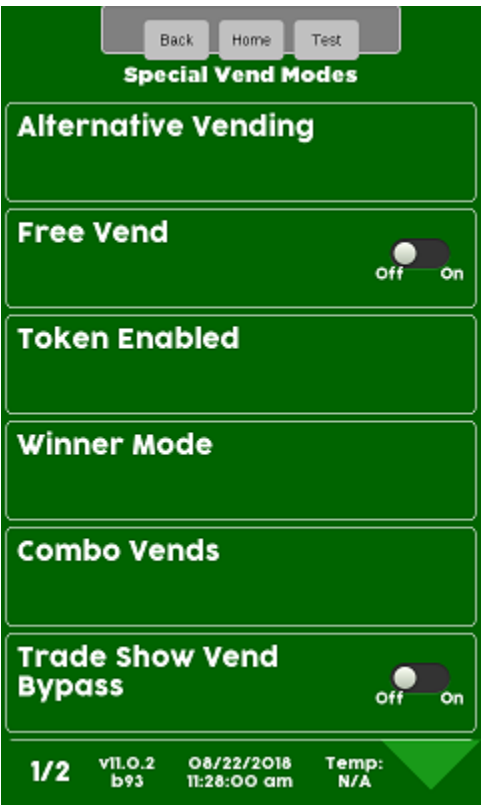

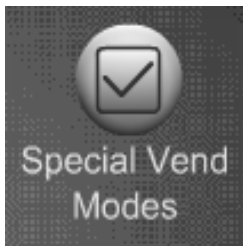

Special Vend Modes

Free Vend

Press Alternative Vending to access the Alternative Vending options

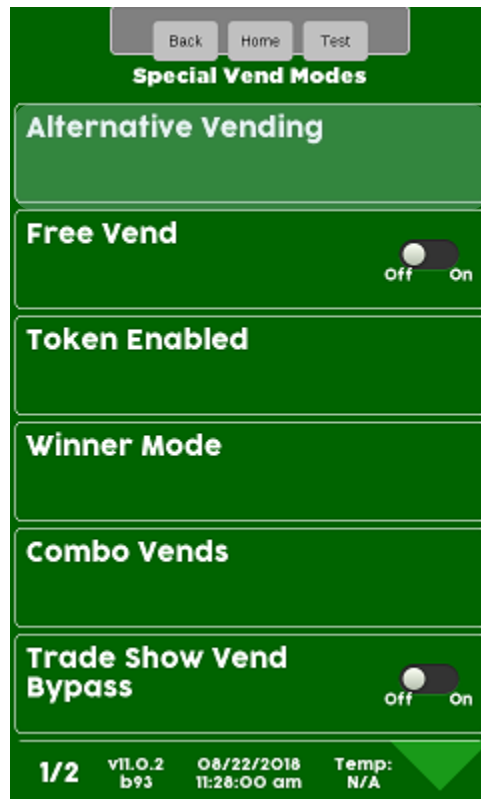

This Menu gives you the option to hide pricing and cart totals as well as to empty the shopping cart upon failure of a transaction. Both can be turned On or Off by touching the menu bar below to toggle the setting.

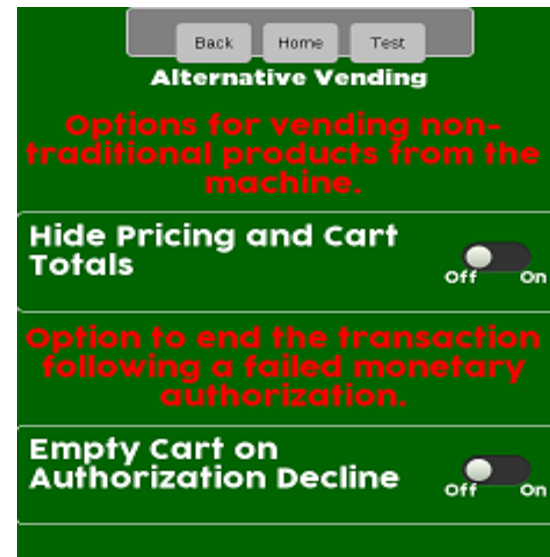

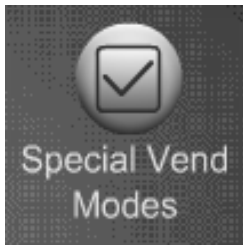

Special Vend Modes

Free Vend

Free Vend

- Touch Free Vend to toggle the free vend setting between OFF and ON.
- When set to ON all items will be free until turned off.

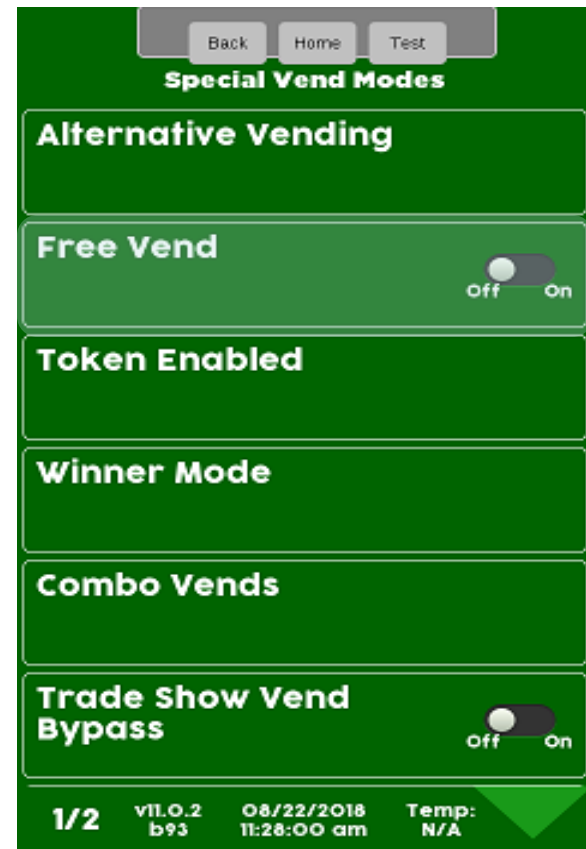

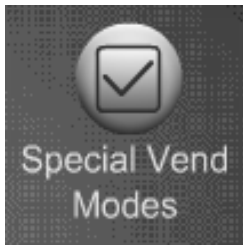

Special Vend Modes

Token Enable

Token Enable

- This Menu allows you to choose the selections the customer is permitted to purchase with Tokens or Coupons.
- *Note: Tokens must be enabled in the Monetary menu under Bill Acceptance for Tokens or Coupons to work.*
- Your Coin Mechanism or Bill Acceptor must be tuned and/or configured to accept your Token or Coupon.

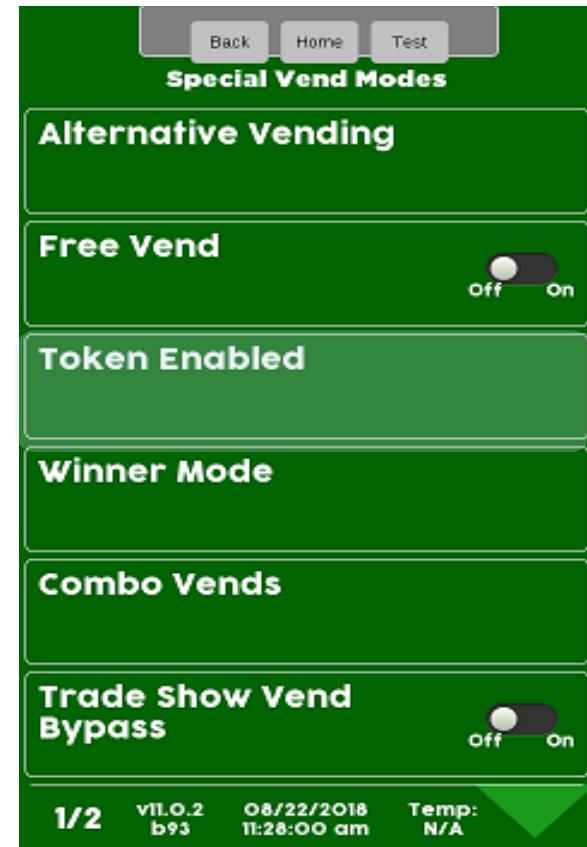

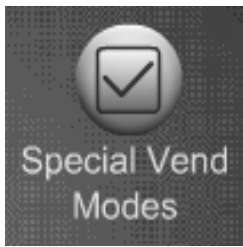

Special Vend Modes

Token Enable

Touch Token Enabled to assign selections to work with Tokens/Coupons

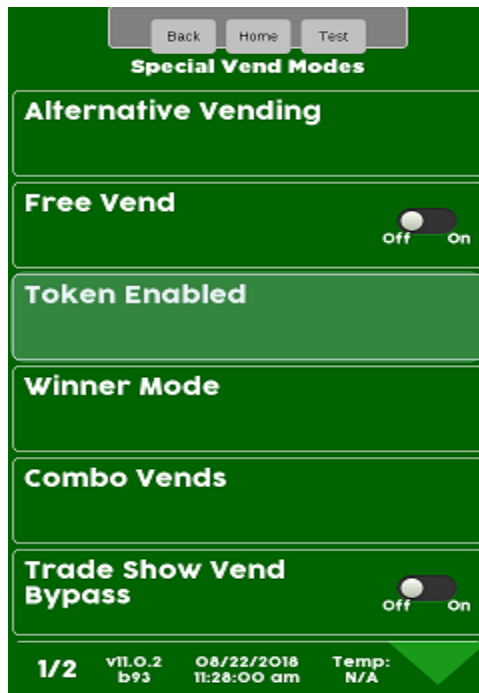

Select the tray to assign selections to work with Tokens/Coupons. You can also select all (entire machine) or clear all selections.



Touch Select All, Clear All or individual selections to add a checkmark to the selections that you want to work with Token/Coupons

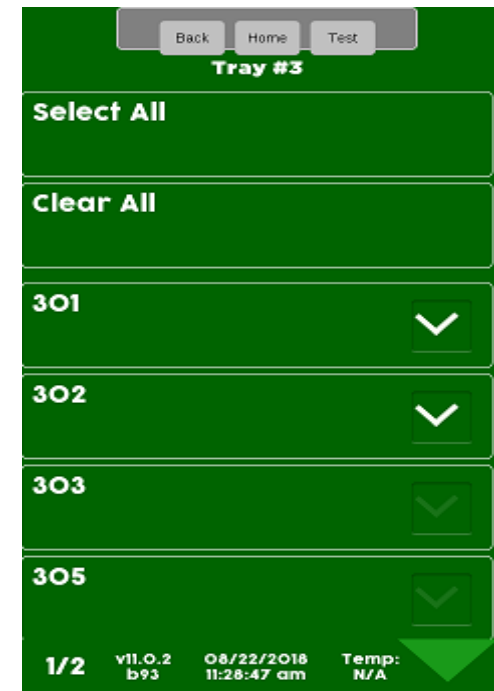

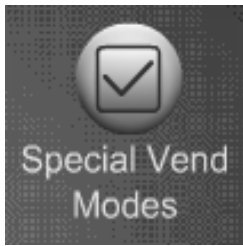

Special Vend Modes

Winner Mode

Winner Mode

When Winner Mode is turned on:

- The customer will receive their product and get their money back or an additional item (programmable) at no charge.
- The display will prompt the customer if they are a winner.
- The frequency of a winner is programmable.

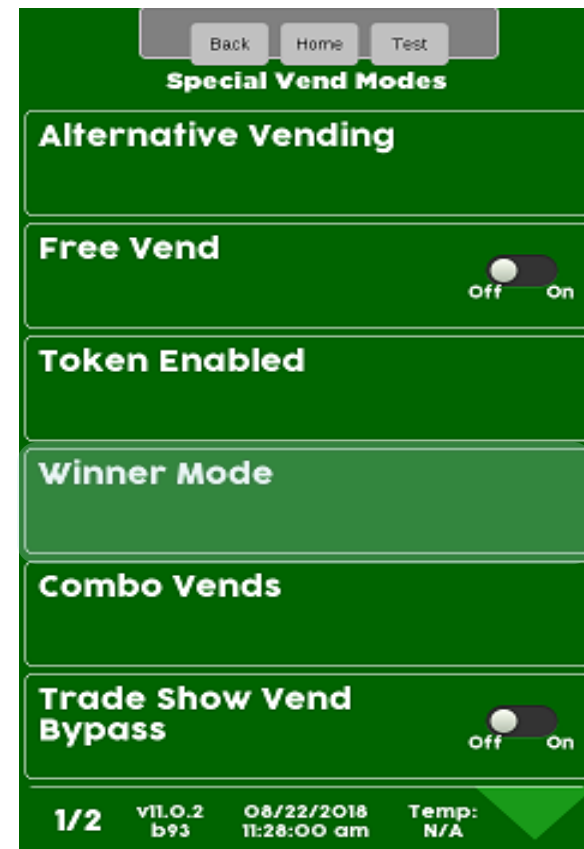

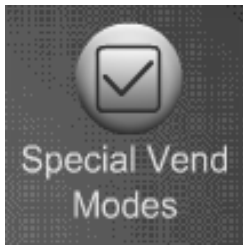

Special Vend Modes

Winner Mode

Winner Mode

By touching a menu bar on the screen you can:

- Add a Group
- Delete a Group
- Edit a Group
- View the current selections assigned to a Winner Group



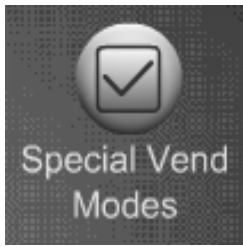

Special Vend Modes

Winner Mode – Add a Group

Adding a New Winner Group:

- To add a New Winner Group you must first set the Mode, Frequency, Prize and Selections that are to be part of the group.
 - Once selections are set, Touch Add a New Winner Group to create the Group
- Note: You will not be allowed to add a new group without assigning selections first.*

The screenshot shows a mobile application interface for adding a new group. At the top, there are three buttons: "Back", "Home", and "Test". Below them is the title "Add Group". The screen is divided into several sections:

- Save Group**: A large green button.
- Mode**: A field with the value "prize".
- Frequency**: A field with the value "0".
- prize**: A field with the value "101".
- By UPC**: A toggle switch currently set to "Off".
- Selections**: A field with the value "Nothing Selected".

At the bottom of the screen, there is a status bar with the following information: "1/2", "v11.0.2 b93", "08/22/2018 12:04:11 pm", and "Temp: N/A".

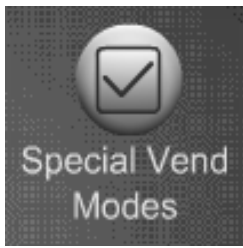

Special Vend Modes

Winner Mode – Add a Group

Touch Mode to toggle between Prize and Winner. If set to Winner the customer will receive their money back based on the frequency set

If set to Prize, another menu item will appear on the display. This is where you choose the item the customer will win based on the frequency set.

Back Home Test

Add Group

Save Group

Mode prize

Frequency 0

prize 101

By UPC off On

Selections Nothing Selected

1/2 v11.0.2 b93 08/22/2018 12:04:11 pm Temp: N/A

Mode

winner

prize

Accept Cancel

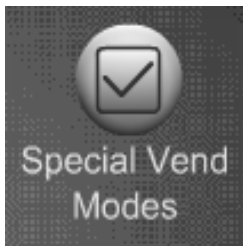

Special Vend Modes

Winner Mode – Add a Group

Touch Frequency to choose how often a customer will be a winner.

The screenshot shows the 'Add Group' screen with the following fields and controls:

- Buttons: Back, Home, Test
- Section: **Add Group**
- Field: **Save Group**
- Field: **Mode** prize
- Field: **Frequency** 0
- Field: **prize** 101
- Field: **By UPC** with a toggle switch set to 'off' (On)
- Field: **Selections** Nothing Selected
- Footer: 1/2, v11.0.2 b93, 08/22/2018 12:04:11 pm, Temp: N/A

Use the keypad to enter the Frequency of a winner and press Accept. If you set it to 50 every 50th person is a winner. If set to 1 everyone is a winner.

The keypad interface shows the following elements:

- Label: **Frequency : 0**
- Keypad grid:

1	2	3
4	5	6
7	8	9
C	0	⊗
- Buttons: **Accept** (green), **Cancel** (red)

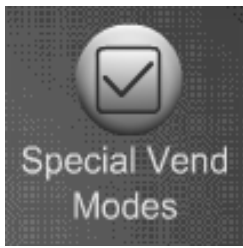

Special Vend Modes

Winner Mode – Add a Group

Touch Prize to enter the selection number that will contain the prize. This menu will not be shown if winner was selected instead of prize.

Use the keypad to enter the selection number that will contain the prize and press Accept to save.

The screenshot shows a green-themed menu titled "Add Group". At the top are three buttons: "Back", "Home", and "Test". Below the title are several sections: "Save Group" (empty), "Mode" (set to "prize"), "Frequency" (set to "0"), "prize" (set to "101"), "By UPC" (with a toggle switch currently in the "off" position), and "Selections" (set to "Nothing Selected"). At the bottom, there is a status bar with "1/2", "v11.0.2 b93", "08/22/2018 12:04:11 pm", and "Temp: N/A".

The screenshot shows a keypad interface for selecting a prize. At the top, it says "prize : 101". Below this is a 4x3 grid of buttons: the first row contains "1", "2", "3"; the second row contains "4", "5", "6"; the third row contains "7", "8", "9"; and the fourth row contains "C", "0", and a delete icon (a square with an 'X'). At the bottom of the keypad are two buttons: "Accept" (green) and "Cancel" (red).

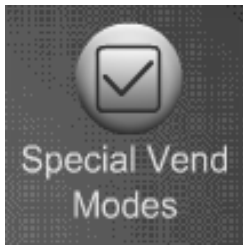

Special Vend Modes

Winner Mode – Add a Group

Leaving the By UPC toggle in the off position will cause the menu bar below it to say selections and you can choose which selection will be active for this winner event.

The screenshot shows the 'Add Group' screen with the following fields and values:

- Buttons: Back, Home, Test
- Section: Add Group
- Save Group: [Empty field]
- Mode: prize
- Frequency: 0
- prize: 101
- By UPC: Off (toggle is in the off position)
- Selections: Nothing Selected
- Footer: 1/2, v11.0.2 b93, 08/22/2018 12:04:11 pm, Temp: N/A

Changing the By UPC toggle to the On position will cause the menu bar below it to say by UPC and you can choose which UPC codes will be active for this winner event.

The screenshot shows the 'Add Group' screen with the following fields and values:

- Buttons: Back, Home, Test
- Section: Add Group
- Save Group: [Empty field]
- Mode: prize
- Frequency: 0
- prize: 0
- By UPC: On (toggle is in the on position)
- UPC/EAN Codes: Nothing Selected
- Footer: 1/2, v11.0.2 b93, 08/22/2018 03:37:47 pm, Temp: N/A

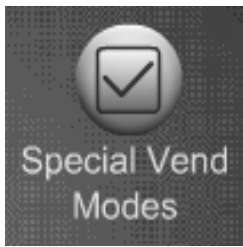

Special Vend Modes

Winner Mode – Add a Group

If using selection numbers for this event touch the selections menu bar

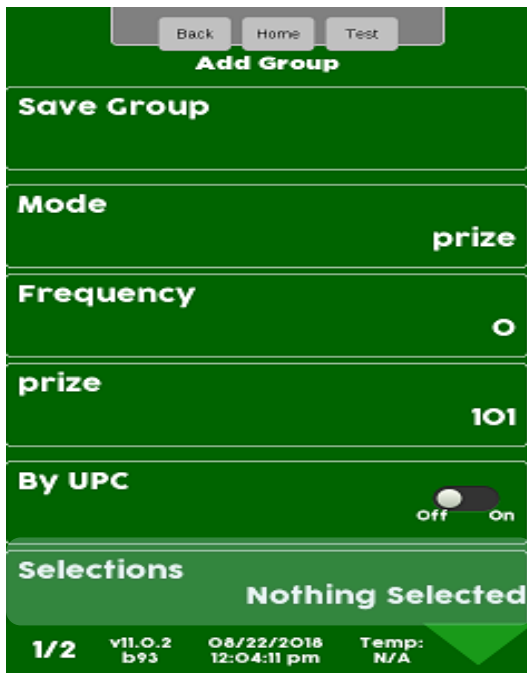

Choose a tray for items you want to initiate the Event



Touch the menu bar to Select All, Clear All or add a checkmark to the selections to work with Winner Mode. Press Back to exit and choose another tray to add selections to if desired.

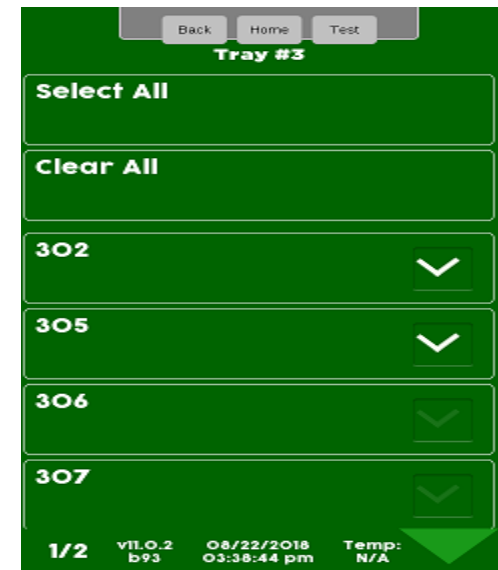

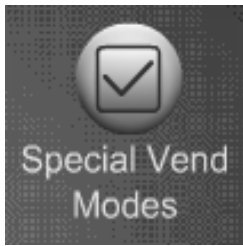

Special Vend Modes

Winner Mode – Add a Group

Save your work!

After entering your Parameters and selections for Winner Mode you must touch Add New Winner Group. If you do not touch Add New Winner Group before exiting, your settings will not be saved!

The screenshot shows a green-themed interface for adding a group. At the top, there are three buttons: "Back", "Home", and "Test". Below them is the title "Add Group". The main content area consists of several sections:

- Save Group**: A large green button.
- Mode**: A label with the value "prize" on the right.
- Frequency**: A label with a radio button on the right.
- prize**: A label with the value "101" on the right.
- By UPC**: A label with a toggle switch on the right, currently set to "Off".
- Selections**: A label with the text "Nothing Selected" on the right.

At the bottom, there is a status bar with the following information: "1/2", "v11.0.2 b93", "08/22/2018 12:04:11 pm", and "Temp: N/A".

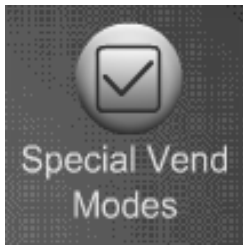

Special Vend Modes

Winner Mode – Delete a Group

Touch Delete a Group



Touch group to Delete



Touch Yes to confirm or No to cancel



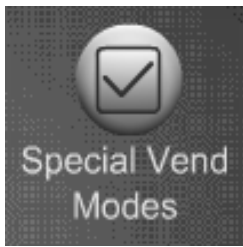

Special Vend Modes

Winner Mode – Edit a Group

Touch Edit a Group



Touch the Promotion you wish to Edit



Touch the item you wish to Edit. **Save the changes when you are done editing by selecting Save Group!**

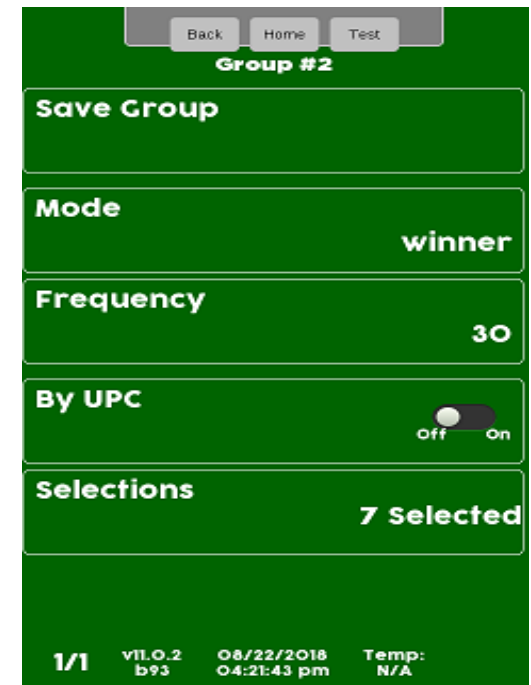

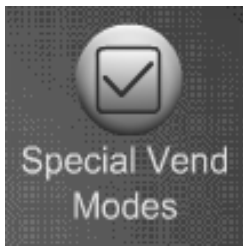

Special Vend Modes

Winner Mode – Winner Selections Assigned

Touch Winner Selections Mappings to view selections currently assigned to Winner Groups.



Touch the tray you wish to View.



The display will show you what groups each selection on the tray is assigned to.

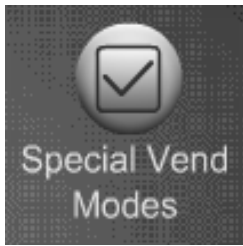

Special Vend Modes

Combo Vend

Combo Vend

- The Combo Vend Menu allows you to set up a selection to be offered in conjunction with another selection.
- A combo vend can be a combination of two or three products.
- All products in a combo vend can be discounted or just the last item.
- Items can be discounted by a value or percentage.
- Touch Combo Vend to access the Combo Vend set up mode.

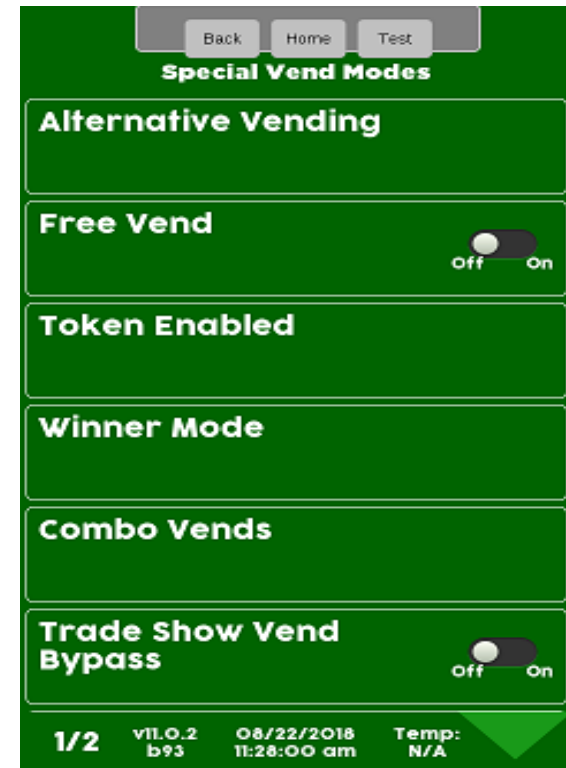

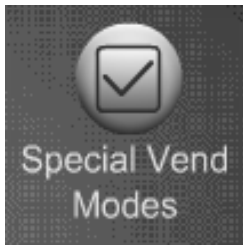

Special Vend Modes

Combo Vend

How Combo Vend Works

1. Select the first item and place it in the “Shopping Cart” by pressing the shopping cart icon.
2. Select the second item and place it in the “Shopping Cart”, if a third item is part of the Combo Vend it must be placed in the cart also.
3. Insert money and press Check Out.
4. All items in the cart will be delivered.
5. The discount will be displayed and returned as change.

Rules for setting up Combo Vend

- The Rapid Vend feature must be set to NO, so that the “Shopping Cart” function is activated.
- Both “Shopping Cart” Value & number of items must be set high enough to accommodate the needs of the Combo Vend Promotion.
- Two items from the same group will not get a discount.
- For two of the same item to be discounted that item must be in group 1 & 2.

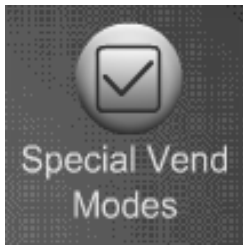

Special Vend Modes

Combo Vend

The Combo Vend Menu allows you to:

- Add a new Combo Vend.
- Delete an existing promotion.
- Edit an existing promotion.
- View the existing selections set for a Combo Vend promotion.

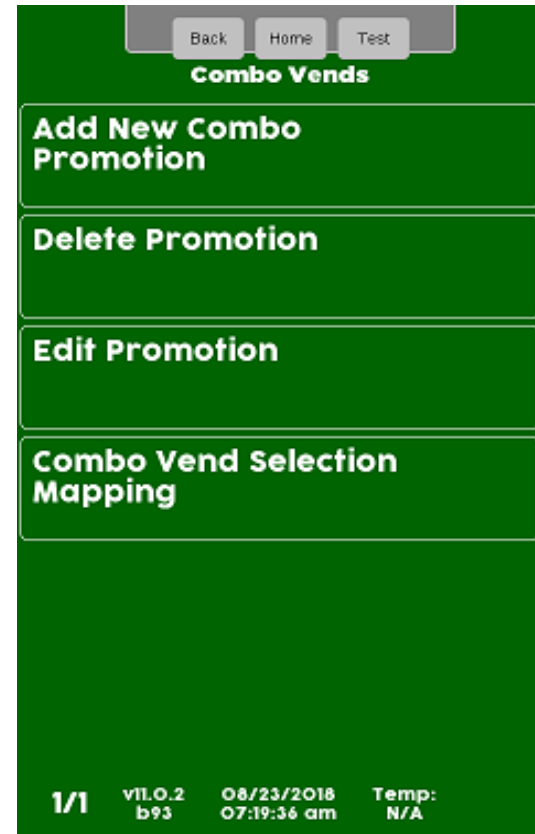

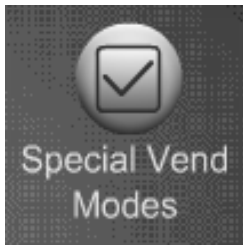

Special Vend Modes

Combo Vend – Add a New Combo Vend

Touch Add New Combo Promotion

Note: You must set up your combo vend options before you can save them by touching Add New Combo Promotion. See the step by step instructions on the following pages.

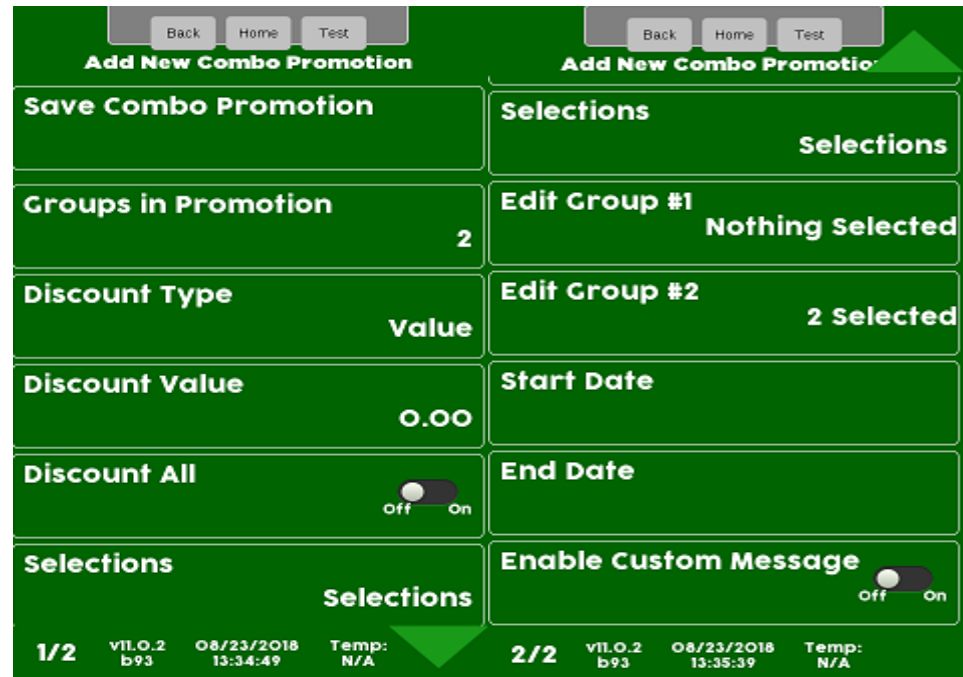

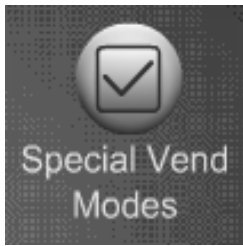

Special Vend Modes

Combo Vend – Add a New Combo Vend

You can choose to have 2 or 3 selections as part of a combo vend group. Touch Number of Groups in Promotion to toggle between 2 and 3. If you choose 3, the customer must buy three items that are part of the group for the discount to apply.

Press Accept to Save

Groups in Promotion	2
Groups in Promotion	
2	
3	
Accept	Cancel

Use the keypad to enter the type of discount by choosing Value, Percentage or Price. The screen in the previous menu will change to reflect choice of discount type.

Press Accept to save.

Discount Type	Value
Discount Type	
Value	
Percent	
Price	
Accept	Cancel

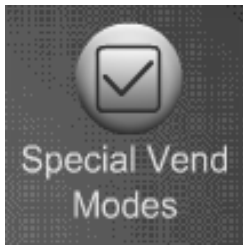

Special Vend Modes

Combo Vend – Add a New Combo Vend

Touch the Discount Value, Percent or Price menus bar to set the discount amount

Use the keypad to enter the amount of the discount by value Percent or price based on what was chosen in the previous menu Press Accept to save.

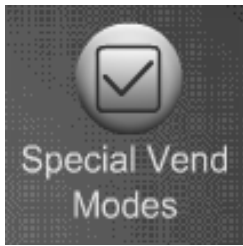

Special Vend Modes

Combo Vend – Add a New Combo Vend

Discount All

- Touch Discount All to toggle between ON and Off.
- If you choose **On** all items that are part of a combo vend group will all be discounted by the amount set.
- If you choose **Off** only the last item in the discount group will be discounted.

The screenshot shows a green-themed mobile application interface for adding a new combo promotion. At the top, there are three buttons: "Back", "Home", and "Test". Below them is the title "Add New Combo Promotion". The screen is divided into several sections:

- Save Combo Promotion**: A large green button.
- Groups in Promotion**: A green box with the number "2" on the right.
- Discount Type**: A green box with the word "Value" on the right.
- Discount Value**: A green box with "0.00" on the right.
- Discount All**: A green box with a toggle switch. The switch is currently in the "Off" position, with "Off" and "On" labels below it.
- Selections**: A green box with "Selections" on the right and a green downward-pointing arrow.

At the bottom of the screen, there is a status bar with the following information: "1/2", "VII.O.2 b93", "08/23/2018 13:34:49", and "Temp: N/A".

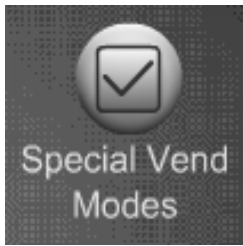

Special Vend Modes

Combo Vend – Add a New Combo Vend

Combo Vends can be set up by selections (default) or UPC codes. Choose the Selections menu bar to change between Selections and UPC Code. The current choice is shown on the bottom right of the menu bar.

Touch the menu bar on the screen to choose Selection or UPC. Press Accept to save.

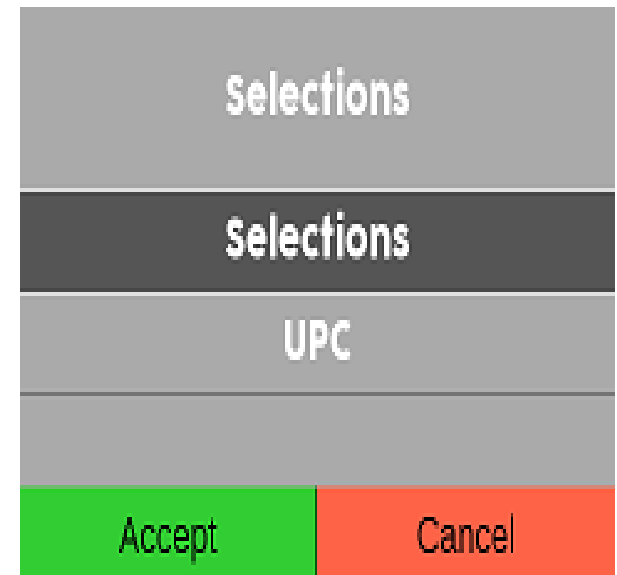
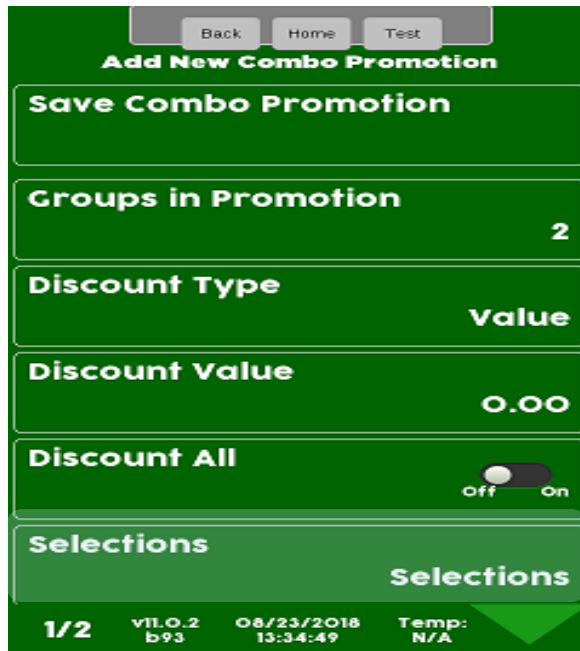

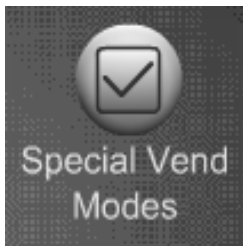

Special Vend Modes

Combo Vend – Add a New Combo Vend

Touch the menu bar set selections for group one, group two and group three. Group 3 will only appear if the number of groups is set to three.

Back Home Test

Add New Combo Promotion

Edit Group #1
Nothing Selected

Edit Group #2
Nothing Selected

Edit Group #3
Nothing Selected

Start Date

End Date

Enable Custom Message Off On

2/2 v11.0.2 b93 08/23/2018 17:06:01 Temp: N/A

Choose the tray or trays that contain selections to be added to the group.

Back Home Test

Edit Group #1

Tray #1

Tray #2

Tray #3

Tray #4

Tray #5

Tray #6

1/2 v11.0.2 b93 08/23/2018 17:06:14 Temp: N/A

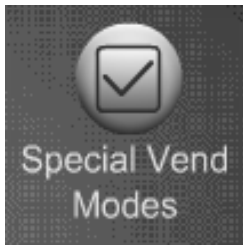

Special Vend Modes

Combo Vend – Add a New Combo Vend

- To add all selections on the tray to the group Touch Set All.
- To remove all selections on the tray from the group Touch Clear All.
- Touch any selection number to add or remove a checkmark from that selection. A checkmark means that selection will be active for the Combo Vend group.
- In some cases there will be a down arrow on the right side of the screen, touching it will allow you to scroll down to additional selections on the shelf that do not fit on the screen.
- Press the Back button to exit and choose another tray to add selections to if desired.

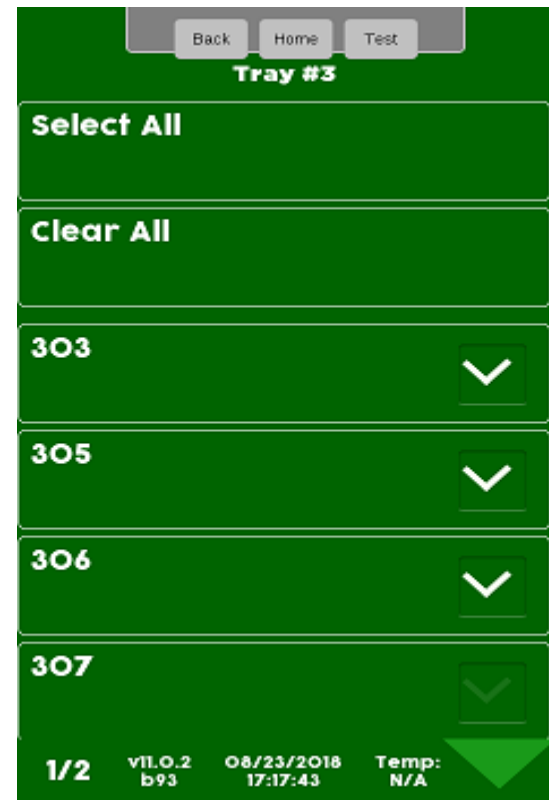

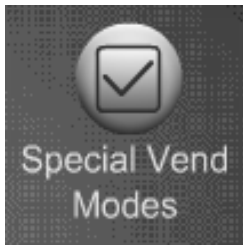

Special Vend Modes

Combo Vend – Add a New Combo Vend

Touch the Menu bar to enter a Start Date and End Date for the Combo Vend. A start date must be entered. If no End date is entered the combo vend will not end.

Enter the Start Date or end date as selected on the menu bar pictured to the left. The date should be entered as selected in the time date menu. In the US that is MM/DD/YYYY.

Back Home Test

Add New Combo Promotion

Edit Group #1
Nothing Selected

Edit Group #2
Nothing Selected

Edit Group #3
Nothing Selected

Start Date

End Date

Enable Custom Message
off On

2/2 v11.0.2 b93 08/23/2018 17:06:01 Temp: N/A

Start Date : 08/23/2018

1	2	3
4	5	6
7	8	9
C	0	⊗

Accept Cancel

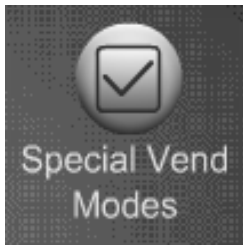

Special Vend Modes

Combo Vend – Add a New Combo Vend

After entering all option & times for all groups Press the Back button to go back to the screen on the right.

If you are setting a custom message for Combo vends continue to the next screen.

Important: If you are not setting a custom message, be sure to save your Combo Vend settings by Selecting Add New Combo Promotion. If you fail to do so your settings will not be saved! You must have selections added into all groups before you can save by touching Add New Combo Promotion.

Back Home Test

Add New Combo Promotion

Save Combo Promotion

Groups in Promotion 2

Discount Type Value

Discount Value 0.00

Discount All off on

Selections Selections

1/2 v1.0.2 b93 08/23/2018 13:34:49 Temp: N/A

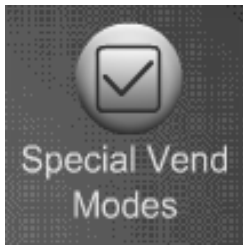

Special Vend Modes

Combo Vend – Enable Custom Message

Touch Enable Custom Message to toggle On to set a custom message. This message will be displayed when Combo Vend is active.

A keypad will appear on the screen along with a window to enter the Message. Use the keypad to enter the Message. Press Accept when finished

Back Home Test

Add New Combo Promotion

Edit Group #1 Nothing Selected

Edit Group #2 Nothing Selected

Edit Group #3 Nothing Selected

Start Date

End Date

Enable Custom Message off on

2/2 v11.0.2 b93 08/23/2018 17:06:01 Temp: N/A

Message :

a	b	c	d	e	f	g
h	i	j	k	l	m	n
o	p	q	r	s	t	u
v	w	x	y	z	ABC	
123	abc	#@		C	⊗	←

Accept Cancel

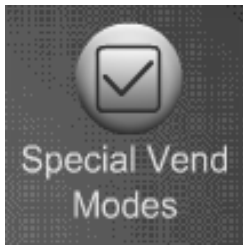

Special Vend Modes

Combo Vend – Enable Custom Message

After entering your custom message and touching done the display will switch back to the screen on the right.

Important: Save your Combo Vend settings by touching Add New Combo Promotion. If you do not save your settings they will be gone!

The screenshot shows a green-themed interface for adding a new combo promotion. At the top, there are three buttons: "Back", "Home", and "Test". Below them is the title "Add New Combo Promotion". The main content area consists of several sections: a large green button labeled "Save Combo Promotion"; a section titled "Groups in Promotion" with the value "2"; a section titled "Discount Type" with the value "Value"; a section titled "Discount Value" with the value "0.00"; a section titled "Discount All" with a toggle switch currently in the "Off" position; and a section titled "Selections" with the value "1/2". At the bottom, there is a status bar with the text "v11.0.2 b93", "08/23/2018 13:34:49", and "Temp: N/A". A green arrow points down from the "Selections" section.

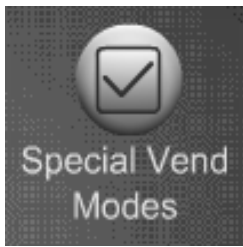

Special Vend Modes

Combo Vend – Delete Promotion

Touch Delete an existing promotion

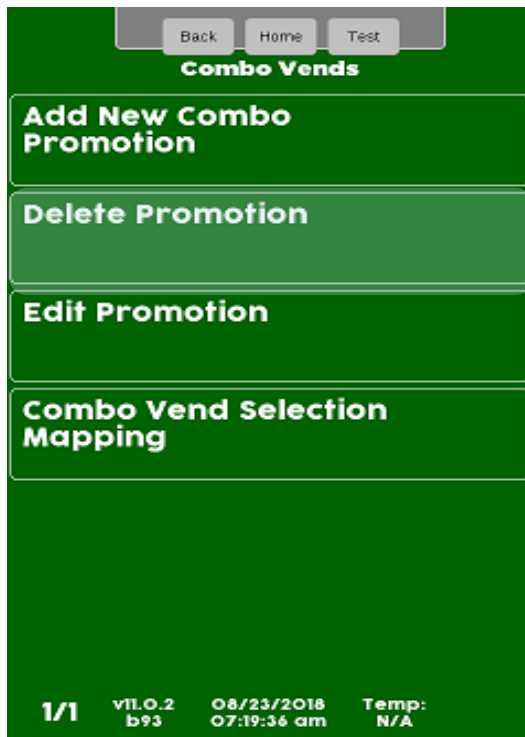

Select the promotion to Delete

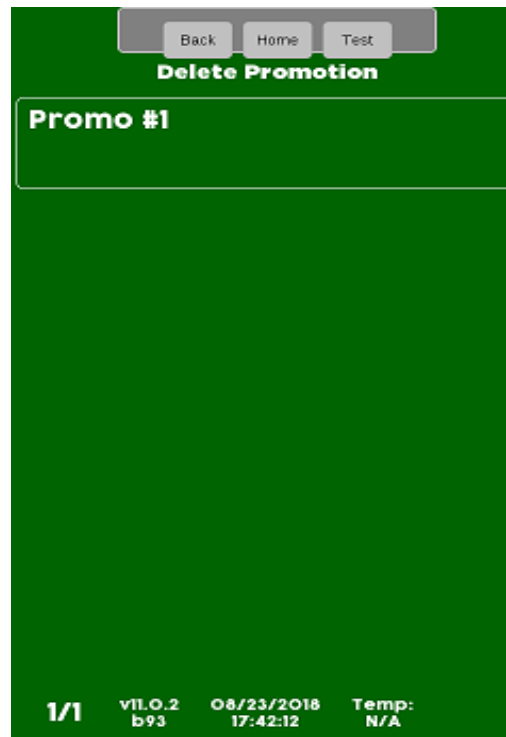

Press YES to confirm or NO to cancel

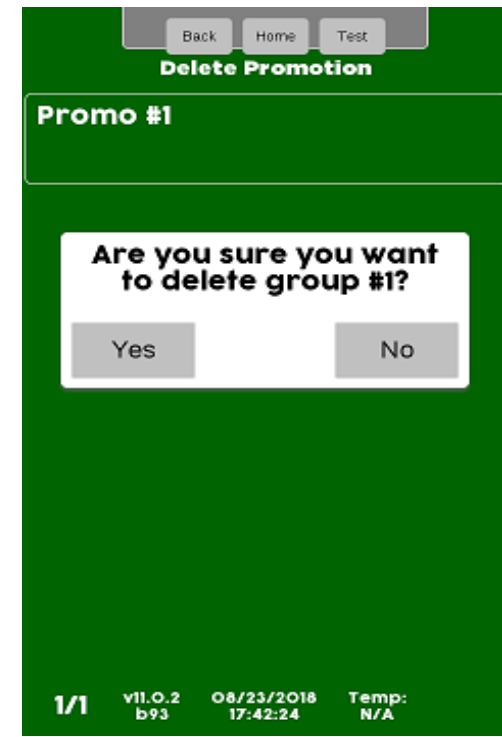

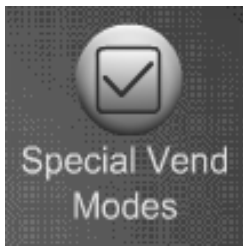

Special Vend Modes

Combo Vend – Edit Promotion

Touch Edit Promotion

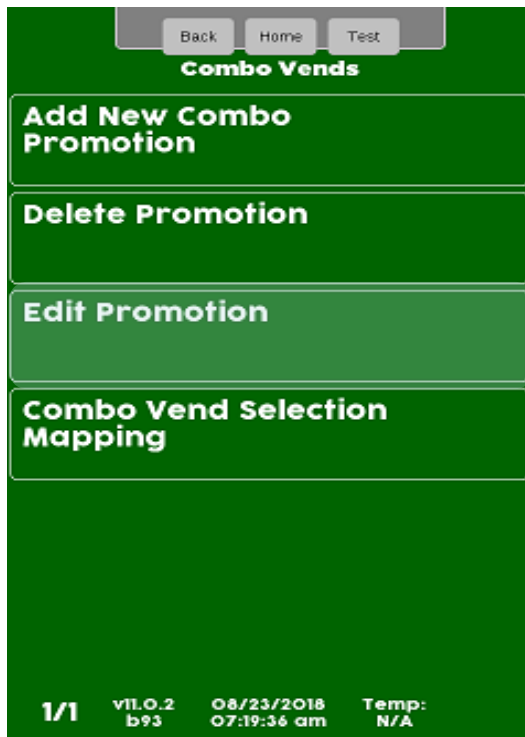

Select the promotion you want to Edit.



Select the item you wish to Edit. **Save the changes when you are done Editing by pressing Save Promotion.**

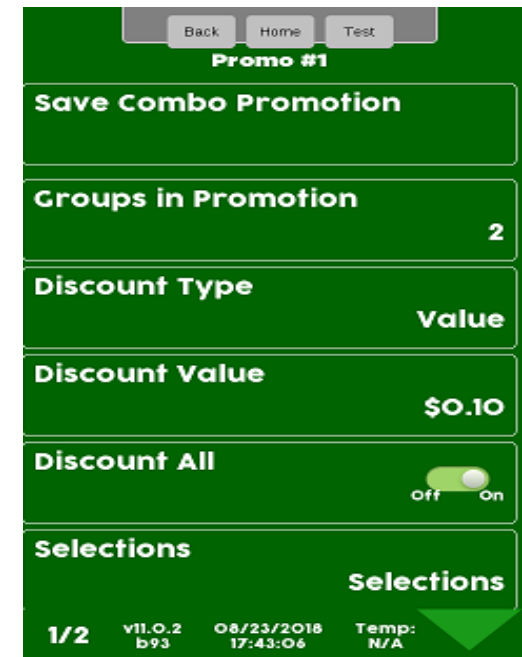

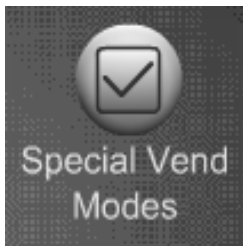

Special Vend Modes

Combo Vend – View Selection Mapping

Touch Combo Vend Selection Mapping to view selections currently assigned to a combo Vend

Select the tray you wish to View

The display shows each selection/UPC on the tray and the promo # it is assigned to.

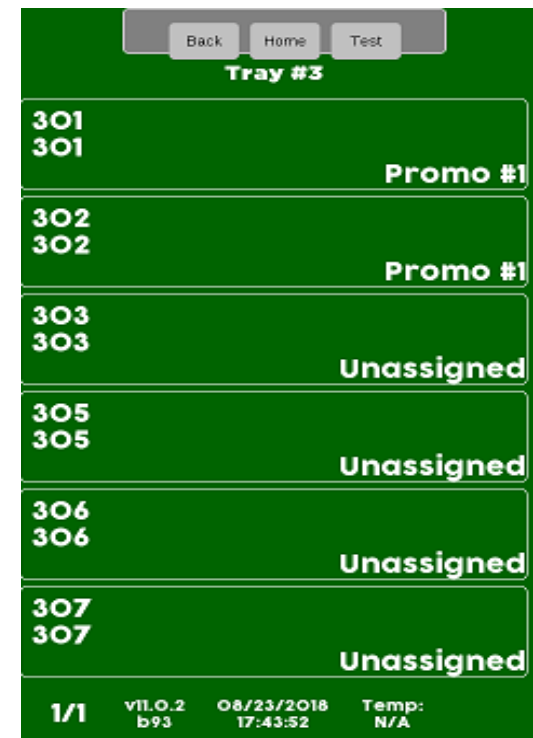

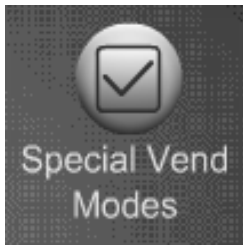

Special Vend Modes

Rapid Vend

Rapid Vend Mode

- When Rapid Vend Mode when set to On the machine will work as a single vend only merchandiser.
- The product will vend as soon as a selection is made without touching Purchase.
- Touch Rapid Vend to toggle between Off and On

Note: The shopping cart is automatically disabled when Rapid Vend is turned on, and will prevent consumers from making multiple selections during a single transaction.

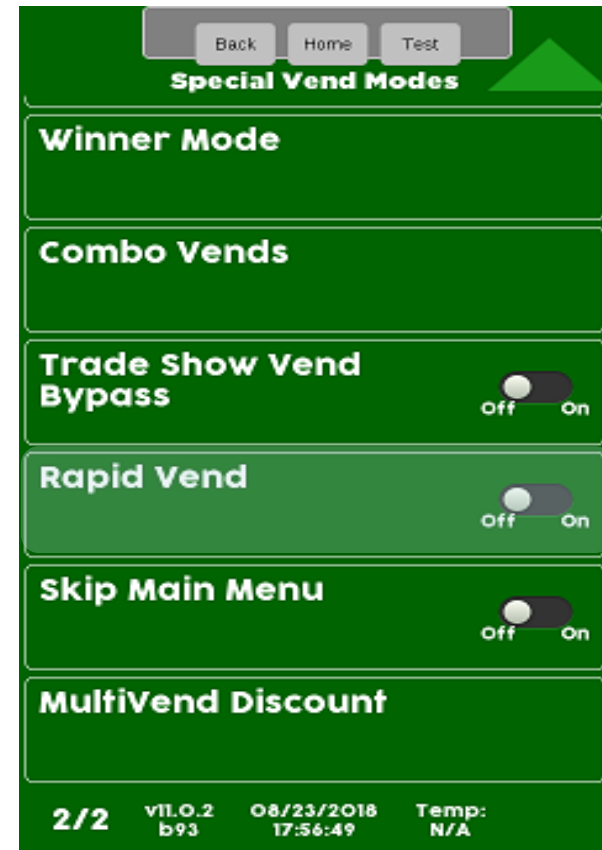

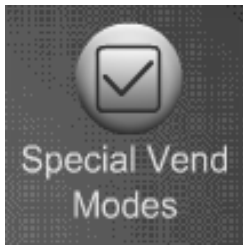

Special Vend Modes

MultiVend Discount

MultiVend Discount

- When MultiVend Discount is set to YES all selections in the shopping cart with two or more items are discounted by the percentage specified.
- This discount applies to all selections and is not settable by specific selections.
- This discount, once enabled, will be on until it is turned off, it is not settable by time of day or days of week.
- If you want to set specific selection combinations to be discounted or discounts by time of day see the Combo Vend or Timed Events Menus in this guide.

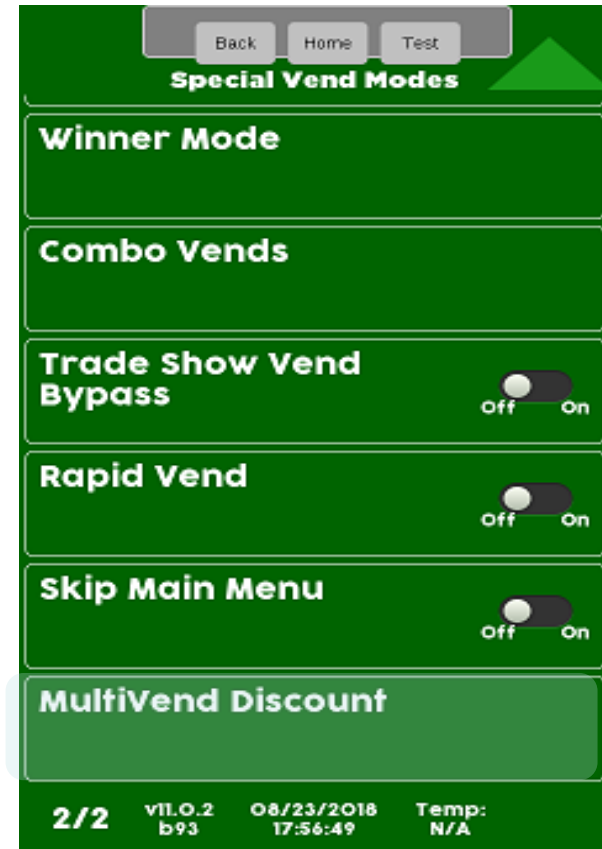

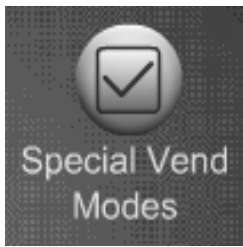

Special Vend Modes

MultiVend Discount

Touch the Multi-Vend Discount Enable menu bar to toggle to On.

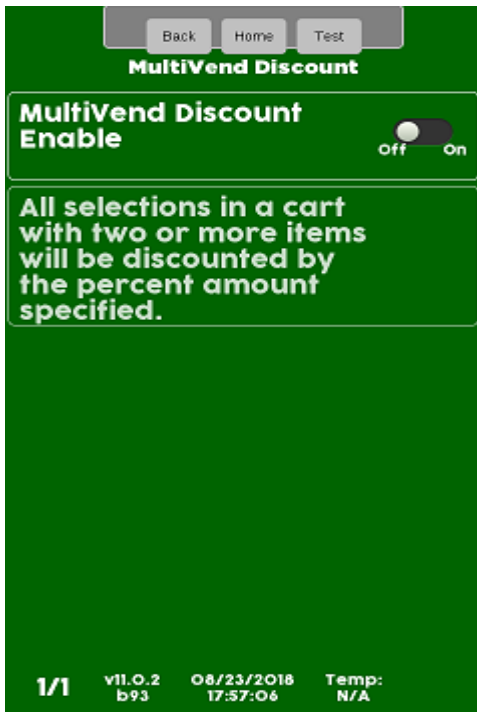

A Percent Discount menu bar will appear. Touch the menu bar to change the Percentage of the Discount.

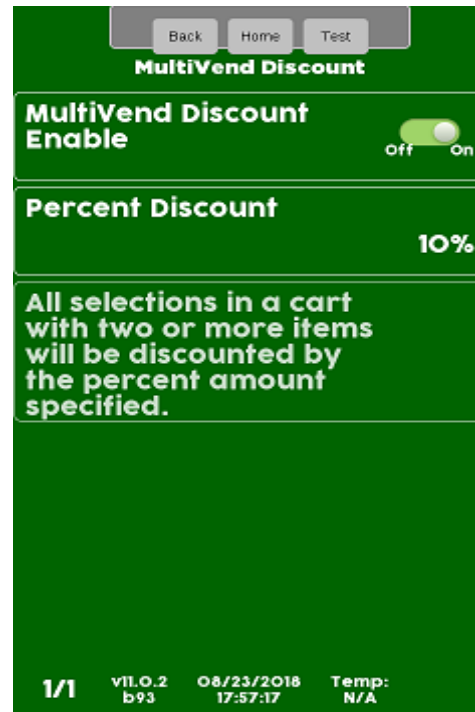

Use the keypad to enter a new discount percentage. Press Accept when finished.

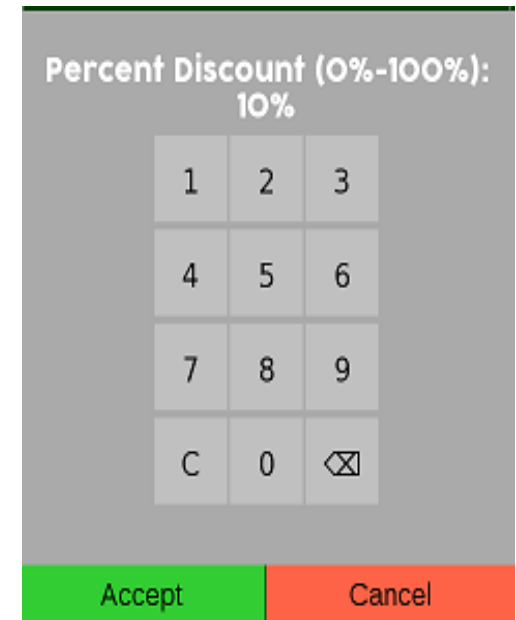



Security Codes

The Security code menu

- The first menu allows you to enter an existing PIN number to access other menus.
- The second and third menus allows you to change the existing PIN numbers.
- The Route Driver Price Menu allows price changing using the Driver Pin
- **Warning:** If you change the PIN, don't forget it, you won't be able to access the Service Mode.

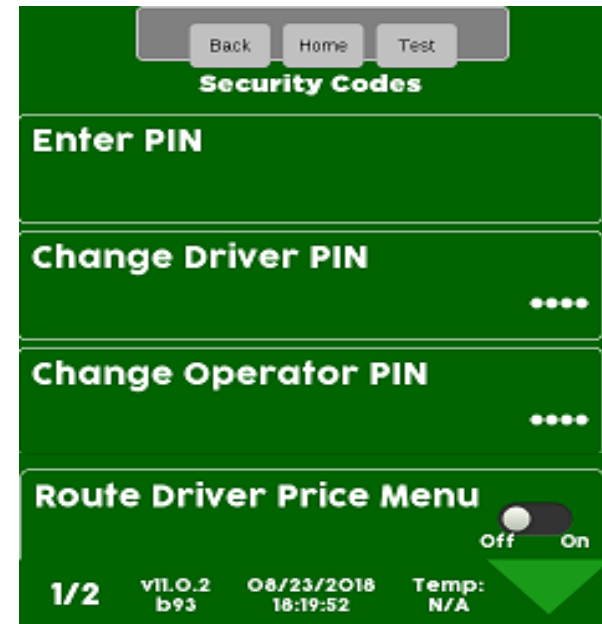



Security Codes

Enter Pin

Touch Enter the existing pin

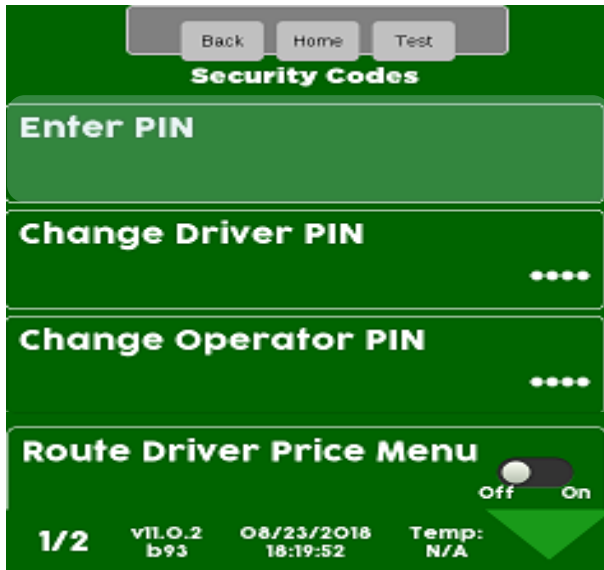

The Pin screen will appear, enter your existing PIN.





Security Codes

Change Driver or Operator Pin

Touch a menu bar to change the existing Driver or Operator PIN number

Enter your new Pin Number using the keypad. Touch Done when finished!

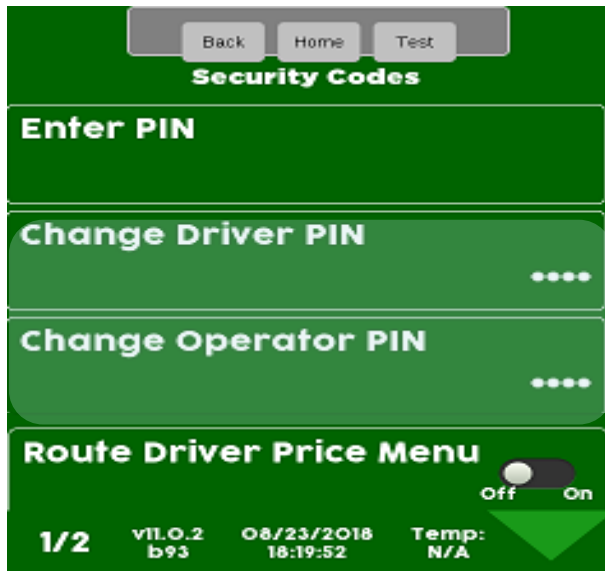



Security Codes

Enter Pin

Touch the Route Driver Price Menu Bar to toggle between Off and ON. The Route Driver Price Menu adds a menu bar that allows price changing using the Driver Pin.

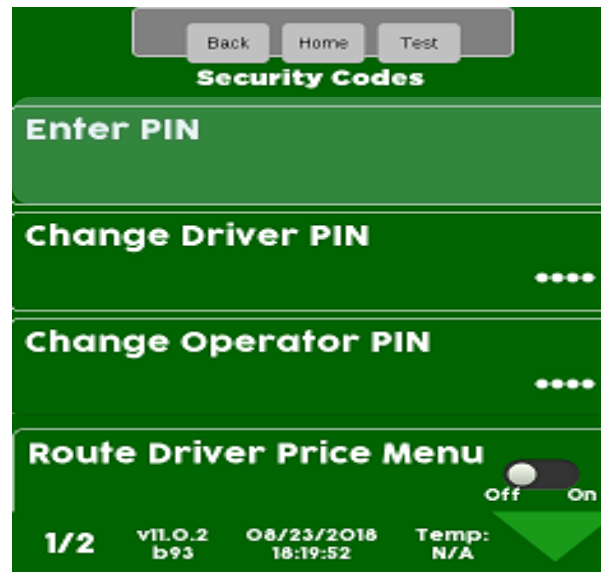



Firmware Information

Touching Firmware on the keypad brings up an information screen that displays the following information:

- All the MDB peripherals in the machine including manufacturer, serial number and software version.
- The software version of the SureVend™ board.
- The software version of the I/O board.
- The software version of the Atlas (LE) board.
- The serial number of the Atlas control board, along with the software version, and kernel file version.
- If Crane cashless is used it will also show the Processor, Customer account number and code.

The screenshot shows a green-themed interface with a top navigation bar containing 'Back', 'Home', and 'Test' buttons. The main title is 'Firmware Information'. Below this, there are four sections:

- OTA/USB Activity**: A section header.
- Cashless**: A section header.
- Monetary**: A table listing device details.
- Machine Information**: A table listing system details.

At the bottom, there is a status bar with '1/1', 'v11.0.2 b93', '08/23/2016 18:57:50', and 'Temp: N/A'.

Device	Model Number	Software Version
Bill Validator	MAG52R -1	0001
Coin Mechanism	USQ712R01 AE1	0008
Card Reader A	--/--	--/--
Card Reader B	--/--	--/--

Kernel	4.1.15+AUTOINC+bc53e94fd9
Software Version	20180213121316
I/O Board Version	0227
Board Serial Number	300006677



Telemetry

The Telemetry Menu is used to set up your:

- Integrated Wireless Radio
 - Cashless
 - Remote DEX Alerts
 - Mesh Network.
- The Telemetry Menu also allows you to send a DEX file on demand in addition to the scheduled times.
 - Driver Cards are available to send a DEX read when servicing the machine, or you can send a DEX from this menu or the Driver Menu (pin 1111) has a Send DEX icon.

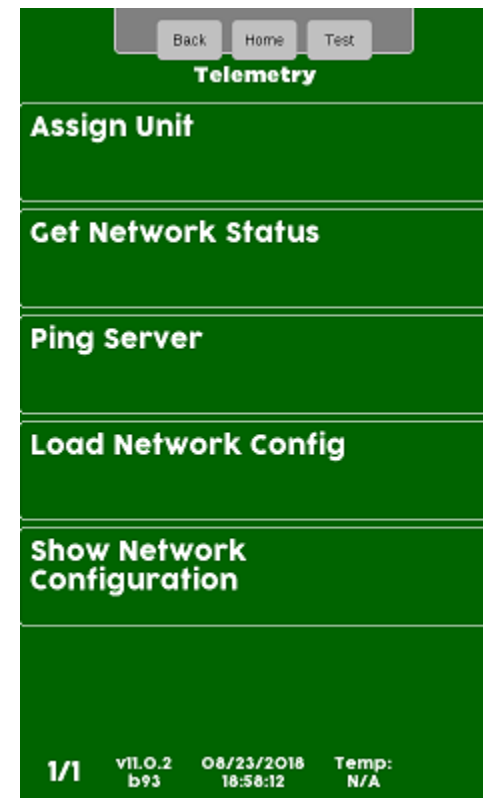



Telemetry

Assigning Unit

Assigning a Unit

Before assigning the unit, you must establish an account with the card processor and Crane Streamware. All of the information and Applications are included in the Welcome packet that came with the machine. If you have any questions, contact your Crane Distributor or Sales Person.

- When the customer account is established, Crane Streamware will email the customer configuration (VIX) file to upload and assign the Merchant Media.
- Create a folder on your USB flash drive named atlas. Copy your VixConfigData.cfg file to this folder.

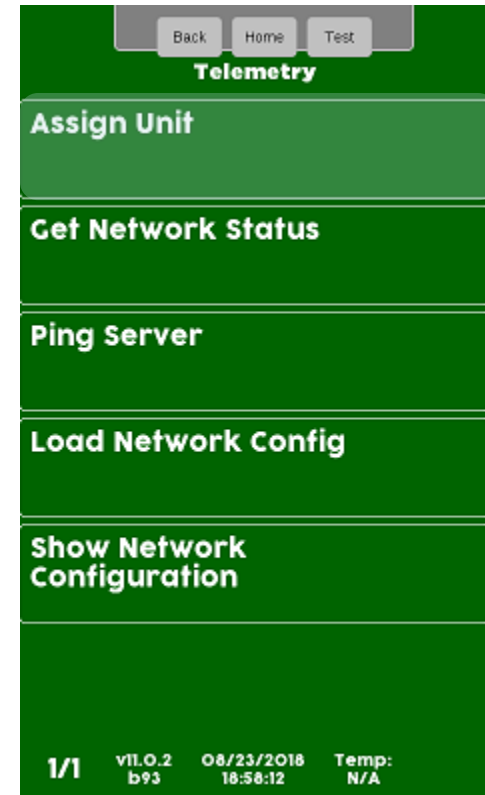



Telemetry Assigning Unit

Verify the radio is connected to USB1 (top Left USB port). USB1 is the high-power USB port.

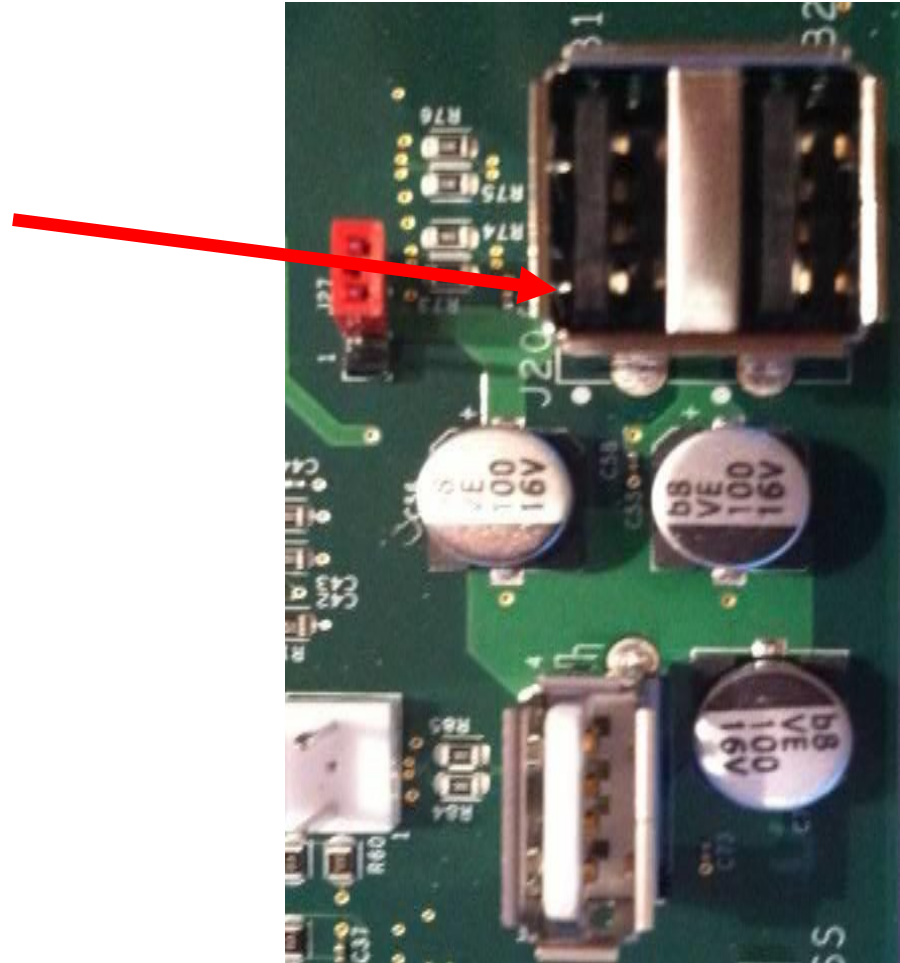



Telemetry Assigning Unit

Access the service mode
by entering PIN 3333

Insert the Flash Drive with the
VixConfigData.cfg file into
USB 3 on the control board

Touch Telemetry on the
screen

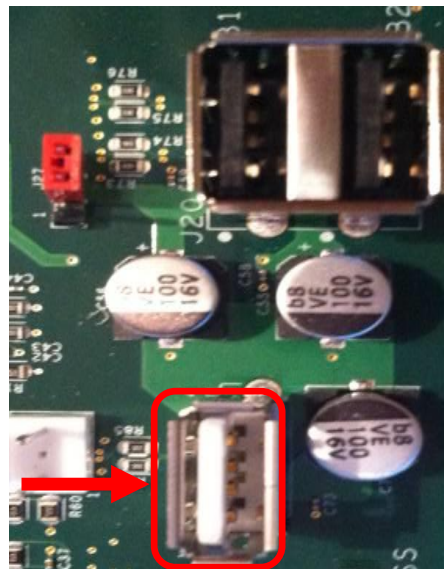



Telemetry

Assigning Unit

Touch Assign Unit, the display will show you the available Vix file (accounts information) on the flash drive and prompt you to choose that file or choose another.

The machine will prompt you to identify the machine by entering a machine ID using the keypad below and pressing Accept

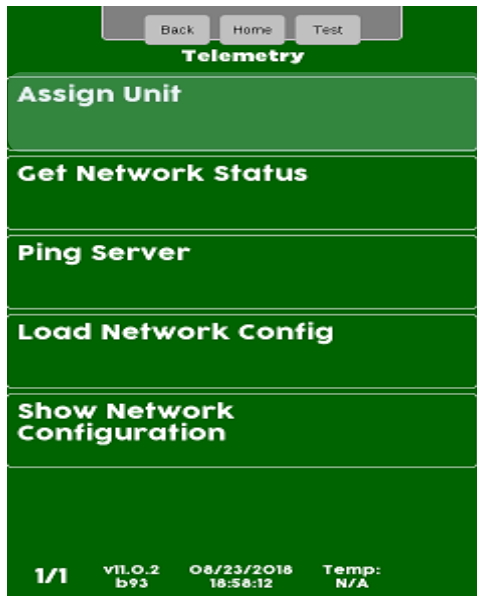



Telemetry

Get Network Status

To view the current network status touch Get Network Status.

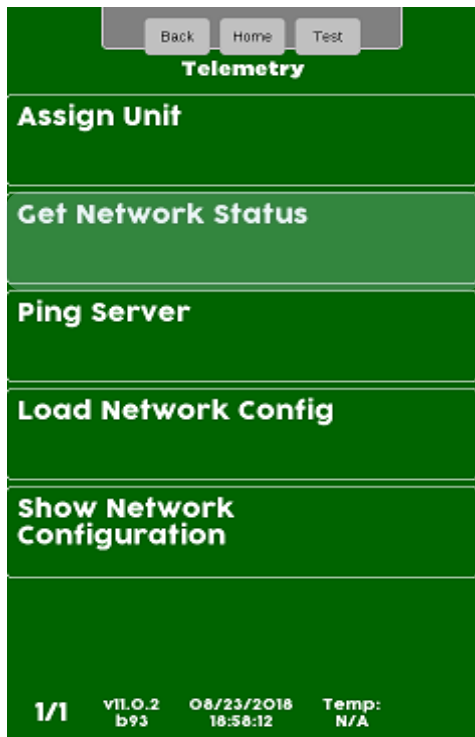

The screen will show the current Network Status.





Telemetry Ping Server

Touch Ping Server to
Ping the Server.

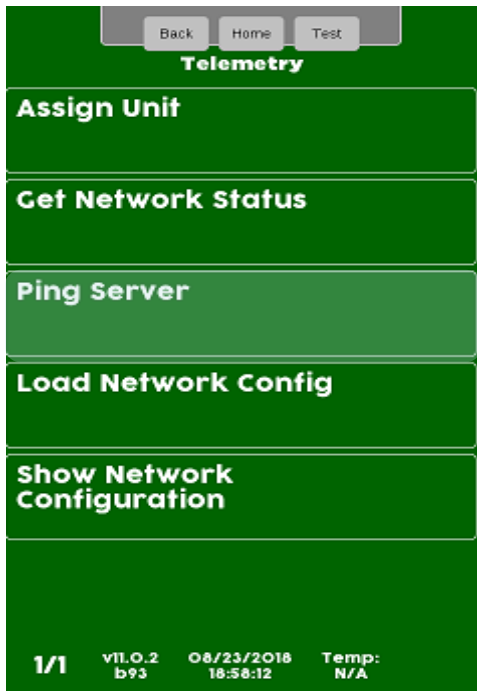

The results will display on
the screen

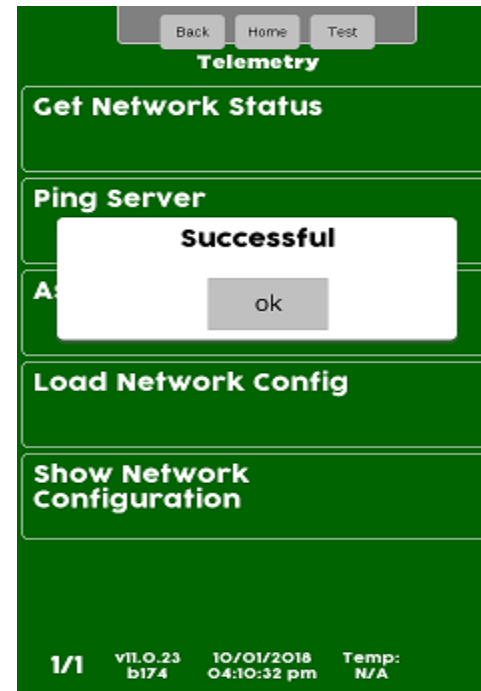



Telemetry

Load Network Configuration

Touch Load Network Config

The results will be shown
on the Screen

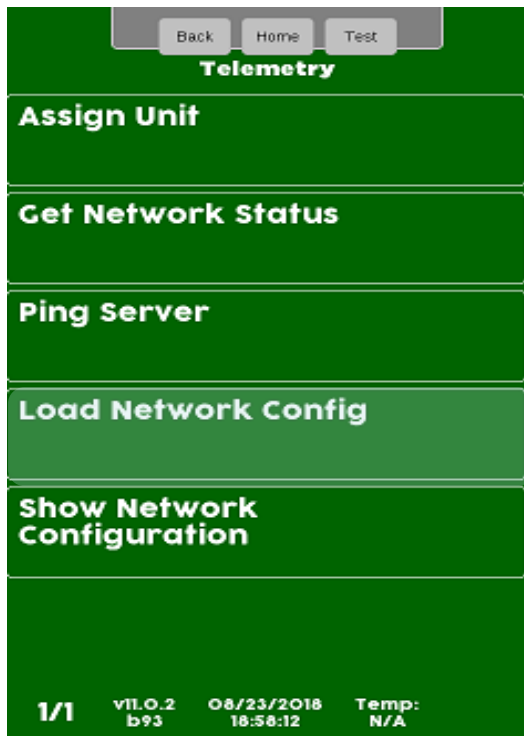



Show Network Configuration

Touch Show Network Config

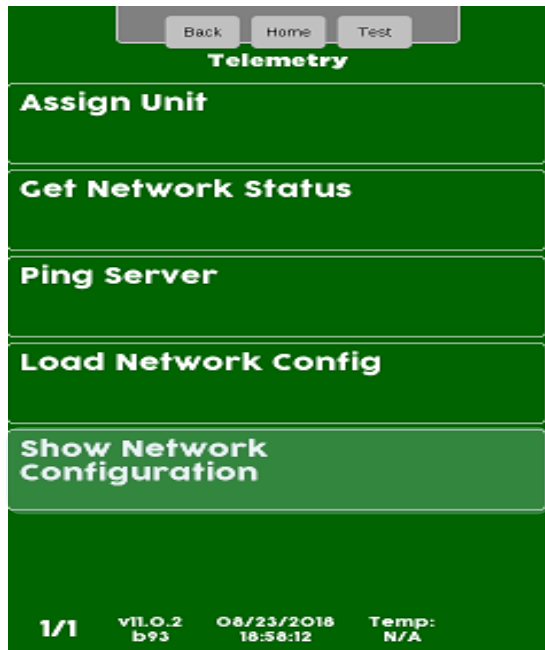

The Current Network Configuration will be shown on the display





Telemetry Enable Mesh

Mesh Networking

- The Mesh Module is mounted on the top left corner of the Atlas Controller.
- Mesh uses a proprietary wireless network that CMS uses to communicate to other Mesh devices.
- This network is used for Telemetry device, Client to Gateway communication.
- Mesh allows machines in a area with bad cellular signals to send information to a host machine with a radio, the Host machine becomes a Gateway to send & receive the information for the group of machines.
- Mesh can also communicate with any machine that has Navigator installed which includes a Mesh module.

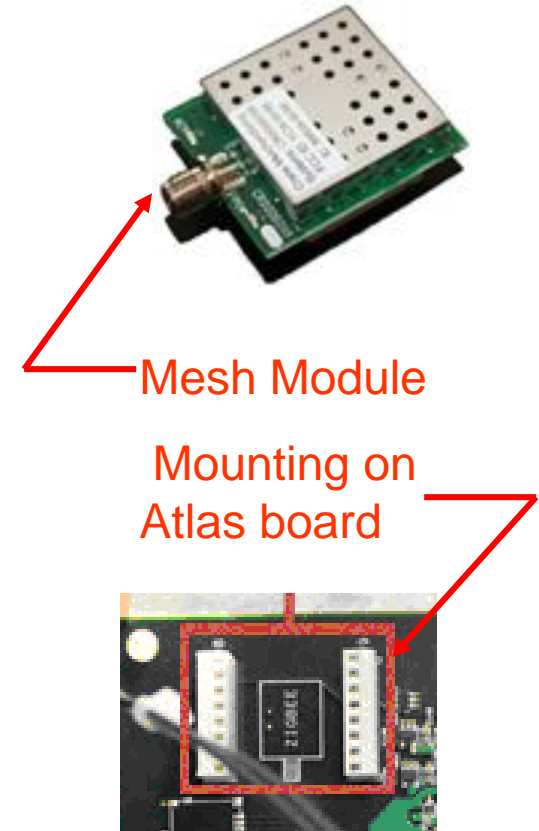

Mesh Module

Mounting on
Atlas board



Diagnostics Menu

- Touching the Diagnostics Icon will cause the Diagnostics screen to appear. This screen will show any existing errors along with time and date the errors occurred.
- The Icon will be Red when there are errors, otherwise it will be gray.
- The Diagnostics screen automatically appears when entering the service mode if errors exist.
- The errors do not need to be cleared, when an error is corrected it will automatically be deleted from the error list.
- The reason for showing Last Reboot and the Uptime Since Last Reboot are also shown for informational and troubleshooting purposes.
- If the error screen is full, a down arrow will appear on the bottom right side of the screen allowing the user to scroll down to a second screen of errors.

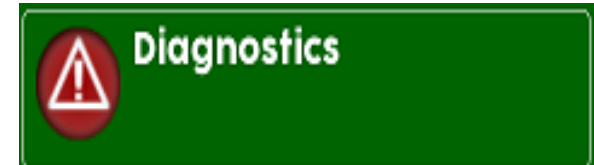

Back Home Test

Diagnostics

Active Errors

Event ID	time	date
SV NF Comm Error	08:29 am	02/14/2018
Use exact change	08:29 am	02/14/2018
Coin Tube 0 Empty	08:29 am	02/14/2018

Last Reboot Reason
no recent event

Uptime Since Last Reboot
0 hours 4 minutes

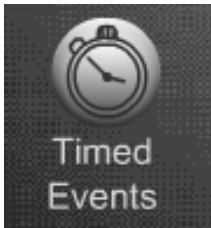

Timed Events

Timed Events Menu allows you to:

- Create Time of Day Events including Promotions.
- Backup your Current Events
- Create Power Saving Events
- Create Suggestion Engine Events

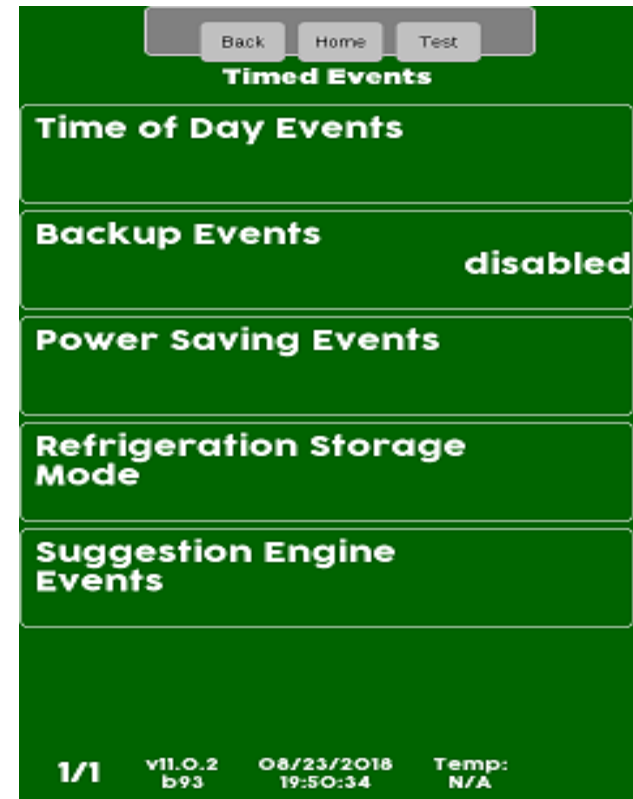

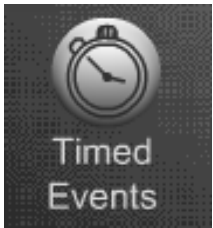

Timed Events

Time of Day Events

Time of Day Events

- When you choose Time of Day Events the following four options will appear on the screen.
 - Price Adjust
 - Free Vend
 - Inhibit
 - Promotions

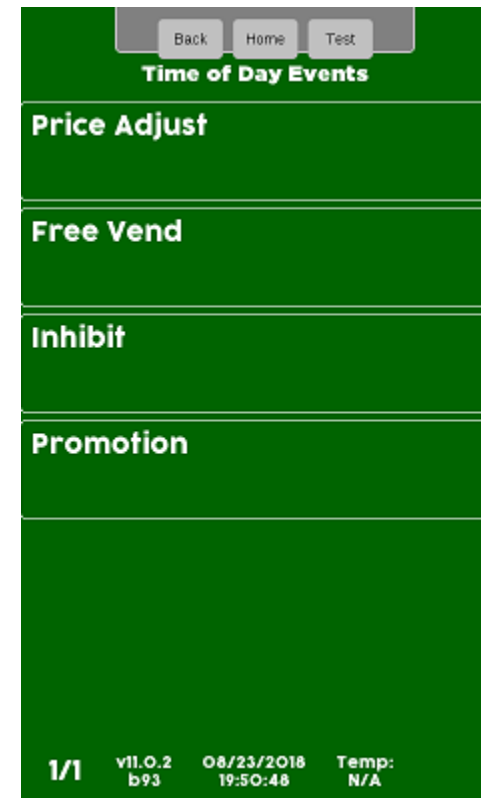

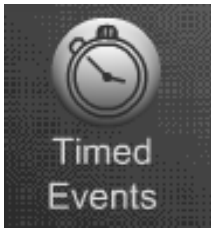

Timed Events

Time of Day Events – Order of Precedence

- Timed events are arranged in an order of precedence, in other words, one has priority over another.
- The hierarchy of Time of Day events is:
 1. Inhibit
 2. Free Vend
 3. Promotion
- This means that if an Inhibit Event affecting all selections is active, and a Free Vend event or a Promotion event are scheduled, when the Inhibit event is scheduled, the Free Vend and the Promotion event are temporarily disabled until the end of the Inhibit event.
- There are other settings within the machine that could affect the value of the discount provided. If you find that the discount amount appears incorrect, check these settings.
 - Multi-Vend Discount is located in the Special Vend Mode menu, and is a percentage discount provided to a customer for purchasing multiple items in a single transaction
 - Cash Discount is located in the Monetary menu, and provides a defined cash discount to customer who purchase a selection using cash (coins, bills or stored value card) instead of a credit card.

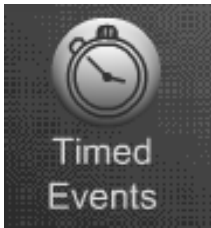

Timed Events

Helpful Tips

Helpful Tips

- All events will not have the same menus. As an example, a Price Adjust Event will have a discount feature that a Power or Backup event would not have.
- In some cases some menus will not be present until another menu is enabled.
- Events are settable daily or weekly. When daily is chosen you choose the days of the week so the event **must not cross over midnight**. As an example, if you were to set a power event from 10:00 PM to 6:00 AM that would be two separate events. The first from 10:00 PM to 11:59 PM and the second from 12:00 AM to 06:00 AM.
- All Events will have a Save This Event menu bar. This is used to save the event after you have set all the other menus in an event. Save your changes frequently.
- If your event has a large menu that continues on to a second screen, **use the up and down arrow key to scroll back up to the first screen to Save**. If you use the exit key you will lose any changes and be starting over.

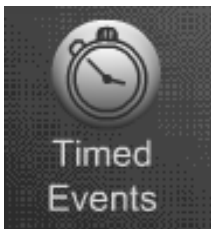

Time of Day Events – Price Adjust

Price Adjust

- The Price Adjust menu allows you to set times and/or day(s) when the prices will adjust automatically.
- The menu bars on the right contain all the options that need to be set and may change depending on your selections.
- Price adjustments can be set by value or discount by changing the Price Adjust Type.
- Price adjust has one menu that is not used in any other event, that menu is:
- Price Adjust Type – This menu allow you to set to either Discount or Surcharge for the event.
- **Save your changes often by choosing save this event. If you exit without choosing save this event your changes will be lost!**

Back Home Test

Create Price Adjust Event

Save This Event

Remove This Event

Enable State Off On

Price Adjust Type
Discount Percent

Discount Percent
0%

Frequency
Daily

1/3 v11.O.2 b93 08/23/2018 19:51:15 Temp: N/A

Back Home Test

Create Price Adjust Event

Start Date
01/01/1974

End Date
12/31/2050

Start Time
00:00

Stop Time
00:00

Days of Week

By UPC Off On

Selections
nothing selected

2/3 v11.O.2 b93 08/23/2018 20:02:15 Temp: N/A

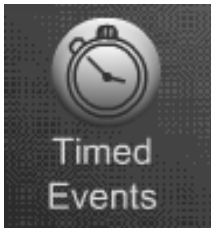

Timed Events

Time of Day Events – Free Vend

Free Vend

- The Free Vend menu allows you to set a time and/or day(s) when the Machine will go on Free Vend automatically.
- The menu bars on the right contain all the options that need to be set up for your event and may change depending on your selections.
- You can choose the selections for your free vend event.
- This Menu is different from Winner mode and all selections chosen will be free for the times and days set.
- **Save your changes often by choosing save this event. If you exit without choosing save this event your changes will be lost!**

Create Free Vend Event				Create Free Vend Event			
Save This Event		End Date	12/31/2050				
Remove This Event		Start Time	00:00				
Enable State	<input type="checkbox"/>	Stop Time	00:00				
Frequency	Daily	Days of Week					
Start Date	01/01/1974	By UPC	<input type="checkbox"/>				
End Date	12/31/2050	Selections	nothing selected				
1/2	v11.0.2 b93	08/23/2018 20:18:38	Temp: N/A	2/2	v11.0.2 b93	08/23/2018 20:19:04	Temp: N/A

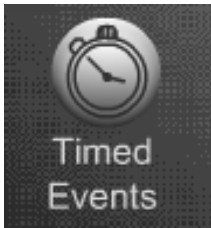

Timed Events

Time of Day Events – Inhibit

Inhibit

- The Inhibit menu allows you to set times and/or day(s) when specific selections or all selections in the machine are not available for purchase.
- You can set multiple Inhibit events per day if necessary.
- The menu bars on the right contain all the options that need to be set up for your event and may change depending on your selections.
- **Save your changes often by choosing save this event. If you exit without choosing save this event your changes will be lost!**

1/2 v11.0.2 b93 08/23/2018 20:19:28 Temp: N/A

2/2 v11.0.2 b93 08/23/2018 20:19:40 Temp: N/A

Field	Value
Save This Event	[Button]
Remove This Event	[Button]
Enable State	off <input type="checkbox"/> on <input type="checkbox"/>
Frequency	Daily
Start Date	01/01/1974
End Date	12/31/2050
End Date	12/31/2050
End Date	12/31/2050
Start Time	00:00
Stop Time	00:00
Days of Week	[Field]
By UPC	off <input type="checkbox"/> on <input type="checkbox"/>
Selections	nothing selected

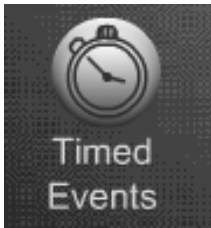

Timed Events

Time of Day Events – Promotions

Promotions

- Promotions allows you to choose one or more pre-defined promotions to offer the customer a discount for purchasing multiple items during a single transaction.
- Each promotion has a pre-programmed advertisement that advises the customer that these promotions are available.
- The recommended maximum number of Promotions stored is six.

Available Pre-Defined Promotions

Buy any 2 and save X

Buy any Snack and any Drink and Save X*

Buy any Bar and any Drink and Save X*

Buy any 2 Snacks and Save X

Buy any 2 Bars and Save X

Buy any 2 Drinks and Save X*

Buy any 2 Items and Get 1 FREE (shown above)

Buy any 3 Items and Save X

Buy Any Food Item with a Snack and a Drink and Save X*

* Combo Only

Back Home Test

Create Promotion Event

Save This Event

Remove This Event

Enable State off On

Promotion type
Choose a Type

Price Adjust Type
Discount Value

Discount Amount
\$0.00

1/2 v11.0.2 b93 08/23/2018 20:20:02 Temp: N/A

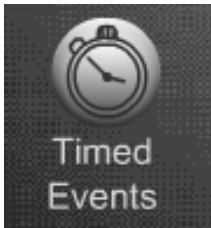

Timed Events Backup Events

Backup Events

- The backup Events Menu allows you to create a backup of the events you have created.
- This Menu also allows you to program the time and day or days you wish to backup the Events.

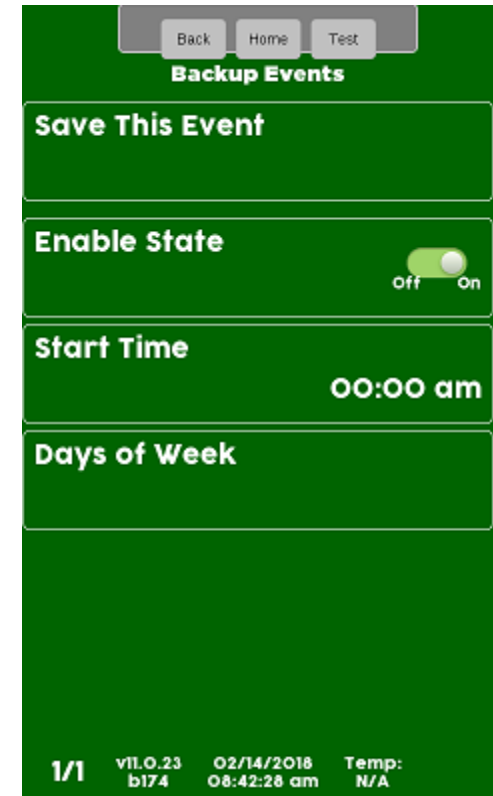
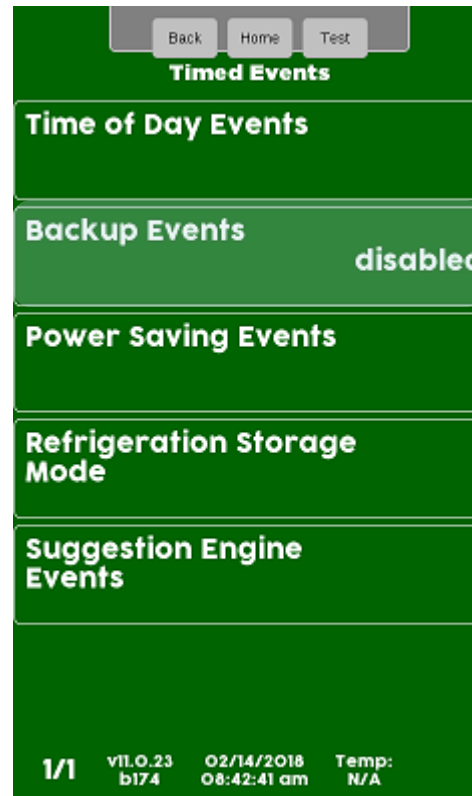

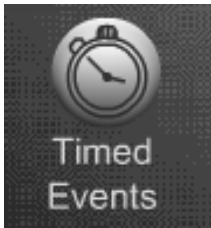

Timed Events

Power Saving Events

Power Saving Events

- The Power Saving Events Menu allows you to create events where the lighting will turn off to save energy.
- This Menu allows you to program the time and day or days you wish the Power Saving Events to be active.
- There is one additional feature that is only in the Power Saving Events Menu. This feature allows you to set the number of minutes of inactivity before the machine goes into Power Saving Mode.
- Inactivity minutes are settable from 1 to 600.
- **Save your changes often by choosing save this event. If you exit without choosing save this event your changes will be lost!**

Back Home Test

Create PowerSave Event

Save This Event

Remove This Event

Enable State off on

Frequency Daily

Start Time 00:00 am

Stop Time 00:00 am

1/2 VII.O.23 b174 02/14/2018 08:43:29 am Temp: N/A

Back Home Test

Create PowerSave Event

Enable State off on

Frequency Daily

Start Time 00:00 am

Stop Time 00:00 am

Days of Week

Inactivity Minutes 0

2/2 VII.O.23 b174 02/14/2018 08:43:40 am Temp: N/A

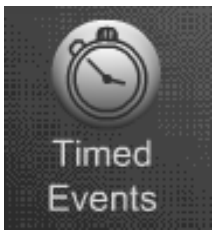

Timed Events

Create New Event

Touch the type of event you wish to Create

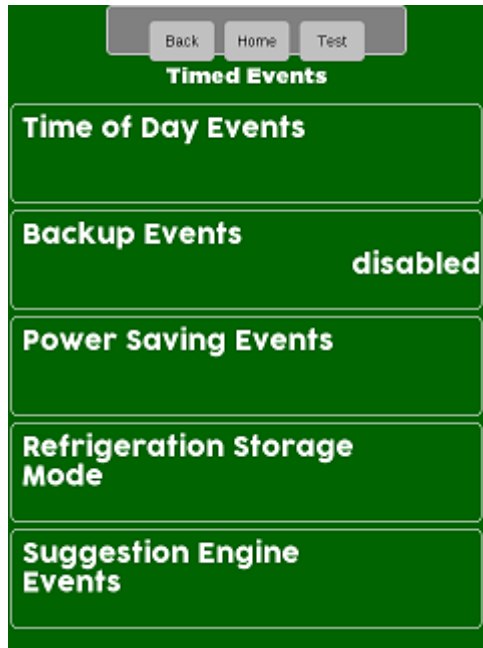

If you choose Time of Day you will need to choose the event type, all other choices will take you to the next screen

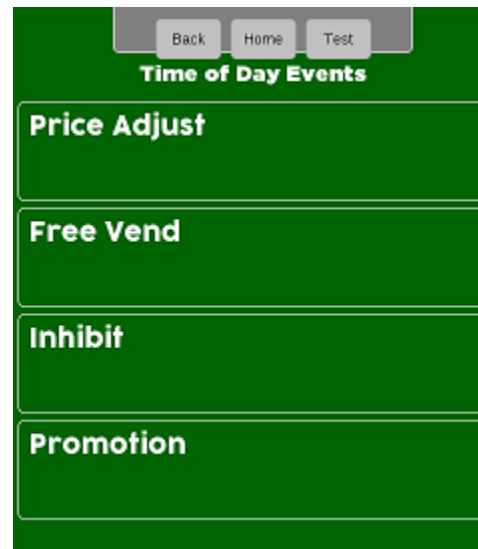

Touch Create New Event or select an existing event to modify.

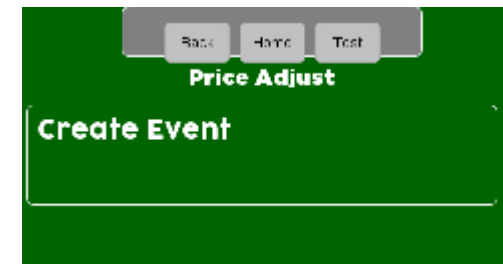

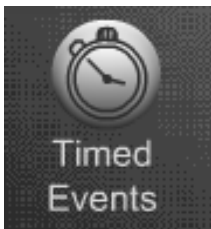

Timed Events

Create New Event

Program menu all options before saving.
Once the event details are programmed
Touch Save this event to save or your
changes will be lost!

Touch Remove this Event to delete the event
you are working on. Be aware if you remove
event 1 and you have multiple events, what
was event 2, now will become event 1. Also
there is no conformation screen for removing
an event so be careful!

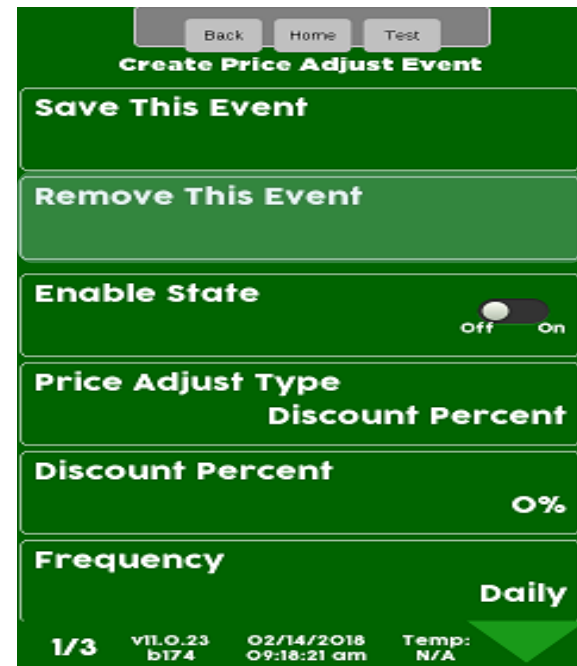
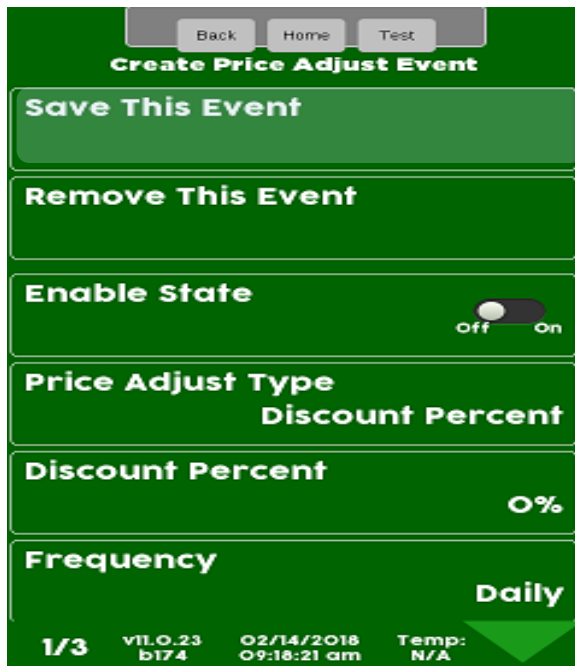

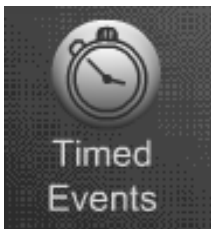

Timed Events

Enabling & Frequency of the Event

Touch Enable State to toggle the state of the event between Off and On. Choosing off allows an event to remain stored in the machine for future use – it is not necessary to remove the event.

If the event involves changing prices touch price adjust type and a screen will pop up with the type of price adjustment options to choose from. Press Accept to Save

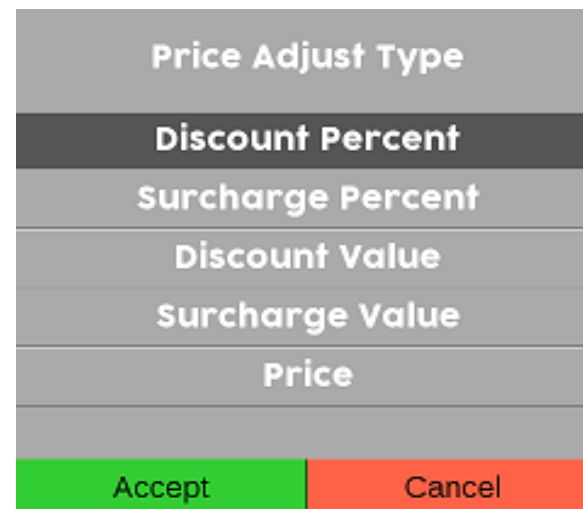
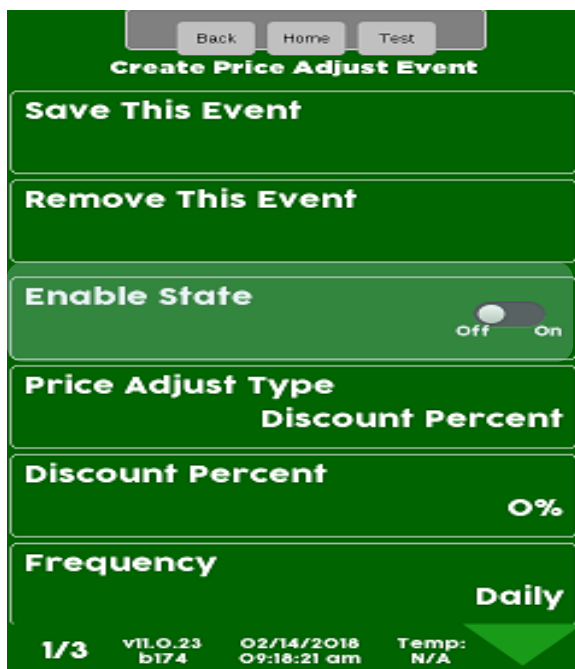

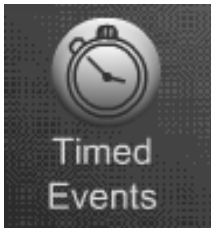

Timed Events

Enabling & Frequency of the Event

Touch the Discount Percent, Value or Price depending on what you set the in the last menu to set the discount amount. If the Event does not involve money this menu will not appear.

Touch the display to toggle the Frequency of the event between Daily and Weekly.

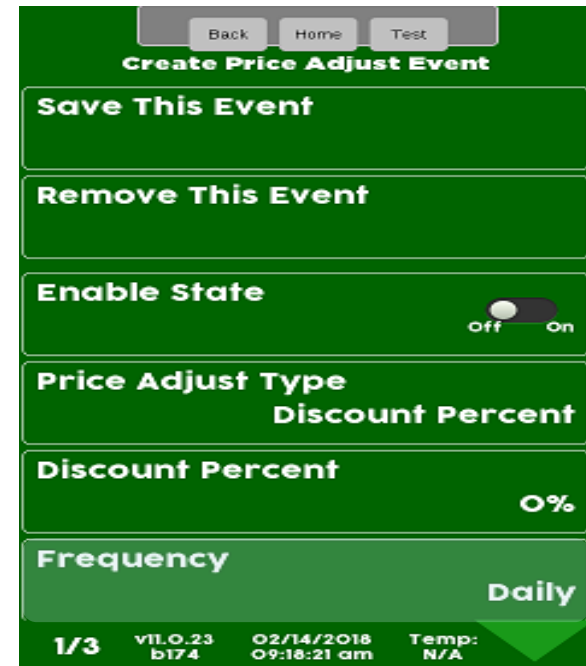
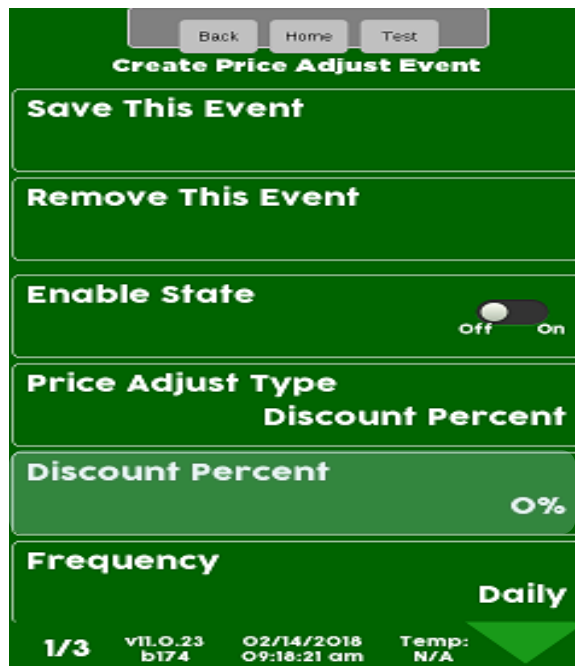

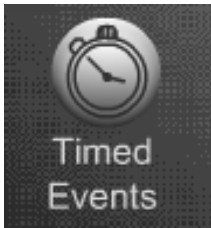

Timed Events

Frequency of the Event

Note: When you choose Daily you have a choice of a start time, stop time and days of the week

Frequency		Daily
<div style="text-align: center;"> Back Home Test </div> <p style="text-align: center;">Create Price Adjust Event</p>		
Start Date	01/01/1974	
End Date	12/31/2050	
Start Time	00:00 am	
Stop Time	00:00 am	
Days of Week		
By UPC	<input type="checkbox"/> off <input checked="" type="checkbox"/> on	
2/3	VIL0.23 b174	02/14/2018 09:18:37 am Temp: N/A

Note: When you choose Weekly you have a choice of a start day and End Day also.

Frequency		Weekly
Start Date	01/01/1974	
End Date	12/31/2050	
Start Day	monday	
End Day	sunday	
Start Time	00:00 am	
Stop Time	00:00 am	
By UPC	<input type="checkbox"/> off <input checked="" type="checkbox"/> on	
Selections	nothing selected	
3/3	VIL0.23 b174	02/14/2018 09:59:58 am Temp: N/A

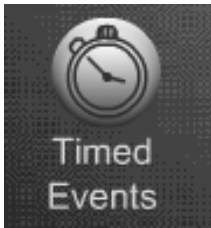

Timed Events

Setting Start/Stop Time & Date

- The Start Date is the date the event will start.
- The stop date is the Date the Event will stop and no longer be active. If no End Date is set the Event will have not end. The Event will continue as long as the event is enabled.
- Touch Start Time on the display to enter the time you want the event to start. As an example, if this is an Inhibit Event set for all selections, this is the time the machine will stop accepting money.
- The Stop time is when the Inhibit Event is to stop and the machine will start taking money again.

A screenshot of a mobile application interface for creating a price adjust event. The screen has a green background with white text and buttons. At the top, there are three buttons: "Back", "Home", and "Test". Below them is the title "Create Price Adjust Event" with a green arrow pointing right. The main content consists of several stacked fields:

- Start Date**: 01/01/1974
- End Date**: 12/31/2050
- Start Time**: 00:00 am
- Stop Time**: 00:00 am
- Days of Week**: (empty field)
- By UPC**: (empty field) with a toggle switch set to "Off".

At the bottom, there is a status bar with the text "2/3", "V1LO.23 b174", "02/14/2018 09:18:37 am", and "Temp: N/A".

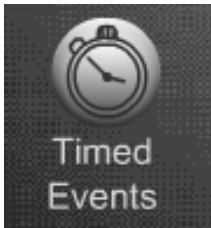

Timed Events

Setting up Selections for the Event

Leaving the By UPC toggle in the off position will cause the menu bar below it to say selections and you can choose which selection will be active for this timed event.

Changing the By UPC toggle to the On position will cause the menu bar below it to say by UPC and you can choose which UPC codes will be active for this timed event.

Back Home Test

Create Price Adjust Event

Start Day **monday**

End Day **sunday**

Start Time **00:00 am**

Stop Time **00:00 am**

By UPC Off On

Selections **nothing selected**

3/3 v11.O.23 02/14/2018 Temp: b174 09:59:58 am N/A

Back Home Test

Create Price Adjust Event

End Date **12/31/2050**

Start Time **00:00 am**

Stop Time **00:00 am**

Days of Week

By UPC Off On

UPC/EAN Codes **nothing selected**

3/3 v11.O.23 02/15/2018 Temp: b174 05:17:55 am N/A

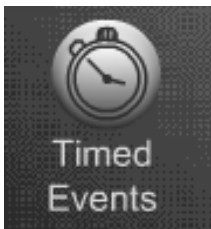

Timed Events

Setting up Selections for the Event

If using selection numbers for this event touch the selections menu bar

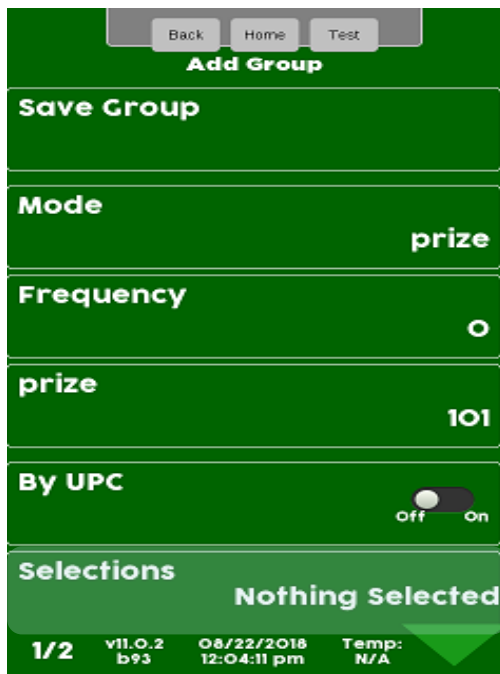

Choose a tray for items you want to initiate the Event



Touch the menu bar to Select All, Clear All or add a checkmark to the selections to work with Winner Mode. Press Back to exit and choose another tray to add selections to if desired.

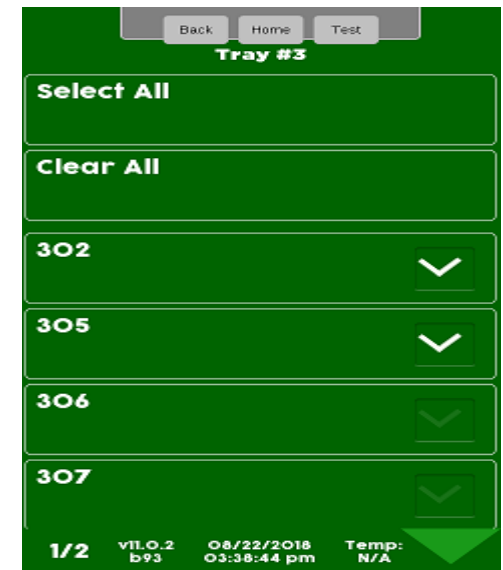

Atlas H Board Layout

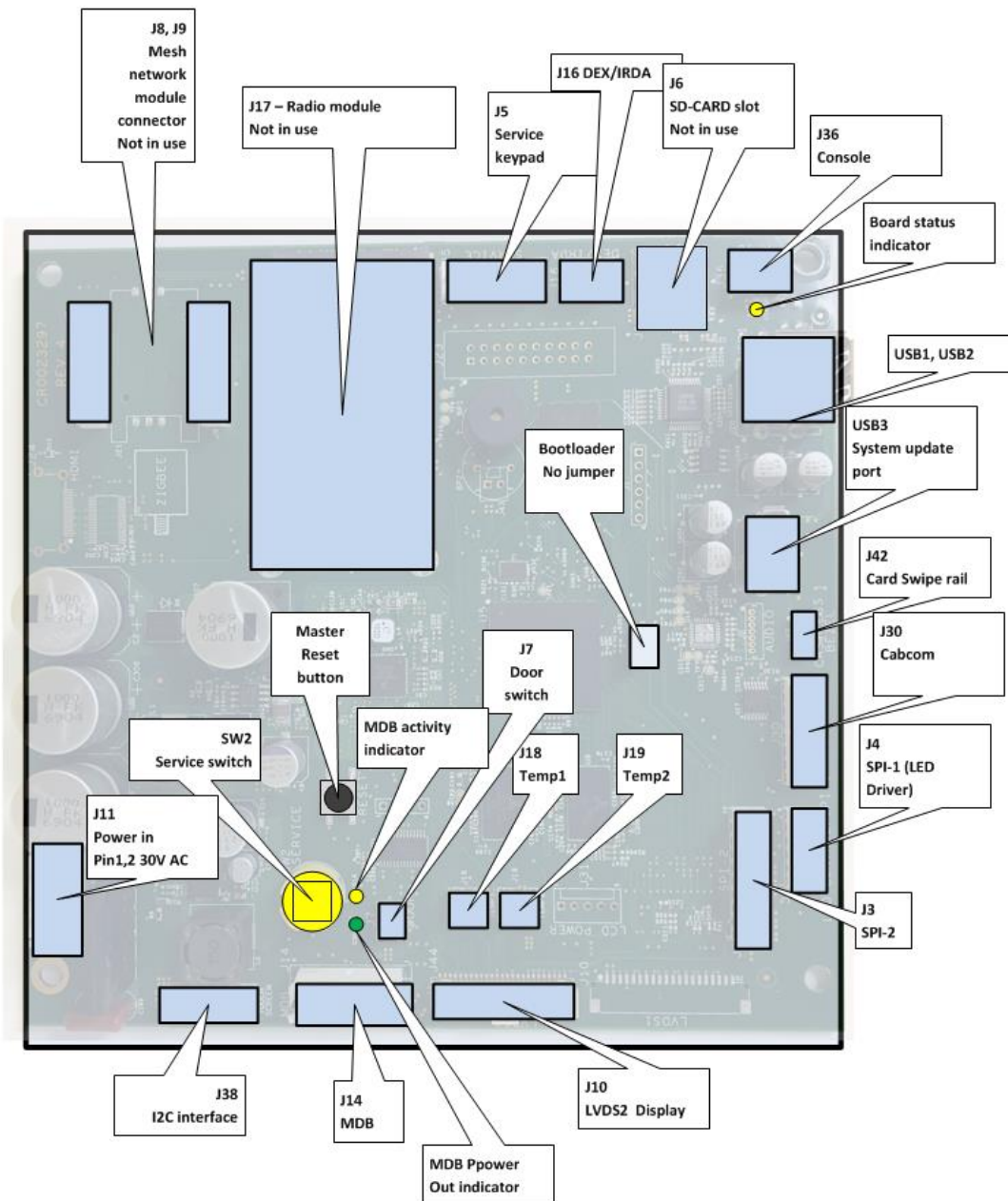

Software Licenses

GNU General Public License (GPL), version 2

GNU GENERAL PUBLIC LICENSE

Version 2, June 1991

Copyright (C) 1989, 1991 Free Software Foundation, Inc. 51 Franklin Street, Fifth Floor, Boston, MA 02110-1301, USA Everyone is permitted to copy and distribute verbatim copies of this license document, but changing it is not allowed. **Preamble**

The licenses for most software are designed to take away your freedom to share and change it. By contrast, the GNU General Public License is intended to guarantee your freedom to share and change free software—to make sure the software is free for all its users. This General Public License applies to most of the Free Software Foundation's software and to any other program whose authors commit to using it. (Some other Free Software Foundation software is covered by the GNU Lesser General Public License instead.) You can apply it to your programs, too.

When we speak of free software, we are referring to freedom, not price. Our General Public Licenses are designed to make sure that you have the freedom to distribute copies of free software (and charge for this service if you wish), that you receive source code or can get it if you want it, that you can change the software or use pieces of it in new free programs; and that you know you can do these things.

To protect your rights, we need to make restrictions that forbid anyone to deny you these rights or to ask you to surrender the rights. These restrictions translate to certain responsibilities for you if you distribute copies of the software, or if you modify it.

For example, if you distribute copies of such a program, whether gratis or for a fee, you must give the recipients all the rights that you have. You must make sure that they, too, receive or can get the source code. And you must show them these terms so they know their rights.

We protect your rights with two steps: (1) copyright the software, and (2) offer you this license which gives you legal permission to copy, distribute and/or modify the software.

Also, for each author's protection and ours, we want to make certain that everyone understands that there is no warranty for this free software. If the software is modified by someone else and passed on, we want its recipients to know that what they have is not the original, so that any problems introduced by others will not reflect on the original authors' reputations.

Finally, any free program is threatened constantly by software patents. We wish to avoid the danger that redistributors of a free program will individually obtain patent licenses, in effect making the program proprietary. To prevent this, we have made it clear that any patent must be licensed for everyone's free use or not licensed at all.

The precise terms and conditions for copying, distribution and modification follow.

TERMS AND CONDITIONS FOR COPYING, DISTRIBUTION AND MODIFICATION

0. This License applies to any program or other work which contains a notice placed by the copyright holder saying it may be distributed under the terms of this General Public License. The "Program", below, refers to any such program or work, and a "work based on the Program" means either the Program or any derivative work under copyright law: that is to say, a work containing the Program or a portion of it, either verbatim or with modifications and/or translated into another language. (Hereinafter, translation is included without limitation in the term "modification".) Each licensee is addressed as "you".

Activities other than copying, distribution and modification are not covered by this License; they are outside its scope. The act of running the Program is not restricted, and the output from the Program is covered only if its contents constitute a work based on the Program (independent of having been made by running the Program). Whether that is true depends on what the Program does.

1. You may copy and distribute verbatim copies of the Program's source code as you receive it, in any medium, provided that you conspicuously and appropriately publish on each copy an appropriate copyright notice and disclaimer of warranty; keep intact all the notices that refer to this License and to the absence of any warranty; and give any other recipients of the Program a copy of this License along with the Program.

You may charge a fee for the physical act of transferring a copy, and you may at your option offer warranty protection in exchange for a fee.

2. You may modify your copy or copies of the Program or any portion of it, thus forming a work based on the Program, and copy and distribute such modifications or work under the terms of Section 1 above, provided that you also meet all of these conditions:

a) You must cause the modified files to carry prominent notices stating that you changed the files and the date of any change.

b) You must cause any work that you distribute or publish, that in whole or in part contains or is derived from the Program or any part thereof, to be licensed as a whole at no charge to all third parties under the terms of this License.

c) If the modified program normally reads commands interactively when run, you must cause it, when started running for such interactive use, to print or display an announcement including an appropriate copyright notice and a notice that there is no warranty (or else, saying that you provide a warranty) and that users may redistribute the program under these conditions, and telling the user how to view a copy of this License. (Exception: if the Program itself is interactive but does not normally print such an announcement, your work based on the Program is not required to print an announcement.)

These requirements apply to the modified work as a whole. If identifiable sections of that work are not derived from the Program, and can be reasonably considered independent and separate works in themselves, then this License, and its terms, do not apply to those sections when you distribute them as separate works. But when you distribute the same sections as part of a whole which is a work based on the Program, the distribution of the whole must be on the terms of this License, whose permissions for other licensees extend to the entire whole, and thus to each and every part regardless of who wrote it.

Thus, it is not the intent of this section to claim rights or contest your rights to work written entirely by you; rather, the intent is to exercise the right to control the distribution of derivative or collective works based on the Program.

In addition, mere aggregation of another work not based on the Program with the Program (or with a work based on the Program) on a volume of a storage or distribution medium does not bring the other work under the scope of this License.

3. You may copy and distribute the Program (or a work based on it, under Section 2) in object code or executable form under the terms of Sections 1 and 2 above provided that you also do one of the following:

a) Accompany it with the complete corresponding machine-readable source code, which must be distributed under the terms of Sections 1 and 2 above on a medium customarily used for software interchange; or,

b) Accompany it with a written offer, valid for at least three years, to give any third party, for a charge no more than your cost of physically performing source distribution, a complete machine-readable copy of the corresponding source code, to be distributed under the terms of Sections 1 and 2 above on a medium customarily used for software interchange;

c) Accompany it with the information you received as to the offer to distribute corresponding source code. This alternative is allowed only for noncommercial distribution and only if you received the program in object code or executable form with such an offer, in accord with Subsection b above.)

The source code for a work means the preferred form of the work for making modifications to it. For an executable work, complete source code means all the source code for all modules it contains, plus any associated interface definition files, plus the scripts used to control compilation and installation of the executable. However, as a special exception, the source code distributed need not include anything that is normally distributed (in either source or binary form) with the major components (compiler, kernel, and so on) of the operating system on which the executable runs, unless that component itself accompanies the executable.

If distribution of executable code is made by offering access to copy from a designated place, then offering equivalent access to copy the source code from the same place counts as distribution of the source code, even though third parties are not compelled to copy the source along with the object code.

4. You may not copy, modify, sublicense, or distribute the Program except as expressly provided under this License. Any attempt otherwise to copy, modify, sublicense or distribute the Program is void, and will automatically terminate your rights under this License. However, parties who have received copies, or rights, from you under this License will not have their licenses terminated so long as such parties remain in full compliance.

5. You are not required to accept this License, since you have not signed it. However, nothing else grants you permission to modify or distribute the Program or its derivative works. These actions are prohibited by law if you do not accept this License. Therefore, by modifying or distributing the Program (or any work based on the Program), you indicate your acceptance of this License to do so, and all its terms and conditions for copying, distributing or modifying the Program or works based on it.

6. Each time you redistribute the Program (or any work based on the Program), the recipient automatically receives a license from the original licensor to copy, distribute or modify the Program subject to these terms and conditions. You may not impose any further restrictions on the recipients' exercise of the rights granted herein. You are not responsible for enforcing compliance by third parties to this License.

7. If, as a consequence of a court judgment or allegation of patent infringement or for any other reason (not limited to patent issues), conditions are imposed on you (whether by court order, agreement or otherwise) that contradict the conditions of this License, they do not excuse you from the conditions of this License. If you cannot distribute so as to satisfy simultaneously your obligations under this License and any other pertinent obligations, then as a consequence you may not distribute the Program at all. For example, if a patent license would not permit royalty-free redistribution of the Program by all those who receive copies directly or indirectly through you, then the only way you could satisfy both it and this License would be to refrain entirely from distribution of the Program.

If any portion of this section is held invalid or unenforceable under any particular circumstance, the balance of the section is intended to apply and the section as a whole is intended to apply in other circumstances.

It is not the purpose of this section to induce you to infringe any patents or other property right claims or to contest validity of any such claims; this section has the sole purpose of protecting the integrity of the free software distribution system, which is implemented by public license practices. Many people have made generous contributions to the wide range of software distributed through this system in reliance on consistent application of that system; it is up to the author/donor to decide if he or she is willing to distribute software through any other system and a licensee cannot impose that choice.

This section is intended to make thoroughly clear what is believed to be a consequence of the rest of this License.

8. If the distribution and/or use of the Program is restricted in certain countries either by patents or by copyrighted interfaces, the original copyright holder who places the Program under this License may add an explicit geographical distribution limitation excluding those countries, so that distribution is permitted only in or among countries not thus excluded. In such case, this License incorporates the limitation as if written in the body of this License.

9. The Free Software Foundation may publish revised and/or new versions of the General Public License from time to time. Such new versions will be similar in spirit to the present version, but may differ in detail to address new problems or concerns.

Each version is given a distinguishing version number. If the Program specifies a version number of this License which applies to it and "any later version", you have the option of following the terms and conditions either of that version or of any later version published by the Free Software Foundation. If the Program does not specify a version number of this License, you may choose any version ever published by the Free Software Foundation.

10. If you wish to incorporate parts of the Program into other free programs whose distribution conditions are different, write to the author to ask for permission. For software which is copyrighted by the Free Software Foundation, write to the Free Software Foundation; we sometimes make exceptions for this. Our decision will be guided by the two goals of preserving the free status of all derivatives of our free software and of promoting the sharing and reuse of software generally.

NO WARRANTY

11. BECAUSE THE PROGRAM IS LICENSED FREE OF CHARGE, THERE IS NO WARRANTY FOR THE PROGRAM, TO THE EXTENT PERMITTED BY APPLICABLE LAW. EXCEPT WHEN OTHERWISE STATED IN WRITING THE COPYRIGHT HOLDERS AND/OR OTHER PARTIES PROVIDE THE PROGRAM "AS IS" WITHOUT WARRANTY OF ANY KIND, EITHER EXPRESSED OR IMPLIED, INCLUDING BUT NOT LIMITED TO, THE IMPLIED WARRANTIES OF MERCHANTABILITY AND FITNESS FOR A PARTICULAR PURPOSE. THE ENTIRE RISK AS TO THE QUALITY AND PERFORMANCE OF THE PROGRAM IS WITH YOU. SHOULD THE PROGRAM PROVE DEFECTIVE, YOU ASSUME THE COST OF ALL NECESSARY SERVICING, REPAIR OR CORRECTION.

12. IN NO EVENT UNLESS REQUIRED BY APPLICABLE LAW OR AGREED TO IN WRITING WILL ANY COPYRIGHT HOLDER, OR ANY OTHER PARTY WHO MAY MODIFY AND/OR REDISTRIBUTE THE PROGRAM AS PERMITTED ABOVE, BE LIABLE TO YOU FOR DAMAGES, INCLUDING ANY GENERAL, SPECIAL, INCIDENTAL OR CONSEQUENTIAL DAMAGES ARISING OUT OF THE USE OF THE PROGRAM (INCLUDING BUT NOT LIMITED TO LOSS OF DATA OR DATA BEING RENDERED INACCURATE OR LOSSES SUSTAINED BY YOU OR THIRD PARTIES OR A FAILURE OF THE PROGRAM TO OPERATE WITH ANY OTHER PROGRAMS), EVEN IF SUCH HOLDER OR OTHER PARTY HAS BEEN ADVISED OF THE POSSIBILITY OF SUCH DAMAGES.

END OF TERMS AND CONDITIONS

How to Apply These Terms to Your New Programs

If you develop a new program, and you want it to be of the greatest possible use to the public, the best way to achieve this is to make it free software which everyone can redistribute and change under these terms.

To do so, attach the following notices to the program. It is safest to attach them to the start of each source file to most effectively convey the exclusion of warranty; and each file should have at least the "copyright" line and a pointer to where the full notice is found.

one line to give the program's name and an idea of what it does. Copyright (C) yyyy name of author This program is free software; you can redistribute it and/or modify it under the terms of the GNU General Public License as published by the Free Software Foundation; either version 2 of the License, or (at your option) any later version. This program is distributed in the hope that it will be useful, but WITHOUT ANY WARRANTY; without even the implied warranty of MERCHANTABILITY or FITNESS FOR A PARTICULAR PURPOSE. See the GNU General Public License for more details. You should have received a copy of the GNU General Public License along with this program; if not, write to the Free Software Foundation, Inc., 51 Franklin Street, Boston, MA 02110-1301, USA. Also add information on how to contact you by electronic and paper mail.

If the program is interactive, make it output a short notice like this when it starts in an interactive mode:

Gnomovision version 69, Copyright (C) year name of author Gnomovision comes with ABSOLUTELY NO WARRANTY; for details type `show w'. This is free software, and you are welcome to redistribute it under certain conditions; type `show c' for details. The hypothetical commands `show w' and `show c' should show the appropriate parts of the General Public License. Of course, the commands you use may be called something other than `show w' and `show c'; they could even be mouse-clicks or menu items—whatever suits your program.

You should also get your employer (if you work as a programmer) or your school, if any, to sign a "copyright disclaimer" for the program, if necessary. Here is a sample; alter the names:

Yoodyne, Inc., hereby disclaims all copyright interest in the program "Gnomovision" (which makes passes at compilers) written by James Hacker. signature of Ty Coon, 1 April 1989 Ty Coon, President of Vice This General Public License does not permit incorporating your program into proprietary programs. If your program is a subroutine library, you may consider it more useful to permit linking proprietary applications with the library. If this is what you want to do, use the GNU Lesser General Public License instead of this License.

- Complete text of v2 of the GPL may be found online at <http://www.gnu.org/licenses/gpl-2.0.html>.

